

Installation and user guide

EMOTEC B6000



GB

Made in Germany



IP x4

Druck Nr. 29342340en 40.07

English

Table of Contents

| | |
|---|----|
| Package contents | 3 |
| Technical data | 3 |
| General information concerning sauna bathing | 4 |
| General safety precautions | 5 |
| Assembly of the control unit..... | 6 |
| Wall mounting | 6 |
| Electrical connection | 7 |
| Connecting the sauna oven | 7 |
| Connecting the sauna lamp | 7 |
| Connecting the sensor lines..... | 8 |
| Mounting the oven sensor..... | 8 |
| Operation | 9 |
| Button Functions | 9 |
| Symbol description..... | 9 |
| Unit initialization..... | 10 |
| Finnish sauna operation | 11 |
| Temperature indicator | 11 |
| Default parameters | 11 |
| Heating time..... | 11 |
| Important notes when programming | 12 |
| Delayed startup | 12 |
| Heating time limiter | 13 |
| Changing the default temperature | 14 |
| Programming fan operation | 15 |
| Programming current time | 16 |
| The control unit switch | 17 |
| Error display..... | 17 |
| Additional errors not displayed and their causes: | 17 |
| Wiring diagram..... | 18 |
| Service Address:..... | 19 |
| Guarantee | 19 |

Package contents

(subject to change)

Included with the control unit are:

1. An heater-sensor board with overheat shutoff protection, KTY-sensors with sensor housing , two 3x25 mm fastening screws and a 1,7 m long sensor cable, red and white.
2. A plastic bag with three 4 x 20 mm fastening screws.
3. A replacement overheat protection module.

Technical data

| | |
|------------------------------------|---|
| Rated voltage: | 400 V 3 N 50 Hz AC |
| Schaltleistung: | max 9 kW resistive load (AC 1 operation) upgrade to 36 kW possible through connection to power control units |
| Heating time shut-off: | 6 h |
| Display: | LCD, backlit |
| Protection type: | IPx4 in accordance with DIN 40050 (German Standards Institution), splashproofing |
| Control range, sauna operation: | 30 to 115°C |
| Sensor system: | KTY-Sensor with overheat shutoff protection at 139° C |
| Control characteristics: | digital two-step control of -20° C - max. cab temperature |
| Fan capacity:: | max. 100 W, max. 450 mA (only fan without capacitor) |
| Light: | max. 100 W, max. 450 mA (only ohm resistive load) |



Fuse protection on the light and the ventilation can be a maximum of 1A delay action. There is a danger of fire if greater fuse protection is used!

| | |
|----------------------------|---|
| Error display: | blinking warning triangle and error code on LCD |
| Environmental temperature: | 0°C to +40°C |
| Storage temperatures: | -20°C to +70°C |

General information concerning sauna bathing

Dear customer,

with purchase of this sauna control unit you opted for a superior quality, high-tech electronic device which was developed and manufactured according to the highest standards and guidelines.

Please note that an optimal interaction of sauna cabin, sauna oven and sauna control unit is mandatory for a pleasant sauna climate in your cabin.

With this superior sauna control unit you can „operate“ your sauna system, and thanks to the many individual programming settings you will surely soon find the setting that suits you best.

Perception in the sauna is very subjective, therefore it really requires your own perception, or that of your family to find the most suitable settings.

By default the finnish sauna is preset to 95°C. For steam operation the values are set to 60°C and 60% humidity.

The following operation instructions describe how to pre-select „your“ climate in the cabin. Read these instructions carefully, so that you quickly and easily find your way through the programming process.

Please note the variation in temperatures in the cabin while sauna bathing. The hottest area is directly under the cabin ceiling, whereas there is a steady temperature gradient towards the floor of the cabin. Inversely, the relative humidity is lowest directly under the cabin ceiling and the highest on the cabin floor.

For safety reasons the temperature sensor with the overheat safety shutdown is located on the cabin ceiling above the oven, since this is the hottest area in the cabin.

Therefore there will always be temperature variations between the temperature sensor of the control unit and the thermometer in the cabin.

For the cabin light use only light bulbs. Do not use fluorescent lamps, energy saving lamps and gas discharge lamps.

For example, when pre-setting the cabin temperature to 100°C, the thermometer inside the cabin may easily show 85°C - 90°C. This complies with the typical climate inside the cabin.

Always observe hygiene. Always use hand- or bathing towels, to avoid getting perspiration on the wood.

To protect your cabin from possible damages due to steam operation, we recommend reheating or drying the cabin after every steam bath.



In addition, a fan can help to dissipate used humid air in badly ventilated areas.

To avoid the perception of draft, you should avoid using any ventilation system while sauna bathing. It should only be used if recommended by the cabin manufacturer



Always make sure no objects are located on the sauna oven before starting the heating cycle.

General safety precautions

- his device has not been designed for being used by persons (including children) that are physically or mentally handicapped or have sensory disabilities. Moreover, it is not allowed to use this device without sufficient experience and/or knowledge, unless these persons will be supervised by persons responsible for their security or in case they have been instructed how to use this device.
- Children are to be supervised in order to make sure that they do not play with this device.
-  Attention: It is forbidden to install the control box in a closed switch cabinet or behind a wooden panelling!
- The electrical installation may be done only by a qualified electrical technician.
- You must comply with the regulations of your power supply company and applicable VDE regulations (DIN VDE 0100).
-  **WARNING:** Never attempt repairs or installations yourself, as this could result in serious injury or death. Only a qualified technician may remove the housing cover.
- Please note the dimensions in the assembly instructions, especially when installing the temperature sensor. The temperature above the oven is critical for the temperature setting. The temperature can be held within operating parameters and a minimal temperature gradient inside the bench area of the sauna cabin can be achieved only if unit is assembled correctly.
- The device may only be used as intended as a control unit for sauna ovens up to 9 kW. (Up to 36 kW when combined with a breaking capacitor).
- Completely disconnect the control unit from the electrical circuit, i.e. flip all circuit breakers or the main circuit breaker during each installation or repair.
- Please note the safety and installation information from the sauna oven manufacturer.

Assembly of the control unit

Wall mounting

Mount the control unit outside the sauna cabin only. The most practical mounting point would be the wall area onto which the sauna oven is mounted on the inside, except on the outside of the cabin. If electrical conduits are present, mount the control unit accordingly. To mount the control unit, please follow these instructions:

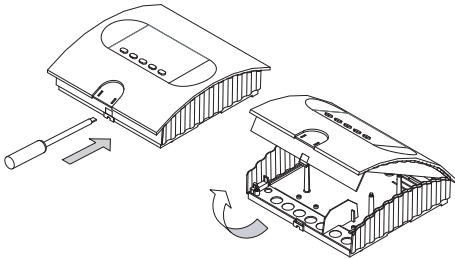

Illust. 1

1. Remove the cover of the control unit. To do this press the fastening tab inwards with a flat screwdriver and remove the housing top by pivoting it upwards (Illustr.1). Drill the threaded holes for the included 4 x 20 mm wood screws according to Illust. 3 & 3.1.
2. Insert one of the wood screws into the upper middle hole. This screw will be the mounting point for the control unit. Make sure the screw is projecting out from wall about 3 mm. (Illust. 3.2)
3. Hang the control unit onto the 3 mm projecting screw. Insert the included rubber sleeves into the openings on the back side of the housing and lead the electrical cable through these openings. Screw the lower part of the housing onto the cabin wall using the lower threaded holes. (Illust. 4)

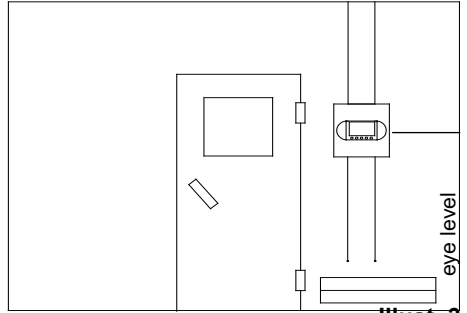

Illust. 3

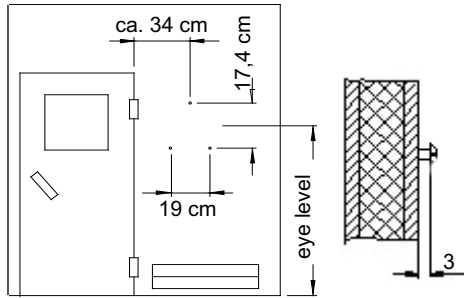

Illust. 3.1

Illust. 3.2

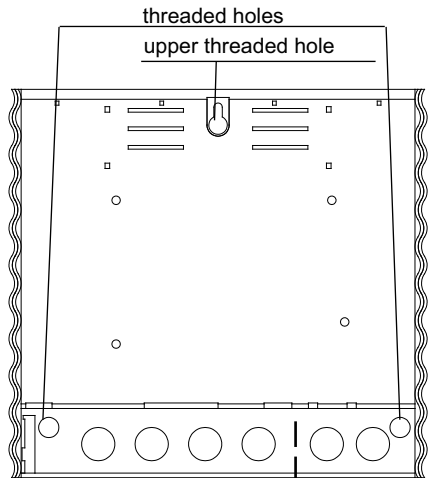

feed-through channel for
power supply lead wire
oven supply line
vaporizer supply line
lamp
fan

feed-through channel for
sensor lines

Illust. 4

Electrical connection



The electrical connection may only be done by a qualified electrical technician under authority of the regulations of the local power supply company and those of the VDE.

In general, there can only be one permanent connection to the power supply network, to include a device which allows the unit to be disconnected from the power source with a contact distance of at least 3 mm from all terminals.

All electrical installations and connector cables inside the cabin must be able to withstand temperatures up to 140°C. Please use the table below to determine the required cable diameters for this task.

Attach the power supply lead wire as shown in Illust. 5 to the power supply terminals of the control unit. Connection instructions are printed directly in the control unit.

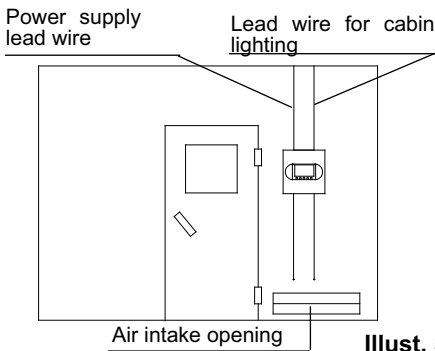

Illust. 5

Connecting the sauna oven

Assemble the sauna oven according to the instructions provided by the manufacturer in front of the air intake opening.

Lead the silicon lines through the electrical conduits to their respective terminals on the control unit and connect them according to the circuit diagram printed there.

Please note: If no electrical conduits are present, drill a hole with a diameter of 10 mm next to the air intake opening and lead the oven control cables through this hole to their corresponding terminals (U V W) in the control unit. To protect the silicon lines from external influences, install them in a shielded fashion. For this task, use a fitting cable or simple PVC conduit and lead the silicon cable through it to the control unit.

Connecting the sauna lamp

The sauna lamp must be splashproof (by Standard IPx4) and resistant to ambient temperature. The sauna lamp can be mounted anywhere except in the area of the rising hot air above the oven.

| Connector capacity in kW | Appropriate for cabin sizes (in m ³) | minimum diameter in mm ² (copper wire) connection to 380 V 3N AC | | |
|--------------------------|--|---|---------------------------------------|---------------------------|
| | | Power supply lead wire to the control unit | Connector cable control unit for oven | safety fuse capacity in A |
| 4,5 | 4 - 6 | 5 x 2,5 mm ² | 5 x 1,5 mm ² | 3 x 16 |
| 6,0 | 6 - 10 | 5 x 2,5 mm ² | 5 x 1,5 mm ² | 3 x 16 |
| 7,5 | 8 - 12 | 5 x 2,5 mm ² | 5 x 1,5 mm ² | 3 x 16 |
| 9,0 | 10 - 14 | 5 x 2,5 mm ² | 5 x 1,5 mm ² | 3 x 16 |

Connecting the sensor lines

ou should not install sensor and power supply lines together, or lead them through the same conduit. This can lead to interferences in the electronics, such as „fluttering“ in the relays. If it is absolutely necessary to install them together, or the wire is longer than 3m, you should use a shielded sensor line such as the LIYLY-O x 0.5 mm²). Connect the shielding to mass in the control unit.

Please note that the following measurements are based on values provided by the unit quality assurance by the European Standard EN 60335-2-53. In principle, you must mount the oven sensor where temperatures are expected to be the highest. Illust. 7 gives you an overview of the mounting point of the sensor..

Mounting the oven sensor

1. Mount the oven sensor in cabins up to 2 x 2m according to Illust. 7 and 8, in larger cabins according to Illust. 7 and 9.

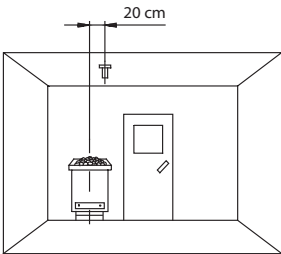

Illust. 7

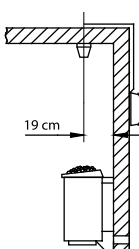

Illust. 8

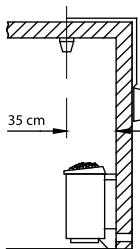

Illust. 9

2. Drill a hole to lead the cable through, preferably through the middle of one of the wooden boards.
3. Lead the sensor cable through the drilled hole and attach it to the sensor line according to Illust. 10.
4. Attach the lines for the shutoff (white) and the temperature sensor (red) according to Illust. 11 to the sensor board. Then insert the sensor board into the housing.
5. After you are finished installing and have made sure the control unit is functioning properly, check the line for overheat shutoff protection for short circuits. To do this, release one of the white lines in the sensor housing. The safety relay of the control unit should now fall; i.e. the heating circuit should now be interrupted.

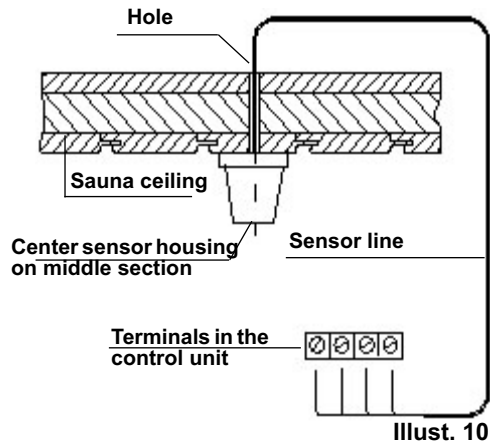

Illust. 10

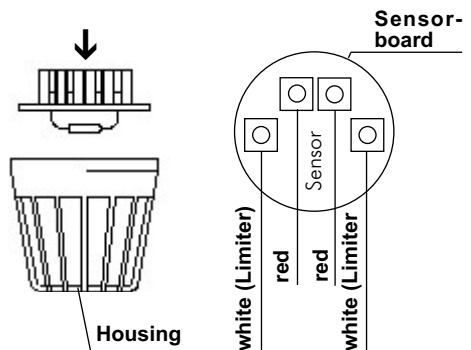

Illust. 11

Operation

Button Functions

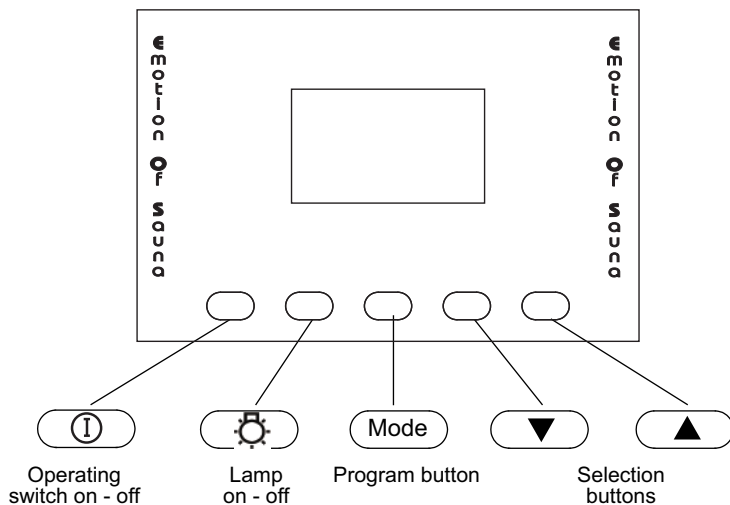

Symbol description



Time



Pre-selected time



Heating time

P3



Heating (dry)

P4



Ventilation function

Unit initialization

After checking all connections once more, connect the unit to the power supply by switching on the fuse and the main switch.

On the display appears

and the clock symbol begins to blink.

After a short time (30 seconds) you can start with programming.



You may now set the current time using the ▼ and ▲ buttons during the blinking of the clock symbol.



To accept the selected time, press the MODE-button until the selected time begins to blink.



Briefly **F1** appears on the display.

After that, the current time is displayed and the unit is ready for operation.

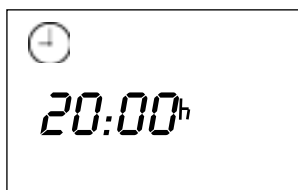

Turn on the unit by pressing the left **I** button. Simultaneously, this turns on the cabin lighting and the backlit display.

Finnish sauna operation

After switching on the unit, the display alternates between the time of day and the remaining heating time.

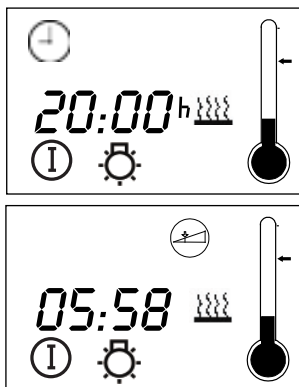

Temperature indicator

The temperature is displayed on the right-hand side of the display by a thermometer symbol.

An arrow on the right side of the thermometer displays the pre-selected temperature.

The colored area of the thermometer displays the current temperature in the cabin.

During the heating cycle the thermometer rises to the preset temperature. Once reached, the control phase begins.

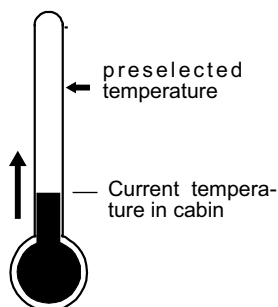

Default parameters

Heating time

By default the heating time is limited to 6 hours. After 6 hours, the unit will shut down for safety reasons.

The remaining heating time alternates with the current time of day on the display.

If you wish to end your sauna bath prematurely, press the **I** button.

The symbol on the display then disappears.

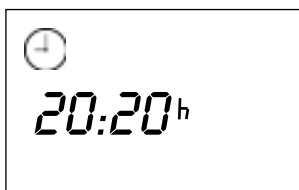

Important notes when programming

Every modification of the preset parameters must be confirmed by pressing the „MODE“ button.

If you do not press the „MODE“ button, the unit will automatically default back to the previous parameters.

If you do not touch the unit for a longer period of time during programming, the display will default back to standard and the illumination will cease after a short time.

Delayed startup

Using the time preset , you can set your sauna system to start up within 24 hours.



Always check for objects on the sauna oven before starting up the sauna. Fire hazard!

To select an alternate start-up time, press the „MODE“ button. The selection symbol **P1** appears on the display.

Press the „MODE“ button again and you see the actual start-up time.

Using the selection buttons ▼ and ▲ you can now set heating time.

Please consider, though, that the cabin needs 40-50 minutes for warming up, to create a pleasant climate in the cabin. For example, if you wish to take your sauna bath at 6 p.m., then you should set the startup time to 5:10 p.m.

Confirm the selected time by pressing the „MODE“ button. **P1** briefly appears on the display.

As long as P1 is shown on the display, press the  button to start the delayed start-up sequence.

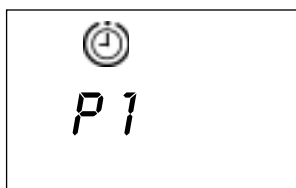
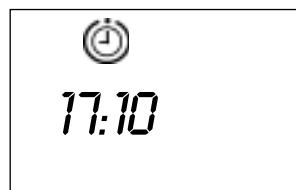
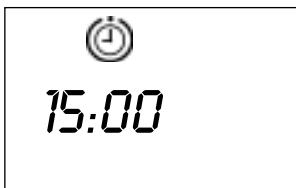
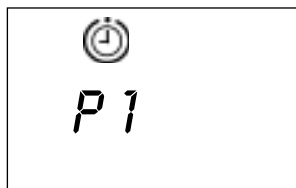

After a short time, the display alternates between current time and startup time. The display illumination goes out.

When the pre-selected start-up time is reached, the sauna switches itself on. After the designated heating time it then shuts itself back off automatically.

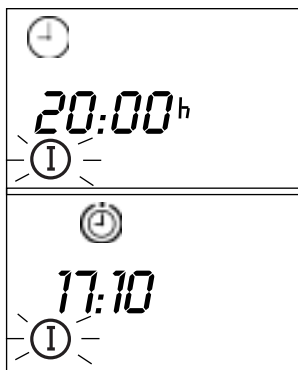

Heating time limiter

If you wish to individually set the heating time for your sauna system, press the „MODE“ button and choose **P2** using the selection buttons ▼ or ▲.

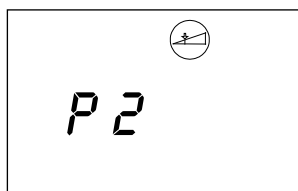

Press the „MODE“ button again.



Now you may set the heating time using the selection buttons.



Confirm your input by holding the „MODE“ button pressed continuously until the new heating time and the symbol expire on the display.

Afterwards **P2** shortly appears, then the display returns to default readout. The maximum heating time now matches the entered value until changed again (re-start required).

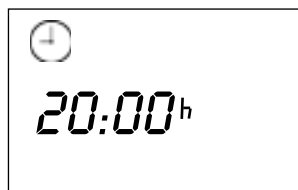

Changing the default temperature

By default the temperature for Finnish operation is set to 95°C. To change this parameter, press the „**MODE**“ button.

P1 then appears on the display in the programming area.

Press the ▲ button repeatedly until **P3** and the heating symbol appear on the display, and confirm this with the „**MODE**“ button.

The thermometer symbol appears, and the heating symbol begins to blink.

Use the selection buttons ▼ and ▲ to set the temperature. The arrow on the thermometer symbol displays the selected temperature level.

Finally, press and hold the „**MODE**“ button until the heating symbol besides the entered value begins to blink.

This confirms the entered value.

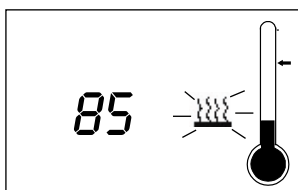
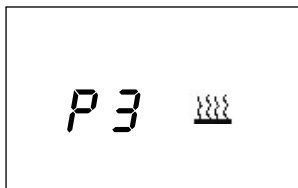
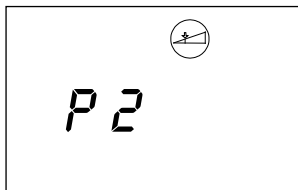

Programming fan operation

This control unit lets you operate a fan.

By factory default, „no fan operation“ is specified.

To program the fan function, first press the „**MODE**“ button to reach the programming mode.

Px then appears on the display.

Press the ▲ button repeatedly to reach the program level **P4**. The fan symbol appears on the display.

Confirm by pressing the „**MODE**“ button. A „0“ appears on the display (no fan operation).

By pressing the ▲ button, you can set a „1“ (fan operation).

Confirm your selection by pressing the „**MODE**“ button. On the display appears shortly **P4**, then the unit returns to its default readout and in set value „1“ the fan symbol appears on the display.

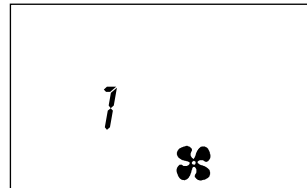
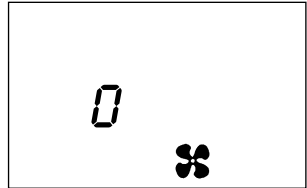
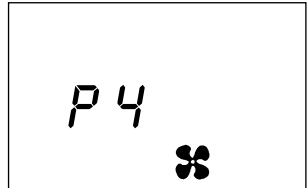
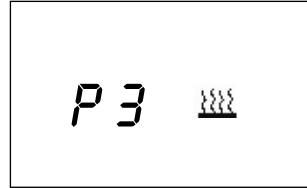

without symbol = no fan operation
with  symbol = fan operation

Programming current time

To reach this program level, press the „**MODE**“ button and the ▲ button simultaneously until **F1** is displayed, as well as the clock symbol.

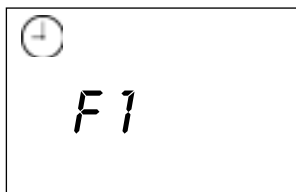

You can change the time with function **F1**. Confirm with the „**MODE**“ button and the previously set time begins to blink with the clock symbol.

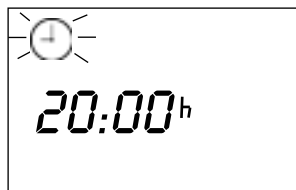

Set the current time using the ▲ and ▼ buttons (e.g. **when adjusting daylight-savings time**).



Confirm your selection by pressing and holding the „**MODE**“ button, until the entered value begins to blink.

F1 briefly appears on the display, then the unit returns to its default readout.

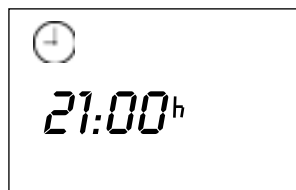

The control unit switch

The control unit switch can be found on the top end of the unit. Using this

switch, you can isolate the electronics from the mains supply in case of a breakdown. Please note that operating the control unit switch returns all settings to the factory settings.

In case of breakdown, press the control unit switch on the left part of the rocker to the first position (switch position 0). The unit is now completely switched off.

In order to switch on the light in the sauna when the unit is switched off, press on the left part of the rocker to the second position (switch position II).

In order to put the unit back into operation, switch back to the starting position (switch position I).

Control unit switch

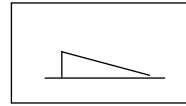

= unit switched on

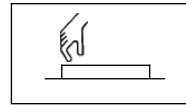

= unit switched off

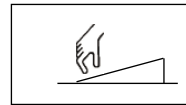

= light switched on

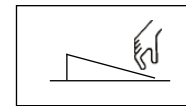

Error display

To quickly diagnose possible errors, use the error code explanation below to ascertain the type of error.

| Error code | Error |
|------------|--|
| E 100 | temperature sensor interruption/disconnection |
| E 101 | temperature sensor short circuit |
| E 211 | overheat safety shutoff interruption/disconnection |

The warning symbol  blinks whenever an error message is displayed, so you may easily recognize an error.

Additional errors not displayed and their causes:

Blank display - display not backlit

Check the power supply! All three phases L1, L2, L3 must be connected to 230 V AC.

Check all fuses.

Check the microfuse on the circuit board. You may use a 100 mA / T type fuse for replacement.

Wiring diagram

Attention!

Dear customer,

according to the valid regulations, the electrical connection of the sauna heater and the control box has to be carried out through the specialist of an authorized electric shop.

We would like to mention to the fact that in case of a warranty claim, you are kindly requested to present a copy of the invoice of the executive electric shop.

Sauna control unit

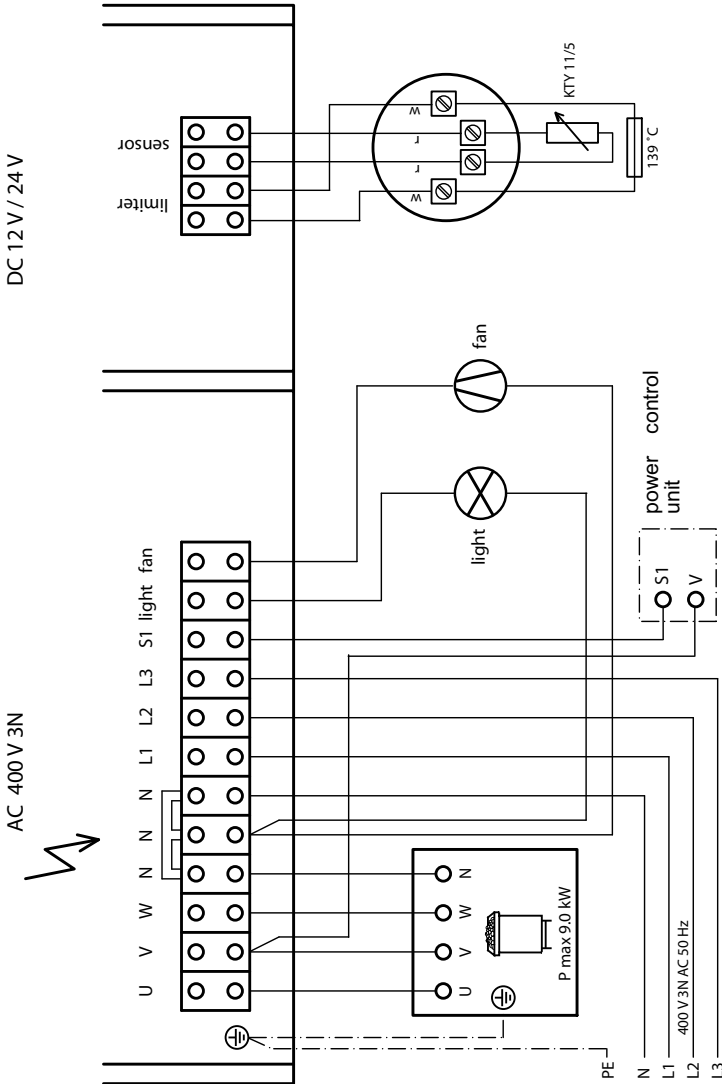

Please keep this address in a safe place together with the installation guide.

To help us answer your questions quickly and competently, please provide data printed on the ID plate, to include system type, article no. and serial no., in all inquiries.

Service Address:

EOS-WERKE GÜNTHER GmbH
Adolf-Weiß-Straße 43
35759 Driedorf-Mademühlen, Germany
Fon: +49 (0)2775 82-0
Fax: +49 (0)2775 82-431
servicecenter@eos-werke.de
www.eos-werke.de

Guarantee

The guarantee is taken over according to the legal regulations at present.

Manufacturer's warranty

- The period of warranty starts from the date of purchase and lasts up to 2 years for commercial use and 3 years for private use.

- Always include the completed warranty certificate when returning equipment.

- The warranty expires for appliances which have been modified without manufacturer's explicit agreement.

- Damages caused by incorrect operation or handling through non-authorized persons are not covered under the terms of warranty.

- In the event of a claim, please indicate the serial number as well as the article code number and type name with expressive description of the fault.

- This warranty covers damaged parts but no defects due to wear and tear.

In case of complaint please return the equipment in its original packaging or other suitable packaging (caution: danger of transport damage) to our service department.

Always include the completed warranty certificate when returning equipment.

Possible shipping costs arising from the transport to and from point of repair cannot be borne by us.

Outside of Germany please contact your specialist dealer in case of warranty claims. Direct warranty processing with our service department is in this case not possible.

Equipment start-up date:

Stamp and signature of the authorized electrician: