

emotion of sauna.



User's Guide

EMOTEC HCS 9003



GB

Made in Germany



IP x4

Druck Nr. 29343170en / -36.07

Table of Contents

Package contents	3
Technical data	3
General information concerning sauna bathing	4
General safety precautions	5
Assembly of the control unit	6
Wall mounting	6
Electrical connection	7
Connecting the sauna oven	7
Connecting the sauna lamp	7
Connecting the sensor lines	8
Mounting the oven sensor	8
Connecting the vaporizer	9
Fitting of the humidity sensor (optional)	9
Operation	10
Button functions	10
Symbol description	10
Switching on the device for the first time	11
Default parameters	12
Finnish sauna operation	12
Temperature indicator	12
Heating time	12
Please note the following when programming the unit	13
Specialist section	14
F1 Setting the current time	14
F2 Programming the reheating period after humid operation	15
F3 Programming the reheating temperature after humid operation	16
F4 Programming the reheating period after humid operation	17
F6 The optional humidity sensor	18
P1 Start with preset time	19
P2 Preset time mode	20
P3 Humid mode	21
Switching back to Finnish Operation	22
Switching during humidity operation	22
P4 Humidity setting	23
P5 Temperature setting	24
P6 Programming fan operation	25
P7 Ability to dim the cubicle lights	26
Coloured light (optional)	27
P9 Setting the time interval for the coloured light	29
The control unit switch	30
Changing the heating time limitation for commercial use	30
Error display	31
Other error options that are not displayed and their causes:	31
Connection diagram	32
Service Address:	33
Guarantee	33

Package contents

(subject to change)

Included with the control unit are:

1. An oven-sensor board with overheat shutoff protection, KTY-sensors with sensor housing , two 3x25 mm fastening screws and a 1,7 m long sensor cable, red and white.
2. A plastic bag with three 4 x 20 mm fastening screws.
3. A replacement overheat protection module.

Technical data

Nominal voltage:	400 V 3 N AC 50 Hz
Switching load:	max. 9 kW Ohm resistive load (AC1 - mode) Air conditioning mode: 6 kW + 3 kW for vaporiser device can be extended by connecting powered control units up to 36 kW
Heating time limit:	6 hr, 12 hr or no heating time limit
Display:	Jumbo backlit LCD
Protection class:	IPx4 in line with DIN 40050 splashed water resistant
Normal range for sauna:	30 to 110°C
Normal range for humid mode:	30 to 70°C
With humidity-control without humidity sensor:	me/proportional vaporizing control.
Sensor system:	KTY sensor with safety temperature limiter 142°C
Water level monitoring:	A lack of water in the vaporiser results in automatic shut down after two minutes Lack of water.
Control characteristic:	digital two-point regulation
Fan output:	min. 25W max.100 W max. 500 mA (only fan excluding capacitor)
Light:	min. 25W max.100 W max. 500 mA (only Ohm resistive load)



Fuse protection on the light and the ventilation can be a maximum of 0,5 A delay action. There is a danger of fire if greater fuse protection is used!

Coloured light (optional):	max. 100 W per colour
Colour on-time:	1 - 10 min
Colour order:	red - red/yellow - yellow - yellow/green - green - green/blue
-	blue - blue/red
Reheating:	0 - 20 min after switching off humidity program
Error display:	via warning triangle (flashing) and error code on LCD

Ambient temperatures:	-10°C to +40°C
Storage temperatures:	-20°C to +70°C

General information concerning sauna bathing

Dear customer,

with purchase of this sauna control unit you opted for a superior quality, high-tech electronic device which was developed and manufactured according to the highest standards and guidelines.

Please note that an optimal interaction of sauna cabin, sauna oven and sauna control unit is mandatory for a pleasant sauna climate in your cabin.

With this superior sauna control unit you can „operate“ your sauna system, and thanks to the many individual programming settings you will surely soon find the setting that suits you best.

Perception in the sauna is very subjective, therefore it really requires your own perception, or that of your family to find the most suitable settings.

By default the finnish sauna is preset to 95°C. For steam operation the values are set to 60°C and 60% humidity.

The following operation instructions describe how to pre-select „your“ climate in the cabin. Read these instructions carefully, so that you quickly and easily find your way through the programming process.

Please note the variation in temperatures in the cabin while sauna bathing. The hottest area is directly under the cabin ceiling, whereas there is a steady temperature gradient towards the floor of the cabin. Inversely, the relative humidity is lowest directly under the cabin ceiling and the highest on the cabin floor.

For safety reasons the temperature sensor with the overheat safety shutdown is located on the cabin ceiling above the oven, since this is the hottest area in the cabin.

Therefore there will always be temperature variations between the temperature sensor of the control unit and the thermometer in the cabin.

For the cabin light use only light bulbs. Do not use fluorescent lamps, energy saving lamps and gas discharge lamps.

For example, when pre-setting the cabin temperature to 100°C, the thermometer inside the cabin may easily show 85°C - 90°C. This complies with the typical climate inside the cabin.

Always observe hygiene. Always use hand- or bathing towels, to avoid getting perspiration on the wood.

To protect your cabin from possible damages due to steam operation, we recommend reheating or drying the cabin after every steam bath.



In addition, a fan can help to dissipate used humid air in badly ventilated areas.

To avoid the perception of draft, you should avoid using any ventilation system while sauna bathing. It should only be used if recommended by the cabin manufacturer



Always make sure no objects are located on the sauna oven before starting the heating cycle.

General safety precautions

- his device has not been designed for being used by persons (including children) that are physically or mentally handicapped or have sensory disabilities. Moreover, it is not allowed to use this device without sufficient experience and/or knowledge, unless these persons will be supervised by persons responsible for their security or in case they have been instructed how to use this device.
- Children are to be supervised in order to make sure that they do not play with this device.
-  Attention: It is forbidden to install the control box in a closed switch cabinet or behind a wooden panelling!
- The electrical installation may be done only by a qualified electrical technician.
- You must comply with the regulations of your power supply company and applicable VDE regulations (DIN VDE 0100).
-  WARNING: Never attempt repairs or installations yourself, as this could result in serious injury or death. Only a qualified technician may remove the housing cover.
- Please note the dimensions in the assembly instructions, especially when installing the temperature sensor. The temperature above the oven is critical for the temperature setting. The temperature can be held within operating parameters and a minimal temperature gradient inside the bench area of the sauna cabin can be achieved only if unit is assembled correctly.
- The device may only be used as intended as a control unit for sauna ovens up to 9 kW. (Up to 36 kW when combined with a breaking capacitor).
- Completely disconnect the control unit from the electrical circuit, i.e. flip all circuit breakers or the main circuit breaker during each installation or repair.
- Please note the safety and installation information from the sauna oven manufacturer.

Assembly of the control unit

Wall mounting

Mount the control unit outside the sauna cabin only. The most practical mounting point would be the wall area onto which the sauna oven is mounted on the inside, except on the outside of the cabin. If electrical conduits are present, mount the control unit accordingly. To mount the control unit, please follow these instructions:

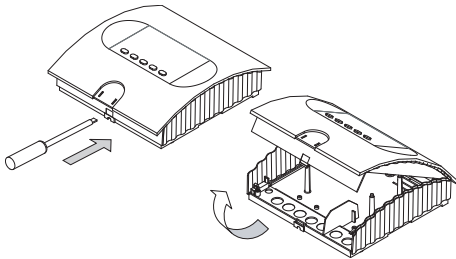

Illust. 1

1. Remove the cover of the control unit. To do this press the fastening tab inwards with a flat screwdriver and remove the housing top by pivoting it upwards (Illustr.1). Drill the threaded holes for the included 4 x 20 mm wood screws according to Illust. 3 & 3.1.
2. Insert one of the wood screws into the upper middle hole. This screw will be the mounting point for the control unit. Make sure the screw is projecting out from wall about 3 mm. (Illust. 3.2)
3. Hang the control unit onto the 3 mm projecting screw. Insert the included rubber sleeves into the openings on the back side of the housing and lead the electrical cable through these openings. Screw the lower part of the housing onto the cabin wall using the lower threaded holes. (Illust. 4)

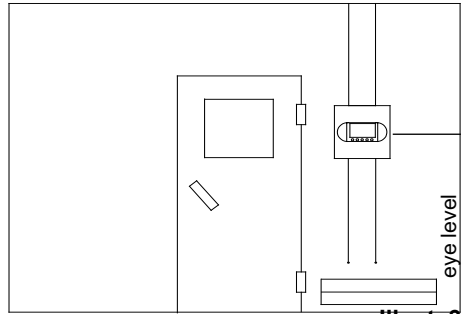

Illust. 3

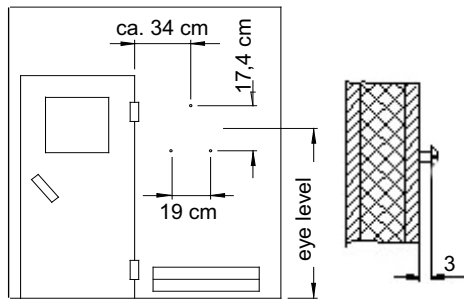

Illust. 3.1

Illust. 3.2

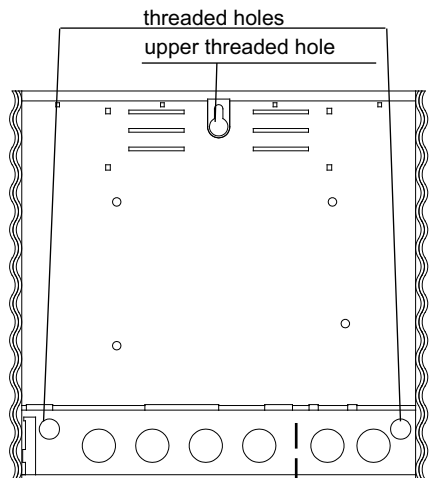

feed-through channel for
power supply lead wire
oven supply line
vaporizer supply line
lamp
fan

feed-through channel for
sensor lines

Illust. 4

Electrical connection



The electrical connection may only be done by a qualified electrical technician under authority of the regulations of the local power supply company and those of the VDE.

In general, there can only be one permanent connection to the power supply network, to include a device which allows the unit to be disconnected from the power source with a contact distance of at least 3 mm from all terminals.

All electrical installations and connector cables inside the cabin must be able to withstand temperatures up to 140°C. Please use the table below to determine the required cable diameters for this task.

Attach the power supply lead wire as shown in Illust. 5 to the power supply terminals of the control unit. Connection instructions are printed directly in the control unit.

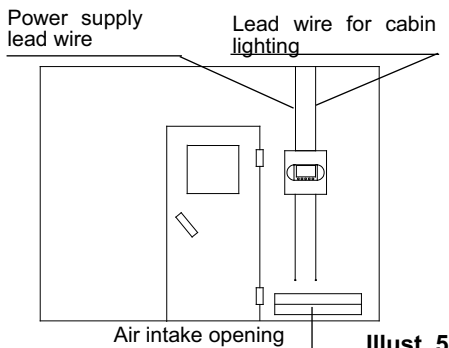

Illust. 5

Connecting the sauna oven

Assemble the sauna oven according to the instructions provided by the manufacturer in front of the air intake opening.

Lead the silicon lines through the electrical conduits to their respective terminals on the control unit and connect them according to the circuit diagram printed there.

Please note: If no electrical conduits are present, drill a hole with a diameter of 10 mm next to the air intake opening and lead the oven control cables through this hole to their corresponding terminals (U V W) in the control unit. To protect the silicon lines from external influences, install them in a shielded fashion. For this task, use a fitting cable or simple PVC conduit and lead the silicon cable through it to the control unit.

Connecting the sauna lamp

The sauna lamp must be splashproof (by Standard IPx4) and resistant to ambient temperature. The sauna lamp can be mounted anywhere except in the area of the rising hot air above the oven.

Connector capacity in kW	Appropriate for cabin sizes (in m ³)	minimum diameter in mm ² (copper wire) connection to 380 V 3N AC		
		Power supply lead wire to the control unit	Connector cable control unit for oven	safety fuse capacity in A
4,5	4 - 6	5 x 2,5 mm ²	5 x 1,5 mm ²	3 x 16
6,0	6 - 10	5 x 2,5 mm ²	5 x 1,5 mm ²	3 x 16
7,5	8 - 12	5 x 2,5 mm ²	5 x 1,5 mm ²	3 x 16
9,0	10 - 14	5 x 2,5 mm ²	5 x 1,5 mm ²	3 x 16

Connecting the sensor lines

You should not install sensor and power supply lines together, or lead them through the same conduit. This can lead to interferences in the electronics, such as „fluttering“ in the relays. If it is absolutely necessary to install them together, or the wire is longer than 3m, you should use a shielded sensor line such as the LIYLY-O x 0.5 mm²). Connect the shielding to mass in the control unit.

Please note that the following measurements are based on values provided by the unit quality assurance by the European Standard EN 60335-2-53. In principle, you must mount the oven sensor where temperatures are expected to be the highest. Illust. 7 gives you an overview of the mounting point of the sensor.

Mounting the oven sensor

1. Mount the oven sensor in cabins up to 2 x 2m according to Illust. 7 and 8, in larger cabins according to Illust. 7 and 9.

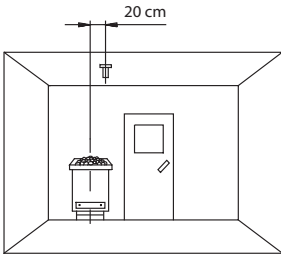

Illust. 7

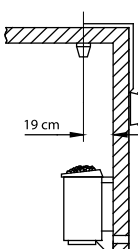

Illust. 8

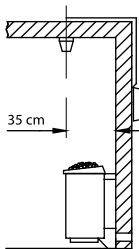

Illust. 9

2. Drill a hole to lead the cable through, preferably through the middle of one of the wooden boards.
3. Lead the sensor cable through the drilled hole and attach it to the sensor line according to Illust. 10.
4. Attach the lines for the shutoff (white) and the temperature sensor (red) according to Illust. 11 to the sensor board. Then insert the sensor board into the housing.
5. After you are finished installing and have made sure the control unit is functioning properly, check the line for overheat shutoff protection for short circuits. To do this, release one of the white lines in the sensor housing. The safety relay of the control unit should now fall; i.e. the heating circuit should now be interrupted.

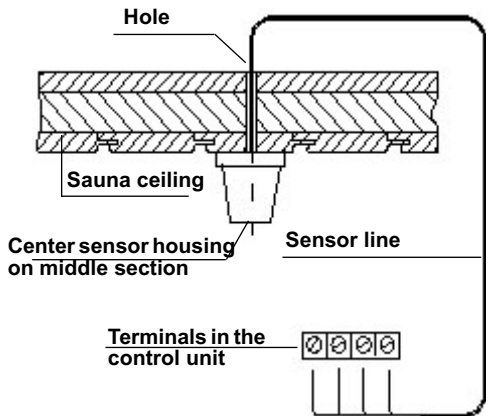

Illust. 10

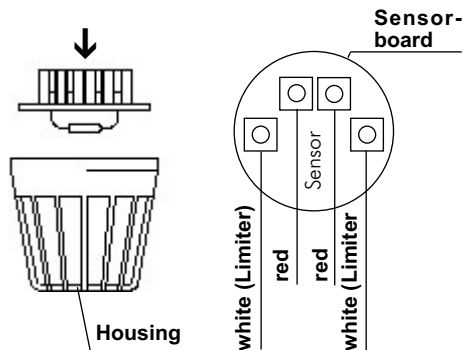

Illust. 11

Connecting the vaporizer

To connect the vaporizer, use silicon connecting lines 4 x 1,5 mm² as well.



Warning: When connecting the vaporizer make sure it is correctly attached to the water bath (WB) and low water shutoff (WM). If you switch these connections, you disable the water deficiency function and bypass the thermostat. As a result, the vaporizer will overheat.

This is a fire hazard!!

Illust. 6 shows the circuit diagram. The control unit can detect water deficit if there is a zero-potential feed at the WM-input.

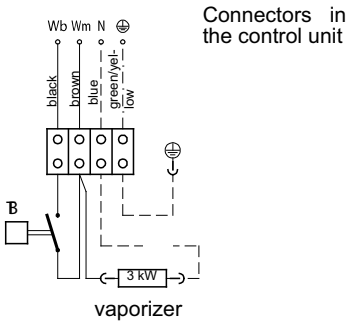

Illust. 6



Warning: Always connect the neutral conductor of the sauna oven. During steam operation, one phase of the oven is shut down; therefore the heating load is no longer symmetrical. The result is that the neutral wire is no longer current-free.

Fitting of the humidity sensor (optional)

1. The humidity sensor is fitted in the centre of the sidewall facing away from the oven at a height of approximately 150 cm.
2. See illust. 12 for the connection sequence of the strands.
3. Ensure the connection is exactly correct-incorrect connections can lead to defects in the sensor.

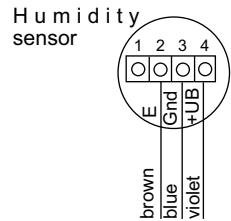

Illust. 12

The sensors are connected to the clamps at the lower right outer edge of the control unit in accordance with the following scheme.

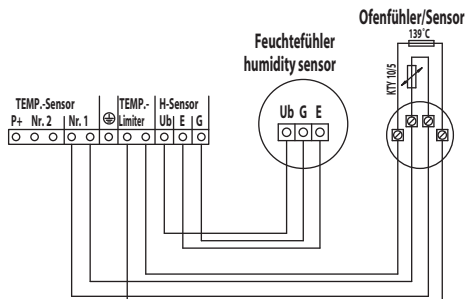

Operation

Button functions

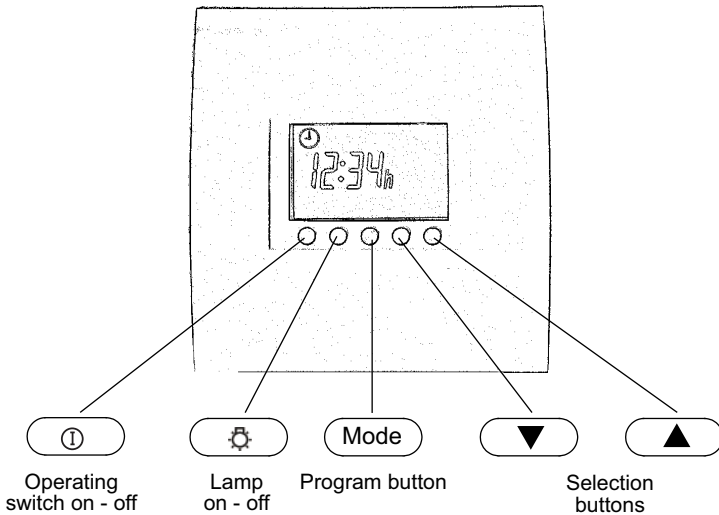

Symbol description

F1		Time	P5		Heating (dry)
P1		Pre-selected time	P5		Heating and steam (2 phases + vaporizer)
P2		Heating time	P6		Ventilation function
P3		Steam operation on/off	P7		Lamp
P4		Steam pre-selection	P9		Coloured light
					Error message

Switching on the device for the first time

After checking all the connections once again, connect the device to the mains by switching on the fuses or mains switch.

On the display appears the flashing notification.

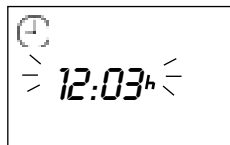

Please chose the wished value with the „▼“, and „▲“, Please chose the wished value with the



Please confirm with the „Mode“ button.



Afterwards the displays shows „F1“ for short time.

Afterwards the display shows the present time. The unit is ready to use.

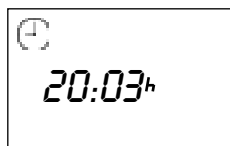

The device is switched on via the „I“, button. This also switches on the cubicle and screen lighting.

On the display appears



Default parameters

Finnish sauna operation

After switching on the screen displays the current time and remaining heating time alternately.



Temperature indicator

The temperature is indicated on the right side of the screen above the thermometer icon.

Here the pre-selected temperature is indicated by an arrow to the right of the thermometer.

The temperature in the cubicle is shown by the rising thermometer.

When heating the cubicle the thermometer fills up to the pre-selected temperature. Then the control phase starts.

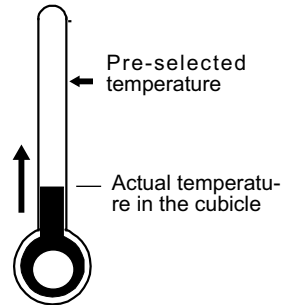

Heating time

the factory setting limits the heating time to 6 hours. This means that after switching on, the device switches off after 6 hours for safety reasons.

The remaining heating time is displayed on the screen alternately with the current time.

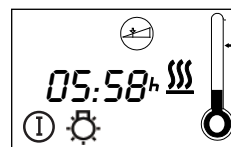
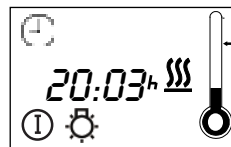

The sauna switches off automatically at the end of the selected heating time.

If you want to end your sauna before this time, press the „“ button. The sauna is switched off. The screen indicates the current time.



Please note the following when programming the unit

The buttons to be used are shown in the text as follows.

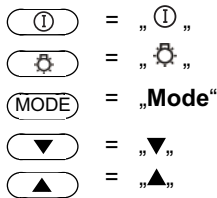

Symbols shown in the display sketches as follows will flash on the  display.

Every change to the set parameters must be confirmed and saved by pressing the „**Mode**“ button. The new values set flash briefly before the unit switches back to the basic display.

If you change the parameters without saving them with the „**Mode**“ button, the previous values automatically remain active.

If you do not operate the unit for a longer period when programming, the display switches back automatically to the basic display, and the background lighting switches off after a short time.

The many programming facilities of the unit are divided basically into:

Specialist levels

These levels are indicated by „**F 1 - F 6**“. Depending on the unit type, it may be that certain individual levels are not displayed.

Parameters that only have to be changed very rarely in daily use can be changed here. These are set following initial installation, and then usually remain unchanged, at least for an extended period.

Programmiererebenen

These levels are indicated by „**P 1 - P 9**“. Depending on the unit type or the set operating mode, it may be that certain individual levels are not displayed.

Parameters that are changed often to meet your individual requirements in daily use can be changed here.

Specialist section

F1 Setting the current time

For clock time adjustment please press „**Mode**“ and „**▲**“ button synchron.

(In the display appears „**F1**“ and the clock symbol.)

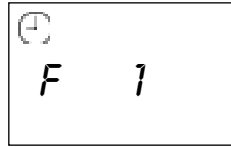

Please confirm with the „**Mode**“ button.



Please chose the wished value with the „**▼**“, and „**▲**“, buttons.

(to switch between **summer and winter time** for example)



Please confirm with a long press on the „**Mode**“ button until the new value is flashing on the display.

Afterwards the displays shows „**F1**“ for short time



F2 Programming the reheating period after humid operation

The heating time limiter is fixed at 6 hours.

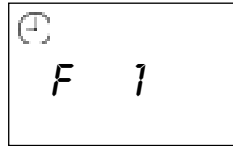

For pre heating time adjustment please press „**Mode**“ and „**▲**“ button synchron.

(In the display appears „**F1**“ and the clock symbol.) Afterwards press „**▲**“, button until „**F2**“ in the display appears.

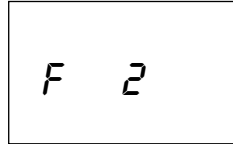

Please confirm with the „**Mode**“ button.

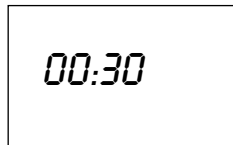

Please chose the wished value with the „**▼**“, and „**▲**“, Please chose the wished value with the



Please confirm with a long press on the „**Mode**“ button until the new value is flashing on the display.

Afterwards the displays shows „**F2**“ for short time. The post heating time is now fixed with the new value.

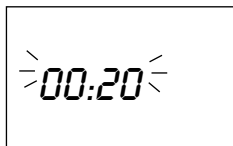

F3 Programming the reheating temperature after humid operation

The factory sets the reheating temperature to 95°C. This means that after humid operation the furnace heats up to 95°C during the pre-selected reheating time to dry the cubicle.

For post heating temperature adjustment please press „**Mode**“ and „**▲**“ button synchron.

(In the display appears „**F1**“ and the clock symbol.) Afterwards press „**▲**“, button until „**F3**“ in the display appears.

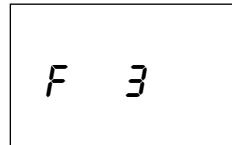
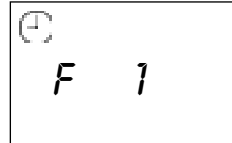

Please confirm with the „**Mode**“ button.



Please chose the wished value with the „**▼**“, and „**▲**“, buttons.



Please confirm with a long press on the „**Mode**“ button until the new value is flashing on the display.

Afterwards the displays shows „**F3**“ for short time. The post heating temperature is now fixed with the new value.



F4 Programming the reheating period after humid operation

By default the water-deficit safety shutoff is set to 2 minutes. This means, should your oven report a water-deficit, you have 2 minutes to refill it.

If the water-deficit warning runs for more than 2 minutes, the control unit shuts the entire sauna system off for safety reasons.

For switch off time adjustment please press „**Mode**“ and „**▲**“ button synchron.

(In the display appears „**F1**“ and the clock symbol.) Afterwards press „**▲**“, button until „**F4**“ in the display appears.

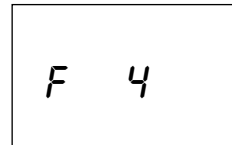
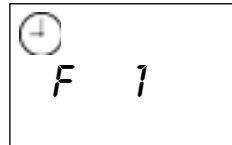

Please confirm with the „**Mode**“ button.

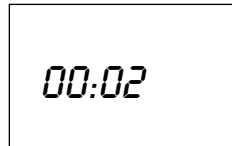

Please chose the wished value with the „**▼**“, and „**▲**“, buttons.

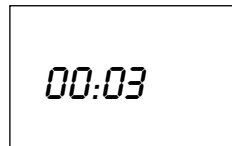

Please confirm with a long press on the „**Mode**“ button until the new value is flashing on the display.

Afterwards the displays shows „**F4**“ for short time. The switch off time is now fixed with the new value.

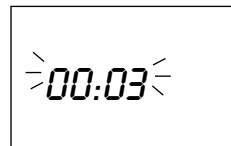

For safety reasons the maximally adjustable time is limited on 5 minutes.

F6 The optional humidity sensor

To activate or deactivate the F2 humidity sensor (after new installation or after error)

please press „**Mode**“ and „**▲**“ button synchron.

(In the display appears „**F1**“ and the clock symbol.) Afterwards press „**▲**“, button until „**F6**“ in the display appears.

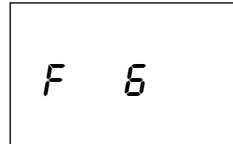
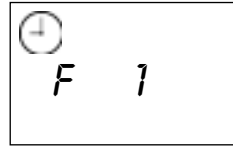

Please confirm with the „**Mode**“ button.

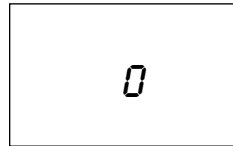

Please chose the wished value with the „**▼**“, and „**▲**“, buttons.

1: Humidity sensor activated

0: Humidity sensor deactivated



Please confirm with a long press on the „**Mode**“ button until the new value is flashing on the display.

Afterwards the displays shows „**F6**“ for short time. The figure is now fixed with the new value.

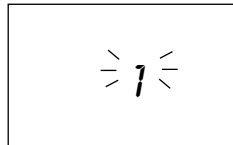

Programming section

P1 Start with preset time

You can use the time pre-selection to start your sauna within the next 24 hours.



Always ensure that no objects are located on the sauna heater at the start of heating process. Risk of fire!

For the heating adjustment please press „**Mode**“ button. In the display appears the pre heating time symbol and „**P1**“.



Please confirm with the „**Mode**“ button.

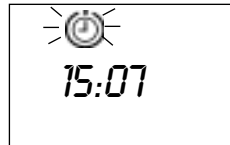

Please chose the wished value with the „**▼**“, and „**▲**“, buttons.

Please consider that the cubicle must heat up for around 40-50 minutes to achieve an appropriate temperature. If, for example, you want to start your sauna at 18.00 select the preset time to 17.10.



Please confirm with a long press on the „**Mode**“ button until the new value is flashing on the display.



The **P1** program function is displayed on the screen briefly.

While P1 is displayed on the screen press the  button until the preset time icon flashes. This starts the preset mode.

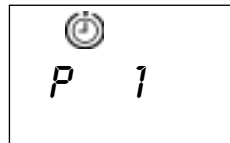

After a short time the screen displays the current time and preset heating time alternately. The screen's background lighting goes out.

When the preset time is reached the sauna equipment switches itself on. At the end of the heating period the control unit automatically switches the device off.

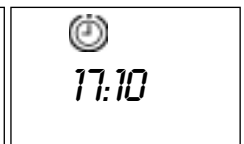
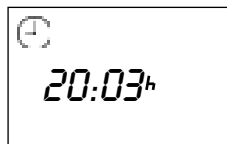

P2 Preset time mode

The heating time limiter is fixed at 6 hours. After these time the sauna will automatic shut-off.

For the heating time limiter adjustment please press „**Mode**“ button.

Afterwards the „▲“, button until in the display the the heating time symbol and „**P2**“ appears.

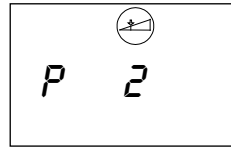

Please confirm with the „**Mode**“ button.



Please chose the wished value with the „▼“, and „▲“, buttons.



Please confirm with a long press on the „**Mode**“ button until the new value is flashing on the display.

Afterwards the displays shows „**P2**“ for short time. The heating time limiter is now fixed with the new value.



P3 Humid mode

For humidity operation adjustment please press „Mode“ button.

Afterwards the „▲“, button until in the display the humidity symbol and „P3“ appears.

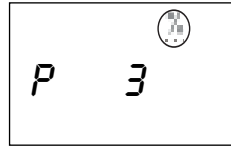

Please confirm with the „Mode“ button.

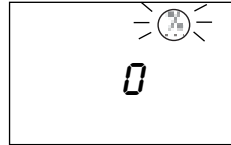

Please chose the wished value with the „▼“, and „▲“, buttons.

0 = Finnish operation

1 = Humidity operation

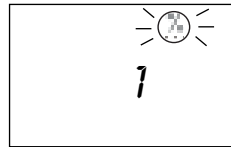

Please confirm with a long press on the „Mode“ button until the new value is flashing on the display.

Afterwards the displays shows „P3“ for short

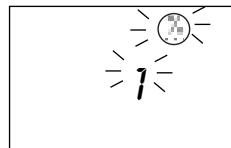

The default values are set to a temperature of 60°C and a humidity of 60%.

Press the „ⓘ“ button to start the steam operation mode.

If you programmed the unit while it was running, you must switch off and restart it using the „ⓘ“ button.



After starting up, the display alternates between the time of day, the remaining heating time and the preset humidity level.



The display indicates increasing cabin temperature through the rising thermometer, until it has reached the arrow representing the desired temperature.

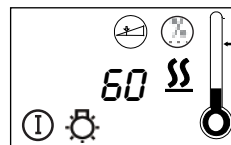

Once the heating cycle ends, the unit automatically starts the reheating program to dry out the cabin. The steam symbol disappears and the operation symbol ⓘ begins to blink.

The display now alternates between the time of day and the remaining reheating time. Once the reheating cycle is over, the control unit shuts down the system automatically.



Switching back to Finnish Operation

Press „MODE“ key.

Now press „▲“, key until P3 is shown on the display.

Confirm with „Mode“ key

The humidity operation can be deactivated with the „▼“, button.

Please confirm with a long press on the „Mode“ button until the new value is flashing on the display.

Afterwards the displays shows „P3“ for short time.

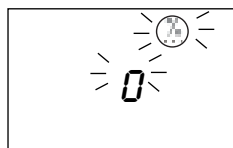
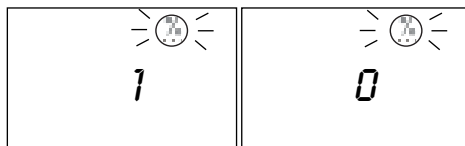
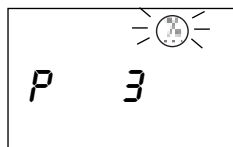

Switching during humidity operation

If you wish to switch to Finnish operation from steam operation, press the „▼“, and „▲“, buttons simultaneously. The unit now switches to Finnish operation with the preset temperature. The oven now heats in all three phases until the remaining heating time runs out, which can be seen by the ☁ symbol. Again, the display alternates with the time of day.

Once the heating time is over, the unit shuts down the sauna system automatically.

In the case of re-start the unit is started in humidity operation using the parameters last set.



Attention:

The temperature selection of these mode: only in the Finnish operation.

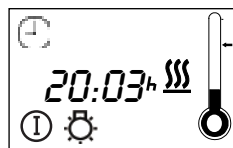

P4 Humidity setting

The humidity is set by the factory to a value of 60%

- if a humidity sensor is installed and activated the desired, relative air humidity is set in % (target value). When in operation the relative air humidity (actual value) around the humidity sensor is indicated.

- if no humidity sensor is installed or it is deactivated the value set – and displayed – indicates a time pulse value (e.g. 80% = vaporiser is switched on for 4 minutes and off for 1 minutes)

For humidity intensity adjustment please press „Mode“ button.

Afterwards the „▲“ button until in the display the humidity symbol and „P4“ appears.

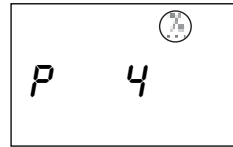

Please confirm with the „Mode“ button.

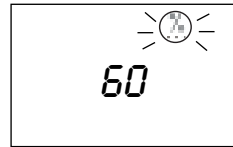

Please chose the wished value with the „▼“, and „▲“, buttons.

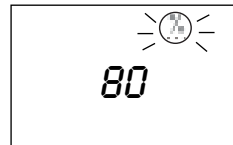

Please confirm with a long press on the „Mode“ button until the new value is flashing on the display.

Afterwards the displays shows „P4“ for short time. Humidity intensity is now fixed with the new value.

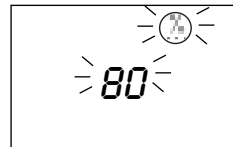

If you changed the setting during operation, the display now alternates between current time, remaining running time and the set humidity level.

P5 Temperature setting



Attention: Temperature range
in Finnish operation 30-110 C
in humidity operation 30-70 C

The temperature is fixed on 95C for Finnish operation and 60C for Humidity operation.

For temperature adjustment please press „**Mode**“ button.

Afterwards the „▲“, button until in the display the heating symbol and „**P5**“ appears.

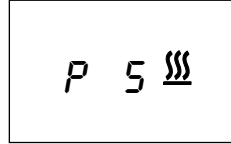

Please confirm with the „**Mode**“ button.

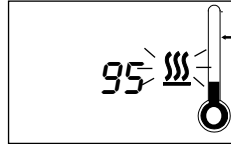

Please chose the wished value with the „▼“, and „▲“, buttons.

The arrow at the thermometer-symbol shows the selected temperature-area.

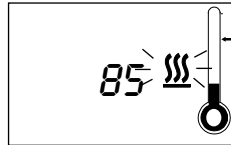

Please confirm with a long press on the „**Mode**“ button until the new value is flashing on the display.

Afterwards the displays shows „**P5**“ for short time. Temperature is now fixed with the new value.

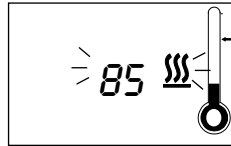

P6 Programming fan operation

This control unit gives you the option of switching on a fan (max. 100W) and setting the fan speed individually to one of 3 stages.

The default setting is „no fan mode“. Only in post heating operation after operation humidity the fan is default on the maximum step.

For fan function adjustment please press „**Mode**“ button.

Afterwards the „▲“, button until in the display the fan symbol and „P6“ appears.

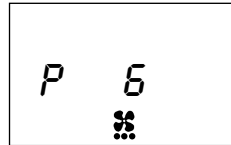

Please confirm with the „**Mode**“ button.

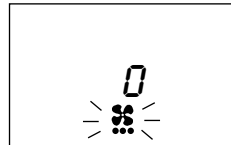

Please chose the wished value with the „▼“, and „▲“, buttons.

They mean:

0 = fan off

1 = fan level 1 (approx. 1/3 output)

2 = fan level 2 (approx. 2/3 output)

3 = maximum fan output

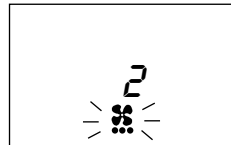

Please confirm with a long press on the „**Mode**“ button until the new value is flashing on the display.

Afterwards the displays shows „P6“ for short time. Fan function is now fixed with the new value.

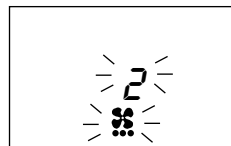

The selected level can be seen by the points under the fan icon on the screen.

Level 0 fan off

Level 1 

Level 2 

Level 3 

P7 Ability to dim the cubicle lights

Please note that this function may only be programmed in combination with incandescent bulbs. **No phosphorous, energy-saving or gas discharge bulbs may be used.**

The default light setting is maximum. You can dim the cubicle lighting of your sauna as you wish.

For illumination power adjustment please press „**Mode**“ button.

Afterwards the „...“ button until in the display the light symbol and „**P7**“ appears.



Please confirm with the „**Mode**“ button.

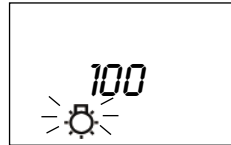

Please chose the wished value with the „▼“, and „▲“, buttons.

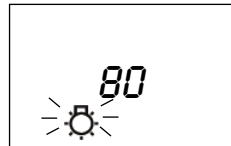

Please confirm with a long press on the „**Mode**“ button until the new value is flashing on the display.

Afterwards the displays shows „**P7**“ for short time. Illumination power is now fixed with the new value.

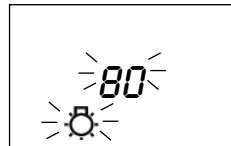

Coloured light (optional)



This programming option is only available if the coloured light module (item number 942761) has been installed.





Switch off all power to the system before installing the coloured light module.

You have the option of operating a coloured light device in your sauna using the HCS 9003 control unit. Each coloured light may not exceed the maximum power of 100 W.

Switching on the coloured light

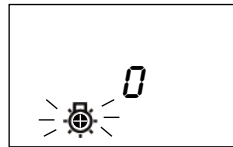
Press the „“ button for approx. 5 seconds. The coloured light symbol and the number 0 appear on the display.



Please choose the wished value with the „“, and „“ buttons.

They mean:

0 = off

1 = automatic mode

2 = permanent red

3 = permanent yellow

4 = permanent green

5 = permanent blue

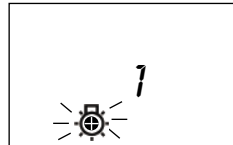

When the coloured light is switched on the screen also displays the flashing coloured light icon.



The coloured light icon indicates the segment for the colour that is currently lit.

The colours are assigned as follows.

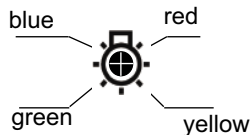

If coloured light mode is to be switched off use the previous instructions and set the value to „0“.

It goes without saying that the sauna lights can also be switched on and off in coloured light mode. To do so press the light switch as usual.

If the sauna light is on the coloured light icon does not flash but is shown constantly.

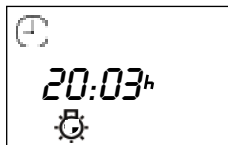

P9 Setting the time interval for the coloured light

This programming option gives you the option of automatically setting the length of time each colour is on. The default is one minute.

You can set on-time to between 1 and maximum 10 minutes..

For shining period adjustment please press „**Mode**“ button.

Afterwards the „▲“, button until in the display the colour light symbol and „**P9**“ appears.

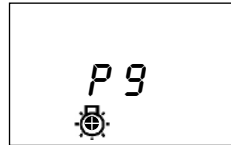

Please confirm with the „**Mode**“ button.

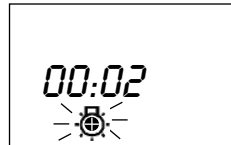

Please chose the wished value with the „▼“ and „▲“, buttons.



Please confirm with a long press on the „**Mode**“ button until the new value is flashing on the display.

Afterwards the displays shows „**P6**“ for short time. Shining period is now fixed with the new value.

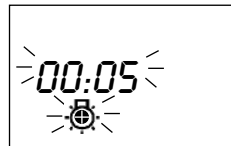

The control unit switch

The control unit switch can be found on the top end of the unit. Using this switch, you can isolate the electronics from the mains supply in case of a breakdown.

In case of breakdown, press the control unit switch on the left part of the rocker to the first position (switch position 0). The unit is now completely switched off.

In order to switch on the light in the sauna when the unit is switched off, press on the left part of the rocker to the second position (switch position II).

In order to put the unit back into operation, switch back to the starting position (switch position I).

Control unit switch

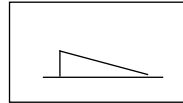

= unit switched on

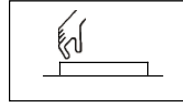

= unit switched off

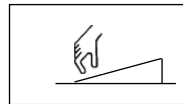

= light switched on

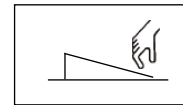

Changing the heating time limitation for commercial use

Attention! Completely disconnect the control unit from the electrical circuit!

As a standard, the control unit is supplied with a heating time limitation of 6 hours.

A jumper is present in the middle of the lower circuit board for conversion to 12 hours. It is inserted at the „6h“ mark at the factory. The heating time can be set to 12 or 24 hours by moving it to the „12h“ or „24h“ mark. If the jumper is removed completely the maximum heating time is 6 hours.

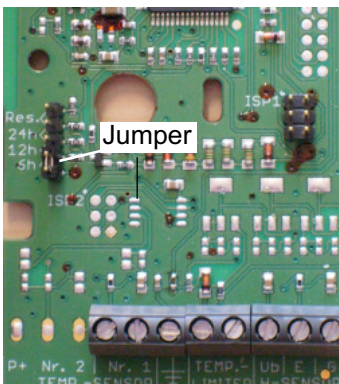

The maximum heating time private use is 6 hours. Resetting to 12 or more hours is permissible only for supervised (commercial) operation.

Error display

In order to provide an immediate diagnosis for any errors that may occur, the following errors can be determined via on-screen error codes.

Error code	Error
E 100	Temperature sensor paused
E 101	Temperature sensor short circuit
E 111	Humidity sensor paused
E 211	Excess temperature fuse paused
E 510	Lack of water – refill period
E 511	Lack of water – refill period exceeded

For each error code the  warning icon on the screen starts to flash so that it is easy to see that there is an error code.

To quit after notification of a lack of water (error message E511) press the Mode button and then restart the device.

Other error options that are not displayed and their causes:

KScreen is blank – no background lighting

Check the main switch setting.

Check the mains connection! Each of the 3 phases L1, L2 and L3 must have 230V AC.

Check the fuses!

Check the fine fuse on the circuit board. It is possible to replace it with a Type 100 mA / T fuse.

The temperature can not be set to over 70°C

Check whether the device is in Finnish mode. („P3=0“)

Connection diagram



Attention!

Dear customer,

according to the valid regulations, the electrical connection of the sauna heater and the control box has to be carried out through the specialist of an authorized electric shop

We would like to mention to the fact that in case of a warranty claim, you are kindly requested to present a copy of the invoice of the executive electric shop.

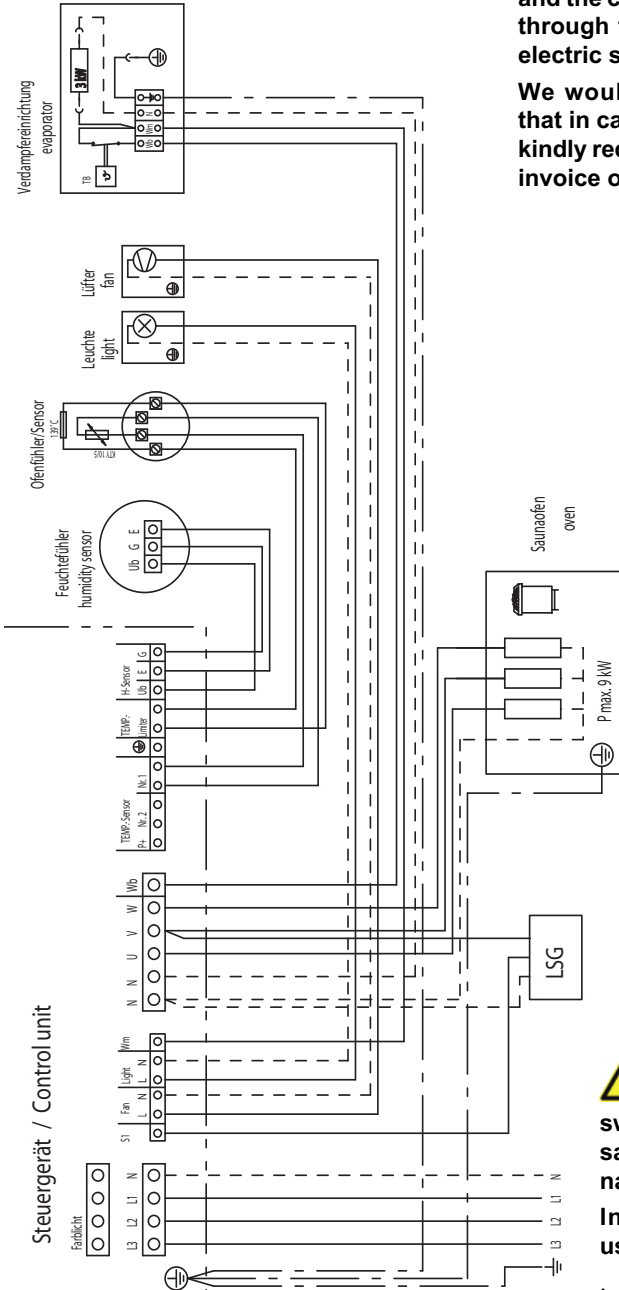

WARNING

When the vaporiser is switched on the „U“ output on the sauna heater on the „Wb“ terminal is switched to the vaporiser. In this case the sauna heater users 2/3 of the output.

Please keep this address in a safe place together with the installation guide.

To help us answer your questions quickly and competently, please provide data printed on the ID plate, to include system type, article no. and serial no., in all inquiries.

Service Address:

EOS-WERKE GÜNTHER GmbH
Adolf-Weiß-Straße 43
35759 Driedorf-Mademühlen, Germany
Fon: +49 (0)2775 82-0
Fax: +49 (0)2775 82-431
servicecenter@eos-werke.de
www.eos-werke.de

Guarantee

The guarantee is taken over according to the legal regulations at present.

Manufacturer's warranty

- The period of warranty starts from the date of purchase and lasts up to 2 years for commercial use and 3 years for private use.
- Always include the completed warranty certificate when returning equipment.
- The warranty expires for appliances which have been modified without manufacturer's explicit agreement.
- Damages caused by incorrect operation or handling through non-authorized persons are not covered under the terms of warranty.
- In the event of a claim, please indicate the serial number as well as the article code number and type name with expressive description of the fault.
- This warranty covers damaged parts but no defects due to wear and tear.

In case of complaint please return the equipment in its original packaging or other suitable packaging (caution: danger of transport damage) to our service department.

Always include the completed warranty certificate when returning equipment.

Possible shipping costs arising from the transport to and from point of repair cannot be borne by us.

Outside of Germany please contact your specialist dealer in case of warranty claims. Direct warranty processing with our service department is in this case not possible.

Equipment start-up date:

Stamp and signature of the authorized electrician: