

emotion of sauna.



User's Guide

EMOTEC HIC 75



GB

Made in Germany



Druck Nr. 29342614en/ - 20.08



English

Table of Contents

Package contents	4
Technical data	4
General information concerning sauna bathing	5
General safety precautions	6
Mounting	7
Mounting the output control appliance	7
Mounting the terminal	8
Wall mounting	8
Opening the appliance up for fastening to the wall	8
Electrical connection	10
Connecting the sauna oven	10
Wiring Diagram	10
Connecting the vaporizer	11
Wiring Diagram	11
Connecting the sauna lamp	11
Connecting the sensor lines	11
Mounting the oven sensor	12
Temperature indicator	14
Functional levels	16
Setting the current time	16
Programming the reheating period after humid operation	17
Programming the reheating temperature after humid operation	18
Programming switch off due to lack of water	19
Switching the sauna on	21
Switching the sauna off	22
Switching the sauna lights on/off	22
Program-levels	23
Start with preset time	23
Deactivating the preset time mode	24
Heating time limit	25
Humid mode	26
Humidity setting	27
Temperature setting	28
Programming fan mode	29
Ability to dim the cubicle lights	30
Switching over in IR mode	31
Programming coloured light (optional)	32

Setting the time interval for the coloured light	34
Error	35
Error display	35
Additional errors not displayed and their causes:	35
Connection diagram.....	36
Service Address:.....	38
Guarantee	38
Handling procedures for return shipments (RMA) - Details for all returns !	39

Package contents

(subject to change)

1. Output switch appliance
2. Control unit control appliance with connecting lead
3. An oven-sensor board with overheat shutoff protection, KTY-sensors with sensor housing, two 3x25 mm fastening screws and a 1,7 m long sensor cable, red and white.
4. A plastic bag with seven 4 x 20 mm fastening screws.
5. A replacement overheat protection module.

Technical data

Rated voltage:	230 V AC 50 Hz
Breaking capacity:	max. 3.3 kW ohmic load (power) temperature load (power): 2kW + 1kW for vaporizer appliance
IR mode:	max. 3.3 kW for 5 rays
Coloured light:	max. 4 x 100W
Heating time shut-off:	6 h
Display:	jumbo LCD, backlit
Protection type:	IPx4 in accordance with DIN 40050 (German Standards Institution), splashproofing
Control range sauna operation:	70 to 110°C
Control range, steam operation:	30 to 70°C
steam operation control:	time proportional vaporizer control 30 - 100%
Sensor system:	KTY-Sensor with overheat shutoff protection at 142° C
Water level control:	low water level in the vaporizer causes automatic shutoff after two minutes of low water level
Control characteristics:	digital two-step control
Ventilation capacity:	max. 100 W max. 500 mA (only fan without capacitor and no split-phase motors)
Light:	max. 100 W max. 500 mA (only ohm resistive load)



Fuse protection on the light and the ventilation can be a maximum of 500 mA delay action. There is a danger of fire if greater fuse protection is used!

Reheatingtime:	0 - 120 min. after shutoff of steam program
Error display:	blinking warning triangle and error code on LCD
Environmental temperature:	0°C to +40°C
Storage temperatures:	-20°C to +70°C

General information concerning sauna bathing

Dear customer,

with purchase of this sauna control unit you opted for a superior quality, high-tech electronic device which was developed and manufactured according to the highest standards and guidelines.

Please note that an optimal interaction of sauna cabin, sauna oven and sauna control unit is mandatory for a pleasant sauna climate in your cabin.

With this superior sauna control unit you can „operate“ your sauna system, and thanks to the many individual programming settings you will surely soon find the setting that suits you best.

Perception in the sauna is very subjective, therefore it really requires your own perception, or that of your family to find the most suitable settings.

By default the finnish sauna is preset to 95°C. For steam operation the values are set to 60°C and 60% humidity.

The following operation instructions describe how to pre-select „your“ climate in the cabin. Read these instructions carefully, so that you quickly and easily find your way through the programming process.

Please note the variation in temperatures in the cabin while sauna bathing. The hottest area is directly under the cabin ceiling, whereas there is a steady temperature gradient towards the floor of the cabin. Inversely, the relative humidity is lowest directly under the cabin ceiling and the highest on the cabin floor.

For safety reasons the temperature sensor with the overheat safety shutdown is located on the cabin ceiling above the oven, since this is the hottest area in the cabin.

Therefore there will always be temperature variations between the temperature sensor of the control unit and the thermometer in the cabin.

For the cabin light use only light bulbs. Do not use fluorescent lamps, energy saving lamps and gas discharge lamps.

For example, when pre-setting the cabin temperature to 100°C, the thermometer inside the cabin may easily show 85°C - 90°C. This complies with the typical climate inside the cabin.

Always observe hygiene. Always use hand- or bathing towels, to avoid getting perspiration on the wood.

To protect your cabin from possible damages due to steam operation, we recommend reheating or drying the cabin after every steam bath.



In addition, a fan can help to dissipate used humid air in badly ventilated areas.

To avoid the perception of draft, you should avoid using any ventilation system while sauna bathing. It should only be used if recommended by the cabin manufacturer



Always make sure no objects are located on the sauna oven before starting the heating cycle.

General safety precautions

- his device has not been designed for being used by persons (including children) that are physically or mentally handicapped or have sensory disabilities. Moreover, it is not allowed to use this device without sufficient experience and/or knowledge, unless these persons will be supervised by persons responsible for their security or in case they have been instructed how to use this device.
- Children are to be supervised in order to make sure that they do not play with this device.
-  Attention: It is forbidden to install the control box in a closed switch cabinet or behind a wooden panelling!
- The electrical installation may be done only by a qualified electrical technician.
- You must comply with the regulations of your power supply company and applicable VDE regulations (DIN VDE 0100).
-  WARNING: Never attempt repairs or installations yourself, as this could result in serious injury or death. Only a qualified technician may remove the housing cover.
- Please note the dimensions in the assembly instructions, especially when installing the temperature sensor. The temperature above the oven is critical for the temperature setting. The temperature can be held within operating parameters and a minimal temperature gradient inside the bench area of the sauna cabin can be achieved only if unit is assembled correctly.
- The device may only be used as intended as a control unit for sauna ovens up to 3,3 kW. (Up to 36 kW when combined with a breaking capacitor).
- Completely disconnect the control unit from the electrical circuit, i.e. flip all circuit breakers or the main circuit breaker during each installation or repair.
- Please note the safety and installation information from the sauna oven manufacturer.

Mounting

Mounting the output control appliance

The output control appliance should only be mounted outside the cabin. For the mounting spot, it is advisable to choose the exterior cabin wall or the cabin roof. If empty electrical conduits are present, these pre-determine the positioning of the output control appliance. For mounting the appliance, proceed using the following instructions.

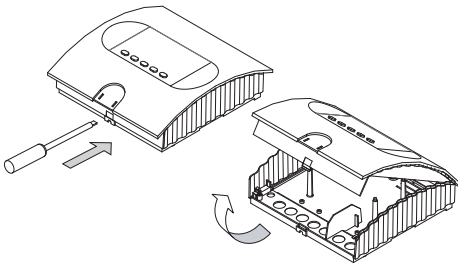

Illust. 1

1. Remove the cover of the control unit. To do this press the fastening tab inwards with a flat screwdriver and remove the housing top by pivoting it upwards (Illust.1).

The 5mm diameter drilled holes for the 4 x 20mm wood screws which are supplied are made corresponding to the measurements stated in Illust 2.

2. Insert one of the wood screws into the upper middle hole. This screw will be the mounting point for the control unit. Make sure the screw is projecting out from wall about 3 mm. (Illust. . 3).

3. Hang the control unit onto the 3 mm projecting screw. Insert the included rubber sleeves into the openings on the back side of the housing and lead the electrical cable through these openings. Screw the lower part of the housing onto the cabin

wall or ceiling using the lower threaded holes. (Illust. 4).

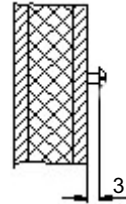
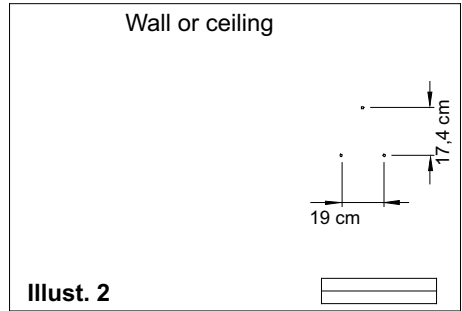

Illust. 3

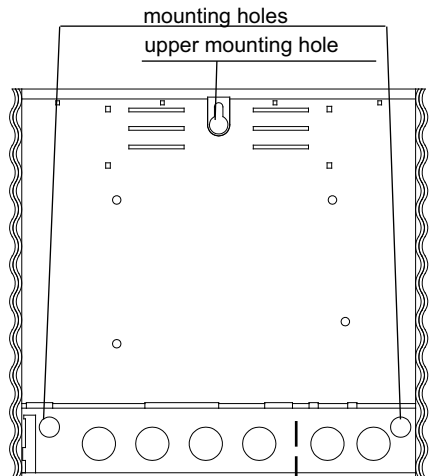

feed-through channel for power supply lead wireoven supply line vaporizersupplylinelampandan coloured light supply line

feed-through channels for the sensor supply line

Illust. 4

Mounting the Terminal

The output control appliance should only be mounted outside the cabin. For the mounting spot, it is advisable to choose the exterior cabin wall or the cabin roof. If empty electrical conduits are present, these pre-determine the positioning of the output control appliance. The mounting can be fitted onto or into the cabin wall. For mounting the appliance, use the following instructions.

Opening the appliance up for fastening to the wall

As an aid, put a screwdriver into the large slot in the clip recess (Fig 5).



Unlock the housing by lightly turning or tilting the screwdriver in the direction of the arrow (Fig 5) and swivel the upper part of the housing upwards.

Alternative method for opening the housing up by unlocking the front end

Please remove the cover of the control unit.

To remove the front cover please press the fastener with a small screwdriver and remove the cover by pivoting upwards. (fig 5a)



Subsequently, the upper part of the housing must be disengaged at the rear fixing flaps (see Fig 6).

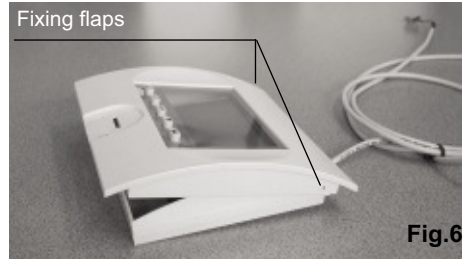

Wall mounting

1. Drill the threaded holes for the included 4 x 20 mm wood screws according to Illust. 7

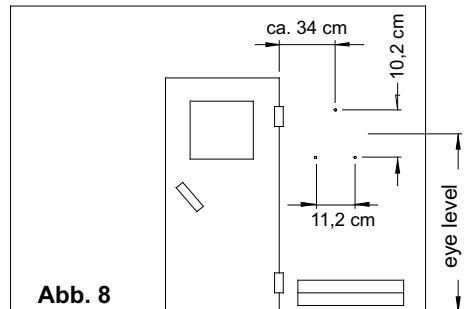
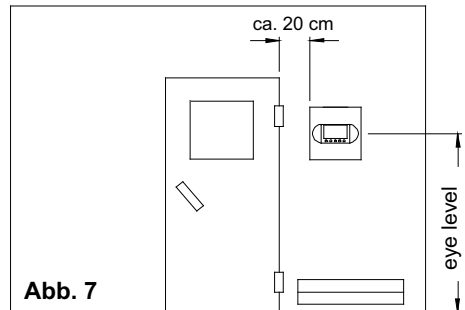

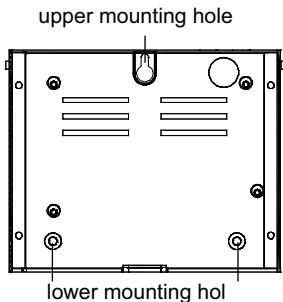

Fig. 9

2. Insert one of the wood screws into the upper middle hole (Illust.9). This screw will be the mounting point for the control unit. Make sure the screw is projecting out from wall about 3 mm. (fig. 10)

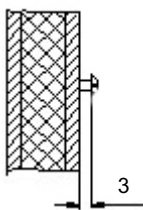

Fig. 10

3. Hang the control appliance on the 3mm screw which is projecting out of the upper mounting hole.

In both drilled holes underneath, screw the lower part of the housing into the cabin wall or cabin ceiling (fig 9)

Alternative method for mounting into the cabin wall (DL only)

The 4 drilled holes on the base are for mounting if the control appliance is to be fitted into the cabin wall (fig. 11 and 12)

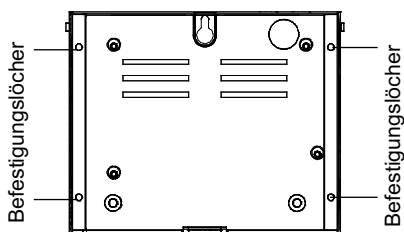

Fig. 11

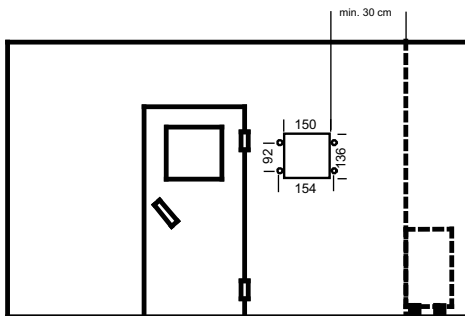

Fig. 12

Cable routing

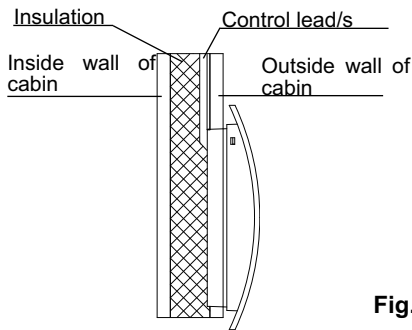

Fig. 12a

The control lead/s should only be laid between the insulation and the outside wall of the cabin (fig. 12a).

(The insulation must be provided in a way that a maximum of 75°C is reached on the outside.)

After mounting, insert the logo-clip into the recess on the upper part of the housing (fig 13).

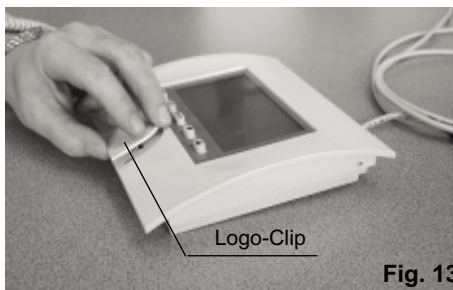

Fig. 13

Electrical connection

The electrical connection may only be done by a qualified electrical technician under authority of the regulations of the local power supply company and those of the VDE.

In general, there can only be one permanent connection to the power supply network, to include a device which allows the unit to be disconnected from the power source with a contact distance of at least 3 mm from all terminals.

All electrical installations and connector cables inside the cabin must be able to withstand temperatures up to 142°C.

The control cable from the control unit leads to the voltage control appliance and is plugged into the rear socket.

Connecting the sauna oven

Assemble the sauna oven according to the instructions provided by the manufacturer in front of the air intake opening.

Lead the silicon lines through the electrical conduits to their respective terminals on the control unit and connect them according to the circuit diagram printed there.

Please note: If no electrical conduits are present, drill a hole with a diameter of 10 mm next to the air intake opening and lead the oven control cables through this hole to their corresponding terminals (H1 H2 NG) in the control unit. To protect the silicon lines from external influences, install them in a shielded fashion. For this task, use a fitting cable or simple PVC conduit and lead the silicon cable through it to the control unit.

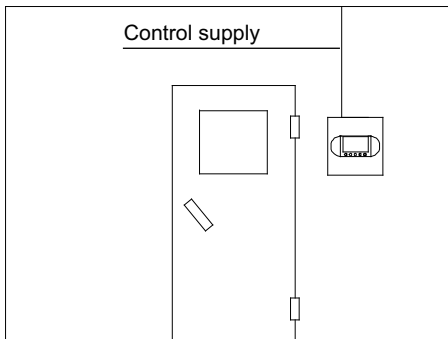

Illust. 14

The mains supply leads to the voltage control appliance and is connected to the mains input terminals.

Wiring Diagram

without vaporizer

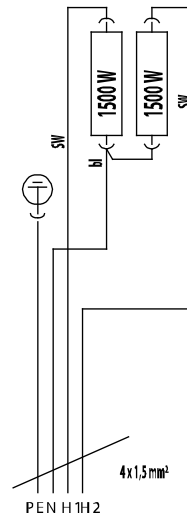

Illust. 15

Connecting the vaporizer

o connect the vaporizer, use silicon connecting lines 6 x 1,5 mm² as well.

Warning: When connecting the vaporizer make sure it is correctly attached to the water bath (WB) and low water shutoff (WM). If you switch these connections, you disable the water deficiency function and bypass the thermostat. As a result, the vaporizer will overheat.

This is a fire hazard!!

As H2 is not switched, cable 3 is not live in the vaporizer. It is operated only via H1 (oven heating element) and WB (vaporizer heating element). Please take care that the total output does not exceed 3.3 kW.

Connecting the sauna lamp

The sauna lamp must be splashproof (by Standard IPx4) and resistant to ambient temperature. The sauna lamp can be mounted anywhere except in the area of the rising hot air above the oven. **Only bulbs should be used!**

Wiring Diagram with vaporizer

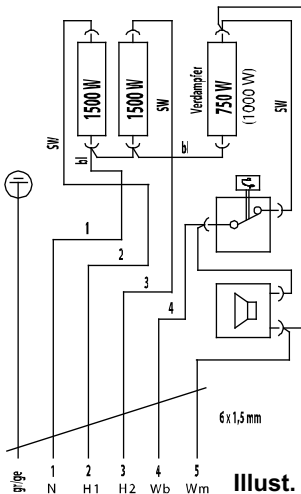

Illustr. 16

Connecting the sensor lines

You should not install sensor and power supply lines together, or lead them through the same conduit. This can lead to interferences in the electronics, such as „fluttering“ in the relays. If it is absolutely necessary to install them together, or the wire is longer than 3m, you should use a shielded sensor line such as the LIYLY-O x 0.5 mm²). Connect the shielding to mass in the control unit.

Please note that the following measurements are based on values provided by the unit quality assurance by the European Standard EN 60335-2-53. In principle, you must mount the oven sensor where temperatures are expected to be the highest. Illust. 7 gives you an overview of the mounting point of the sensor.

Mounting the oven sensor

1. Mount the oven sensor in cabins up to 2 x 2m according to Illust. 7 and 8, in larger cabins according to Illust. 7 and 9.

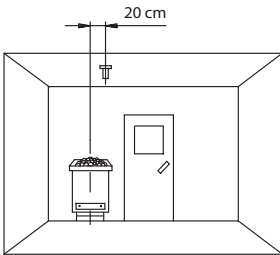

Illust. 7

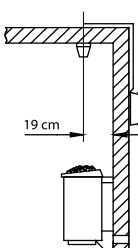

Illust. 8

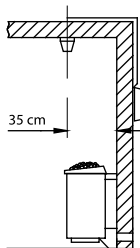

Illust. 9

2. Drill a hole to lead the cable through, preferably through the middle of one of the wooden boards.
3. Lead the sensor cable through the drilled hole and attach it to the sensor line according to Illust. 10.
4. Attach the lines for the shutoff (white) and the temperature sensor (red) according to Illust. 11 to the sensor board. Then insert the sensor board into the housing.
5. After you are finished installing and have made sure the control unit is functioning properly, check the line for overheat shutoff protection for short circuits. To do this, release one of the white lines in the sensor housing. The safety relay of the control unit should now fall; i.e. the heating circuit should now be interrupted.

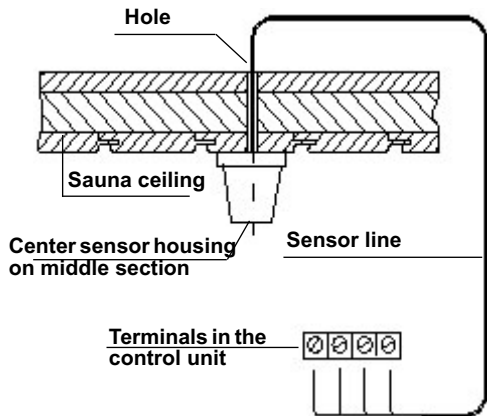

Illust. 10

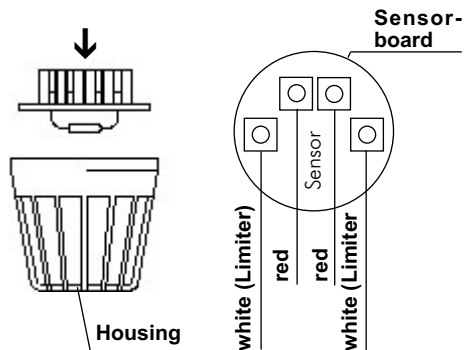

Illust. 11

Operation

Button functions

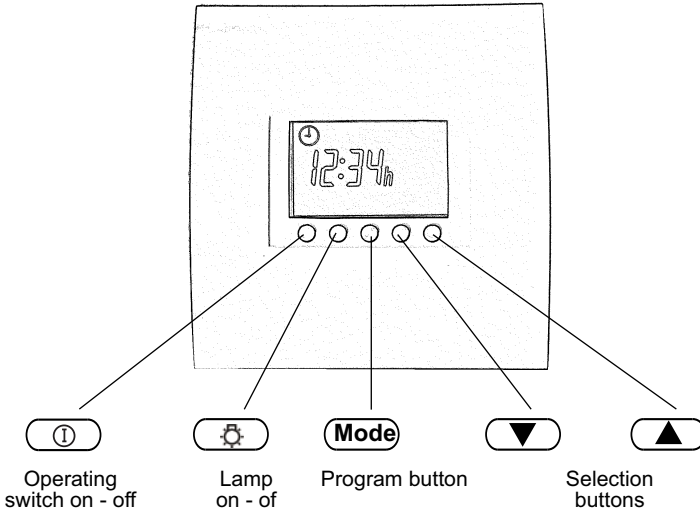

Illust. 22

Symbol description



Time



IR - Mode



Preset time



Light



Heating time



Coloured light (optional)



Humidity mode



Fan functions



Heating (Finnish)



Error message



Heating with humidity

Temperature indicator

The temperature is indicated on the right side of the screen above the thermometer icon.

Here the pre-selected temperature is indicated by an arrow to the right of the thermometer.

The temperature in the cubicle is shown by the rising thermometer.

When heating the cubicle the thermometer fills up to the pre-selected temperature. Then the control phase starts.

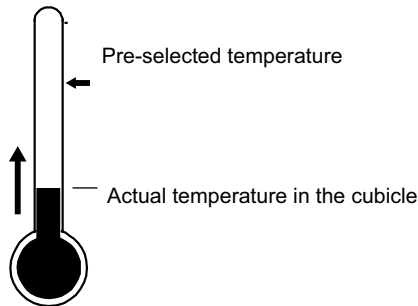

Switching on the device for the first time

After checking all the connections once again, connect the device to the mains by switching on the fuses or mains switch.

This also switches on the screen lighting.

The screen displays

... and the time icon starts to flash.

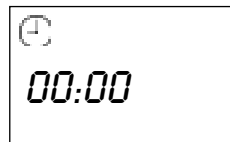

Use the ▼ and ▲ buttons to set the current time

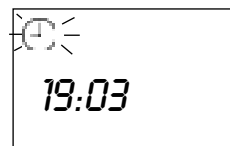

To adopt the time press the „**Mode**“ button.



For a short time „**F1**“ is displayed on the screen.

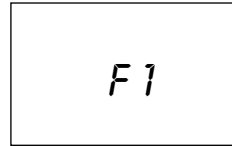

Then the screen displays the current time and the device is operational.

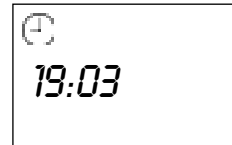

On the following pages, you will be shown the many settings available with the EMOTEC HIC 75.

A difference is made between 2 categories:

- Firstly parameters that you usually only set once and then never or only rarely change. These parameters are programmed in the „**F...**“ function level. The next section of the operating instructions lists the settings for these parameters.
- Other parameters that you frequently change to your current needs when using the sauna. You change these parameters in the „**P...**“ programming level.

Functional levels

Setting the current time

(e.g. summer – winter time)

First press the „**Mode**“ and ▲ buttons at the same time to enter the functional level. The display shows „F...“.

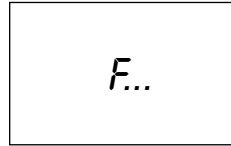

Now select „F1“ using the ▼ or ▲ button.

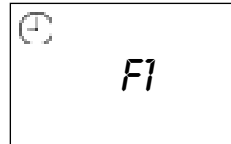

Confirm the entry with the „**Mode**“ key. The current time is displayed and the clock icon flashes.

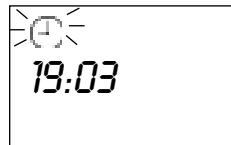

Use the ▼ and ▲ buttons to change the value.



Then you have to confirm the new value. To do so press the „**Mode**“ button until the value starts to flash.

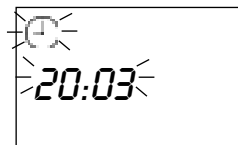

The new value has now been adopted and the normal time appears in the display.

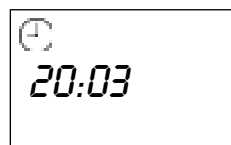

Programming the reheating period after humid operation

In order to dry your cabin out after it has been used in the humid mode, a residual heating period is switched on after switching off. The default factory setting for reheating is 30 minutes..

If you want to change this reheating period press „Mode“ and ▲ at the same time.



Now select „F2“ using the ▼ or ▲ button.

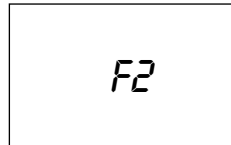

After you have confirmed the entry with „Mode“ - key.

The last reheating time setting is displayed on the screen.



You can set the desired time using the ▼ or ▲ button.

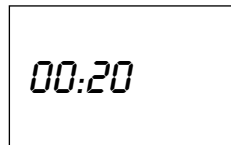

Confirm the entry with the „Mode“ key.

The current reheating time setting is displayed on the screen.

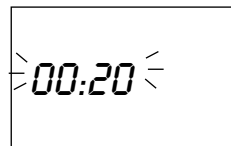

The new value is adopted and the appliance goes back to the standard display.

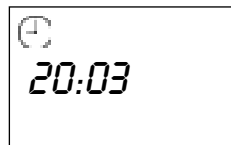

Programming the reheating temperature after humid operation

The factory sets the reheating temperature to 95°C. This means that after humid operation the furnace heats up to 95°C during the pre-selected reheating time to dry the cubicle.

To change the reheating temperature first press „**Mode**“ and ▲ at the same time to enter the programming mode.

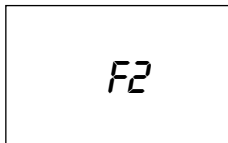

Subsequently, using the ▼ or ▲ button, select the functional level „**F3**“.

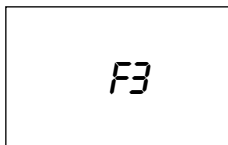

Confirm by pressing the „**Mode**“ button and the screen indicates the most recently selected temperature.



Use the ▼ and ▲ buttons to individually change the reheating temperature for your sauna equipment.



Confirm your entry by pressing the „**Mode**“ button for a long time until the value set on the display flashes.



The new value is adopted and the appliance goes back to the standard display.

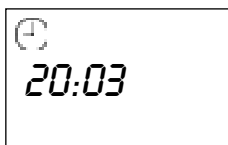

Programming switch off due to lack of water

The safety switch due to lack of water is set by the factory to 2 minutes. This means that if your furnace detects a lack of water you have 2 minutes to refill it. The error message opposite appears in the display.

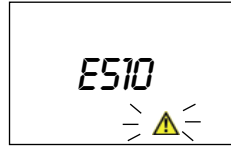

If no water is filled within the set time, the appliance switches the entire sauna off for safety reasons. The error message opposite appears in the display.

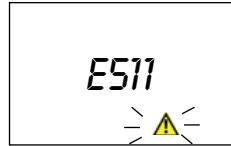

To cancel the safety switch due to lack of water, first press the „**Mode**“ button and switch the appliance off using the ⓘ button.

To change this time setting, press the „**Mode**“ and ▲ buttons at the same time and you will arrive at the function mode.

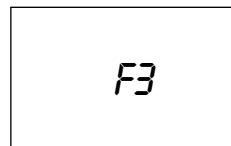

Select the **F4** functional level by pressing the ▲ or ▼ button repeatedly.

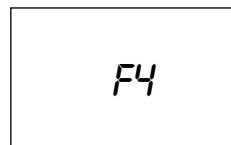

After you have confirmed the entry with „**Mode**“ the set time finally appears.

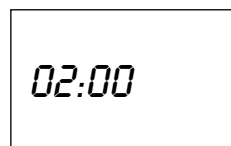

You can set the desired time using the ▲
or ▼ button.

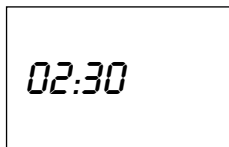

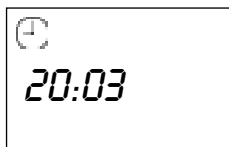
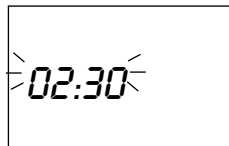

After confirming the entry by pressing the „**Mode**“ button until the new value flashes, the appliance goes back to its normal state. As a result, the new value is adopted.



The values set up to this point are not usually or ever changed during operation. The following pages show you how to adapt your sauna to your individual needs.

Switching the sauna on



The device is switched on via the  button. This also switches on the cubicle

As your control device is in **Finnish mode** (level „P3=0“) the sauna furnace and lighting are now switched on. The  and  icons are displayed on the screen. The current time and remaining heating time are shown alternately. The thermometer indicates the actual and target temperatures.

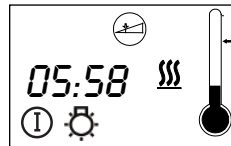
If the sauna furnace is actually heating the  icon is also visible.



If the device is in humid mode (level „P3=1“) the sauna furnace, vaporiser and sauna lights are operating.

The screen displays the  and  icons and alternately the current time,

the humidity value

- as the current value if a humidity sensor is installed and active

- as a percentage of the time pulse if no humidity sensor is installed or it is deactivated

and the remaining heating time.

The thermometer indicates the actual and target temperatures.

If the sauna furnace is actually heating the  icon is also visible..

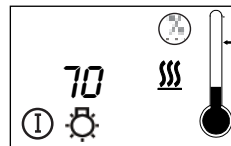
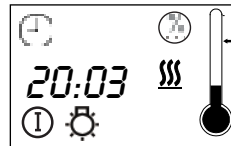

Switching the sauna off

In the Finnish and/or IR mode, your sauna control appliance automatically switches the sauna furnace and/or the IR radiator off after the heating up period has come to an end. If you want to finish your sauna session early, press the  button. The sauna will then switch itself off.

In the humid mode residual heating is switched on. If the residual heating has likewise come to an end, the appliance switches the sauna furnace off. By alternately showing the display opposite, the appliance displays that the residual heating is completed. By actuating the  button, the appliance can now be reset to its normal state.

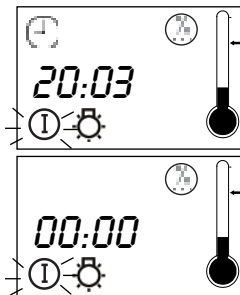

Switching the sauna lights on/off

Press the  button to switch the sauna lights on or off.

Program-levels

Start with preset time

You can use the time pre-selection to start your sauna within the next 24 hours.



Always ensure that no objects are located on the sauna heater at the start of the heating process. Risk of fire!

For programming the preset time, change to the programming mode by pressing the „**Mode**“ button.

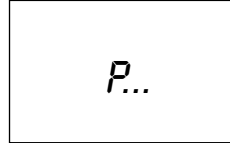

Using the ▲ or ▼ button, change to the „**P1**“ level. In the display, you will see the preset time symbol and „**P1**“.

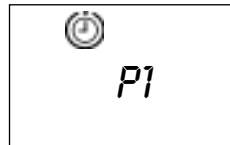

After you have confirmed the entry using the „**Mode**“ button, the preset time which was last set and the preset time symbol appear in the display.

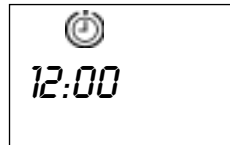

Press the ▼ or ▲ buttons to preset a heating period.

Please consider that the cubicle must heat up for around 40-50 minutes to achieve an appropriate temperature. If, for example, you want to start your sauna at 18.00 select the preset time to 17.10.

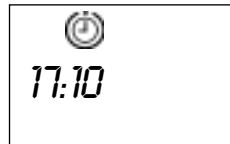

You can adopt the new value by pressing the „**Mode**“ button until the preset time symbol flashes and the control resets itself to the normal state display.

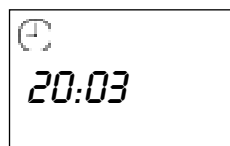
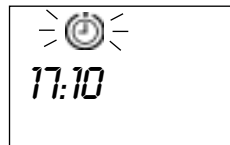

To activate the preset time, repress the „Mode“ button in the „P1“ level.

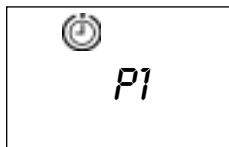

Now actuate the ① button. The preset time symbol will start to flash.

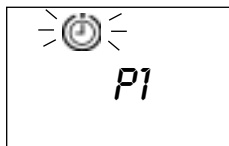

The preset time is now activated and the sauna will be switched on at the set point in time. In the display, the current time and the preset time are displayed alternately. Additionally the ① symbol flashes.

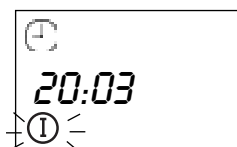

Deactivating the preset time mode

Actuate the ① button for a short time and the preset time is deactivated. The appliance resets itself to its normal state.

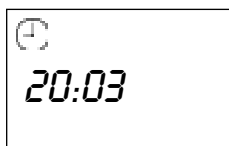

Heating time limit

At the factory, the sauna was set to run with limited heating period of 6 hours. For safety reasons, the sauna furnace appliance switches the entire sauna off after this period.

If you would like to set the heating time individually for your sauna first press the „**Mode**“ button.

The screen display the following message.

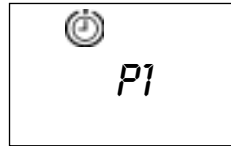

Using the ▼ or ▲ button, select the „**P2**“ level.

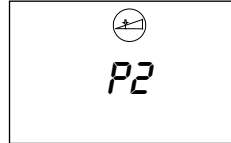

Confirm the entry by pressing the „**Mode**“ button. The heating period symbol appears in the display and the heating period which was last set.



Now you can preset the heating time as required using the ▼ and ▲ setting buttons.

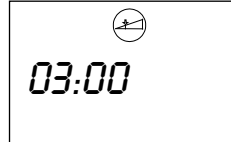

You can subsequently adopt the newly set value by pressing the „**Mode**“ button until the heating period symbol flashes. The newly set value is now active and the appliance goes back to its normal state.

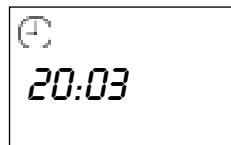
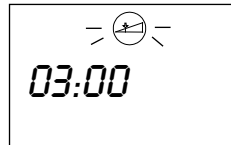

Humid mode



Warning: If the IR mode is activated (P8 = 0), the appliance cannot operate in the humid mode.

If the device should operate in humid mode this must first be activated. To do so press the „**Mode**“ button.

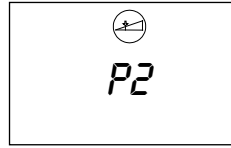

Using the ▲ or ▼ button, now select the „**P3**“ level.



Confirm the entry by pressing the „**Mode**“ button. The humid symbol appears in the display and a „**0**“ = Finnish mode.

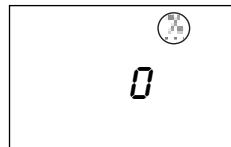

Confirm using the ▲ button and a „**1**“ is displayed on the screen.

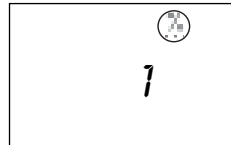

After you have pressed the „**Mode**“ button until the humid symbol flashes, the appliance goes back to its normal state.

When it is switched on, the appliance now starts in the humid mode.

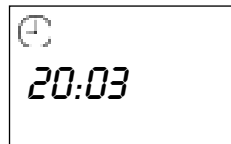
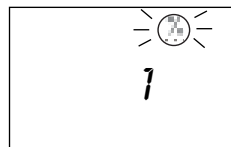

Return to Finnish operation

Use the process described above, only this time a „**1**“ is displayed at first (humid mode). Change this to a „**0**“ (Finnish mode) by pressing the ▼ button.

Humidity setting

At the factory, the sauna was set to run with a humidity of 60%. Bear in mind however that this does not relate to the relative humidity in the cabin but a time interval value (e.g. 80% = a vaporizer period of 4 mins on, 1 min off).

To adjust this value to your desired setting, press the „**Mode**“ button in order to arrive at the function mode.

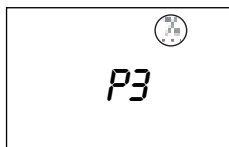

Now, using the ▼ or ▲ button, select the „**P4**“ level.

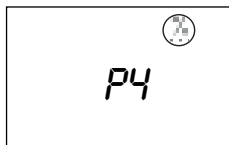

After you have confirmed the entry by pressing the „**Mode**“ button, the humid symbol appears in the display and the humidity value which was last set.

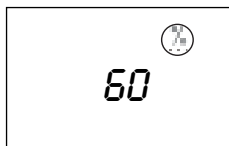

Use the ▼ and ▲ buttons to set desired value.



Confirm the new value by actuating the „**Mode**“ button until the humid symbol starts to flash. The value is now adopted and the appliance goes back to its normal state.

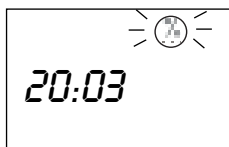

Temperature setting



There is a different setting range for humid and Finnish modes.

-in humid mode the regulation range can be set between 30°C and 70°C. The default setting is 60°C.

-in Finnish mode the regulation range can be set between 40°C and 110°C. The default setting is 95°C.

-in IR mode, the range which can be set lies between 30 ° C and 80 ° C. Here, 40 ° C has been preset at the factory.

To set this value individually, first press the „**Mode**“ button in order to arrive at the programming mode.

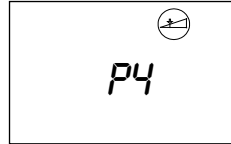

By means of the ▼ or ▲ button, change to the „**P5**“ level.

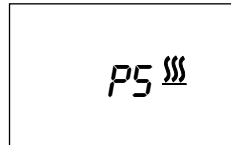

After you have confirmed this value with the „**Mode**“ button, the heating symbol appears and the heating value which was last set.

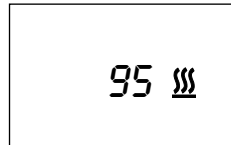

Use the ▼ and ▲ buttons to change the value.

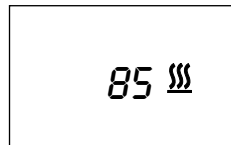

The value is adopted by actuating the „**Mode**“ button until the heating symbol starts to flash. Subsequently the appliance goes back to its normal state.

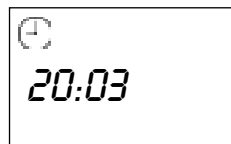
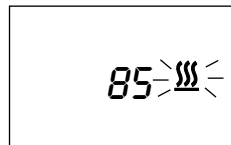

Programming fan mode

This control unit gives you the option of switching on a fan (max. 100W) and setting the fan speed individually to one of 3 stages.

A „no fan mode“ is preset at the factory.

To program the fan function first press „**Mode**“ to enter the programming mode.

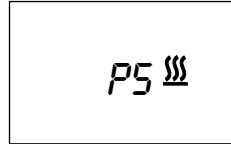

You progress to the „**P6**“ programming level by pressing the ▼ or ▲ button.

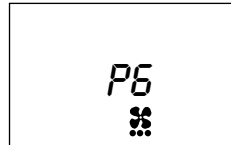

Confirm the entry by pressing the „**Mode**“ button. In the display you will see the fan symbol and the setting which was last entered.

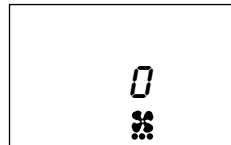

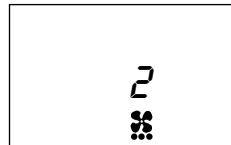

You can then select the switching levels using the ▼ and ▲ buttons.



They mean:

Level 0 fan off

Level 1 approx. 1/3 fan output 

Level 2 approx. 2/3 fan output 

Level 3 maximum fan output 

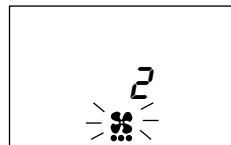

You can subsequently adopt the new value by pressing the „**Mode**“ button until the fan period symbol flashes. Then, the appliance goes back to its normal state by itself.

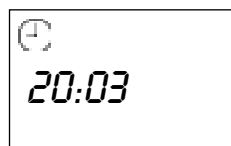

Ability to dim the cubicle lights

Please note that this function may only be programmed in combination with incandescent bulbs. **No phosphorous, energy-saving or gas discharge bulbs may be used.**

The default light setting is maximum. You can dim the cubicle lighting of your sauna as you wish.

To do so press the „**Mode**“ button to enter the programming mode.

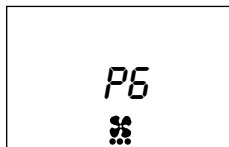

Now, using the ▼ or ▲ button, select the „**P7**“ programming level.

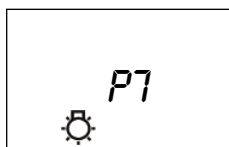

After you have confirmed the entry with the „**Mode**“ button, you will see the light bulb symbol in the display and the value which was last entered.

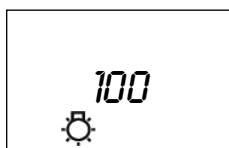

Using the ▼ or ▲ buttons, you can now set the light proportionally as a percentage between 0 and 100%.

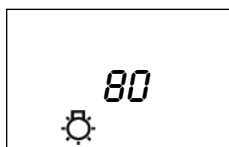

You can adopt the new value by pressing the „**Mode**“ button until the light bulb symbol flashes. Then, the appliance goes back to its normal state by itself.

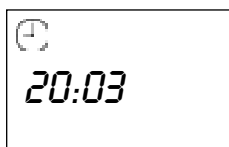
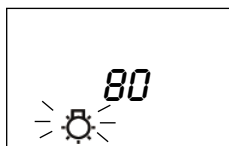

Switching over in IR mode

If your sauna is to be operated in IR mode, you have to activate this first of all. To do this, press the „**Mode**“ button in order to arrive at the programming mode.

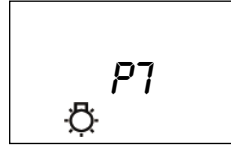

Using the ▼ or ▲ buttons, now select the „**P8**“ programming level.

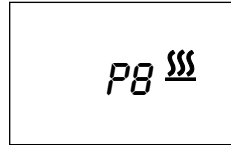

After confirming using the „**Mode**“ button, a „**1**“ and the heating symbol appears in the display.

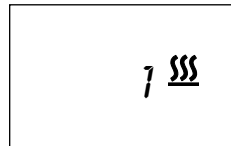

Now press the ▼ button in order to set „**0**“.

0 = IR mode

1 = Finnish or humid mode

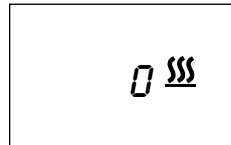

After confirming by pressing the „**Mode**“ button until the heating symbol flashes, the appliance is switched over to IR mode and goes back to its normal state.

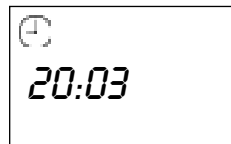
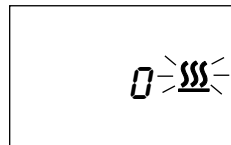

In order to deactivate the IR mode, proceed correspondingly by switching back from „**0**“ to „**1**“.

Programming coloured light (optional)

With the control appliance, it is possible to operate a coloured light appliance in your sauna. Please be aware that for connecting coloured light appliances, the optional colour light module Art. Nr. 942761 has to be installed.

For each colour lighting fixture, the maximum output of 100 W must not be exceeded.

For switching the colour light mode on and off, first actuate the „**Mode**“ button in order to arrive at the programming mode.

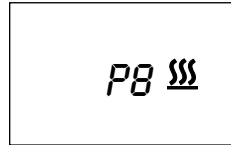

Then, using the ▼ or ▲ button, change to the „**P9**“ programming level.

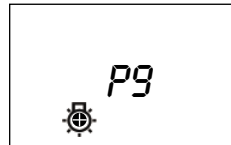

Confirm the entry using the „**Mode**“ button. In the display you will see the coloured light symbol and the value which was last set.



You can then select the switching levels using the ▼ and ▲ buttons.

They mean:

0 = off

1 = automatic mode

2 = permanent red

3 = permanent yellow

4 = permanent green

5 = permanent blue

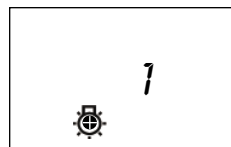

Confirm the entry using the „**Mode**“ button. The coloured light symbol will start to flash.

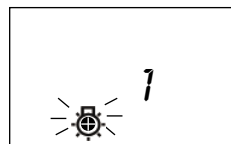

The appliance goes back to its normal state.

Now, each time the sauna is switched on, the selected coloured light mode will be switched on.



If additionally, you want to switch the normal cabin lighting on and/or off, this is of course possible. To do this, actuate the „Light“ button as usual.

The light symbol flashes as long as the cabin lighting is on.



Setting the time interval for the coloured light

This programming option gives you the option of automatically setting the length of time each colour is on. The default is one minute.

You can set on-time to between 1 and maximum 10 minutes.

To program the on-time first press „**Mode**“ to enter the programming mode.

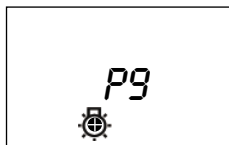

Now, using the ▼ or ▲ button, change to the



After confirming using the „**Mode**“ button, the coloured light symbol next to the time which was last set.

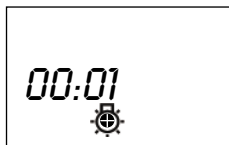

Using the ▼ or ▲ button, you can now set the desired time.

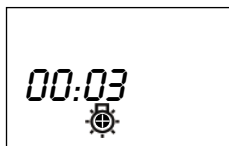

Finally, you can adopt the newly set value by pressing the „**Mode**“ button until the coloured light symbol flashes.

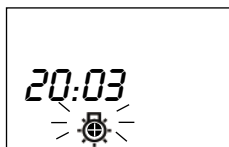

Error

Error display

To quickly diagnose possible errors, use the error code explanation below to ascertain the type of error.

Error code	Error
E 100	Temperature sensor paused
E 101	Temperature sensor short circuit
E 211	Excess temperature fuse paused
E 510	Water-deficit - refill time
E 511	Water-deficit - refill time exceeded
E 600	Terminal supply interruption

The warning symbol  blinks whenever an error message is displayed, so you may easily recognize an error..

To cancel after terminal supply interruption (Error message E600), the entire control has to be disconnected from the mains.

To acknowledge water-deficit detection (Error code E 511), press the MODE-button and restart the unit

Additional errors not displayed and their causes:

The humid mode does not function.

Ensure that the IR mode is deactivated. „P8“ must be at „1“.

There is no display - no background lighting.

Check the mains connection. 230 V is the voltage for stage L.

Check the fuses.

Check the fine wire fuses on the printed circuit board. A 100mA/T type fuse can be used as a replacement.

Connection diagram

WARNING

When connecting the vaporizer, the H1 output terminal controls the sauna heating appliance. The H1 output terminal has no function. The WB terminals must be connected to one another. In this case, the sauna heating appliance heats with reduced output.

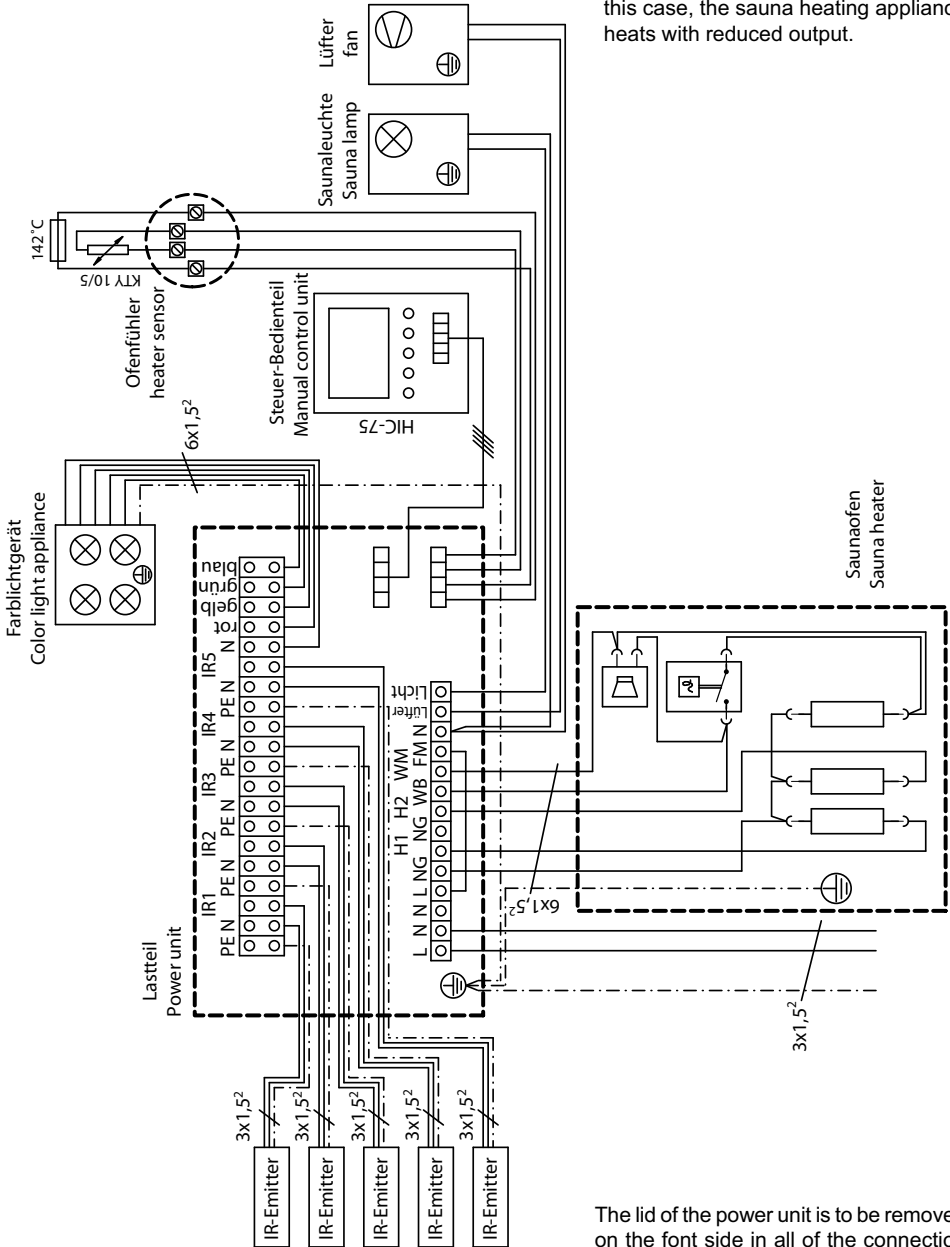

The lid of the power unit is to be removed on the front side in all of the connection possibilities.

Plan of connections for connecting an output switch appliance for a sauna oven with a > 3 kW output

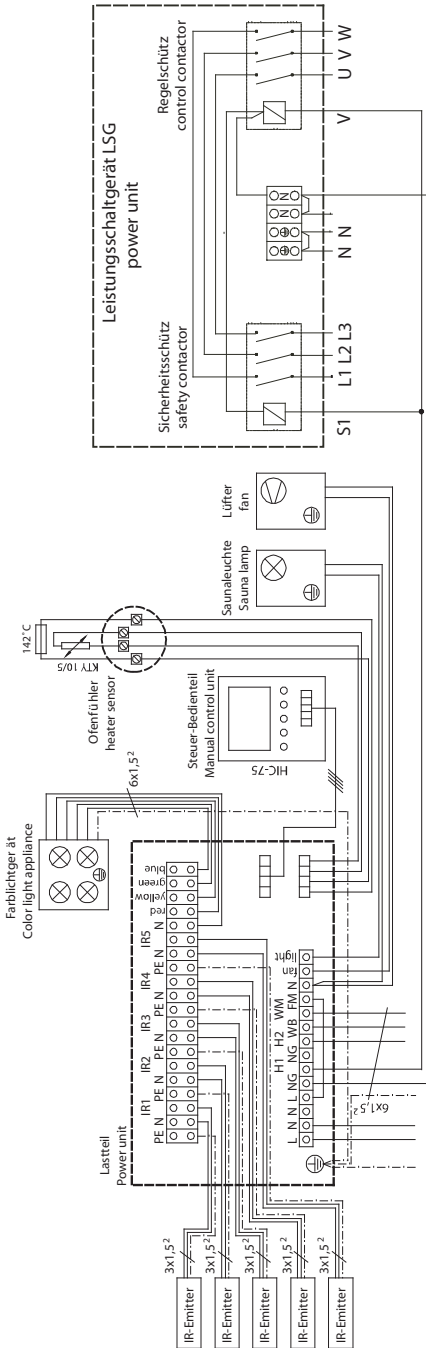

Attention!

Dear customer,
 according to the valid regulations, the electrical connection of the sauna heater and the control box has to be carried out through the specialist of an authorized electric shop.
 We would like to mention to the fact that in case of a warranty claim, you are kindly requested to present a copy of the invoice of the executive electric shop.

Please keep this address in a safe place together with the installation guide.

To help us answer your questions quickly and competently, please provide data printed on the ID plate, to include system type, article no. and serial no., in all inquiries.

Service Address:

EOS-WERKE GÜNTHER GmbH
Adolf-Weiß-Straße 43
35759 Driedorf-Mademühlen, Germany
Fon: +49 (0)2775 82-0
Fax: +49 (0)2775 82-431
servicecenter@eos-werke.de
www.eos-werke.de

Guarantee

The guarantee is taken over according to the legal regulations at present.

Manufacturer's warranty

- The period of warranty starts from the date of purchase and lasts up to 2 years for commercial use and 3 years for private use.
- Always include the completed warranty certificate when returning equipment.
- The warranty expires for appliances which have been modified without manufacturer's explicit agreement.
- Damages caused by incorrect operation or handling through non-authorized persons are not covered under the terms of warranty.
- In the event of a claim, please indicate the serial number as well as the article code number and type name with expressive description of the fault.
- This warranty covers damaged parts but no defects due to wear and tear.

In case of complaint please return the equipment in its original packaging or other suitable packaging (caution: danger of transport damage) to our service department.

Always include the completed warranty certificate when returning equipment.

Possible shipping costs arising from the transport to and from point of repair cannot be borne by us.

Outside of Germany please contact your specialist dealer in case of warranty claims. Direct warranty processing with our service department is in this case not possible.

Equipment start-up date:

Stamp and signature of the authorized electrician:

Handling procedures for return shipments (RMA) - Details for all returns !

Dear customer

we hope that you will rejoice in the ordered articles. Just in case that you are not entirely contented as an exception, please follow the procedures specified below. This enabling us to ensure a quick and smooth handling of the return shipment.

Please absolutely respect for all returns!

- Please add the available **RMA-voucher** always **completely filled out** together with an **invoice copy** to the return shipment! Do not stick it on the goods or on the packaging. **We do not accept the return shipment without these papers.**
- Not prepaid parcels **will be refused** and returned to Sender! Please always ask for the **RMA-No.** for the cheapest return.
- **Please pay attention that** the goods have to be sent back **without visible marks of use** in the **original scope of delivery and in original packing.**
- We recommend to use an **additional solid and break-proof covering box** which should be padded out with styrofoam, paper or similar. Transport damages as a result of faulty packing are for the sender's account.

Form of complaint:

1) Transport damage

- Please check the content of your parcel immediately and advise the forwarding company of a claim (parcel service/ freight forwarder)
- Do not use damaged goods!
- Ask the forwarder **for a written acknowledgement of the damages.**
- **Report the claim promptly by phone to your dealer.** He will discuss with you how to act in this case.
- If the transport box has been damaged, please use an additional covering box. Do not forget to add the **acknowledgement of the damage of the forwarding company !**

2) Faulty goods

- The implied warranty period is 2 years. Please contact your dealer in case of **faulty or wrong articles or missing accessories.** He will discuss with you the individual case and try for immediate and customer-friendly solution.
- For **economic returns** within Germany you will get an **RMA-number from the manufacturer.**
- All returns have to be in the **original packing of the goods with corresponding accessories.** Please repack the goods to avoid damages. In case of wrong delivery, please do not use this article !

3) Problems of installation and functioning

- Please **read the manual carefully first of all** and pay attention to the indicated assembly or installing instructions.
- **Your dealer should be the first contact person** because he knows his products best and also knows possible problems.
- **In case of function problems with an article,** please check at first whether there is an obvious material defect. The quality system in our factory reduces malfunctions of new appliances to almost zero.