

Assembly instruction and user's manual

Z6 / Bi-O Z6



GB

Table of Contents

General notes	3
Important notes.....	4
Electrical connection	5
Technical Data	6
Wiring diagram for sauna ovens 12-27 kW with load balance on the control unit and breaking capacitor	7
Wiring diagram for sauna ovens 12-27 kW with vaporiser max. 3kW with load balance on the control unit and breaking capacitor	7
Wiring diagram for vaporiser > 3kW	7
Installation.....	8
Minimum clearances	8
Installation of Water Gauges.....	9
Electronical connection.....	11
Operation with vaporiser.....	13
Decalcifying the vaporiser.....	14
Sauna stones.....	15
Maintenance and care	15
Service Address:.....	17
Guarantee.....	17
Handling procedures for return shipments (RMA) - Details for all returns !.....	18

Dear Customer,

You have purchased a high quality technical system which will provide you with many years of enjoyable sauna bathing. This sauna heating system was constructed in accordance with state-of-the-art European safety standards, inspected and manufactured in accordance with the Quality Standard EN DIN ISO 9001.

This detailed installation and user's guide was created for your information. Please note especially the important information and the data dealing with the electrical connection.

We wish you a richly invigorating and restorative sauna bathing experience.

First of all, check whether the sauna system has arrived at your site undamaged. Register transport damage claims immediately with the delivering transport company or please consult the supplier who provided the equipment to you.

Intended use

This sauna heater is exclusively designed for the heating of sauna cabins, in connection with an appropriate control unit.

Any use apart from the defined application shall be regarded as non-intended use. Adherence to the conventional operating, maintenance and servicing conditions is also part of the intended use.

The manufacturer cannot be made responsible for deviating alterations undertaken on the authority of the user and any consequential damage. The risk for such measures shall be borne solely by the person carrying out the alterations and causing the damage.

General notes

Please note that an optimal sauna climate can be reached only when the cabin, with its air intake and exhaust, the sauna heating unit and the control unit have been tuned for compatibility with one another.

Please note all data and information provided by your sauna supplier.

The sauna heating units warm your sauna cabin through means of heated convection currents. To this end, fresh air from the air intake vent is drawn in, rises upon warming (convection) and is then circulated through the cabin. A part of the used air is pushed out through the exhaust vent in the cabin. This is the means by which the typical sauna climate develops, reaching characteristic temperatures of about 110° C directly under the ceiling of your sauna, which fall off to about 30-40° C in the floor area due to the temperature gradient in the sauna cabin. Therefore, it is not unusual when, for example, temperatures of 110° C prevail in the area of the temperature sensor over the oven, while the thermometer, which is installed 20-25 cm under the cabin ceiling on the sauna wall, registers only 85° C. With a temperature setting at maximum, the mean bathing temperature lies between 80° C and 90° C in the area of the upper recliner bench.

Please note that the highest temperature values in the cabin always develop in the area above the sauna heating unit and that the temperature sensor and safety limiter must be installed in this area in accordance with the control unit installation guide.





At the initial heating, you may notice a slight odor arising from evaporation of substances from the manufacturing process. Air out your cabin after this cycle before you begin with the sauna bath

Important notes

 **If assembled incorrectly, the system will present a fire hazard. Please read this installation guide thoroughly. It is especially important to consider applicable dimensions and observe the following instructions:**

- This device has not been designed for being used by persons (including children) that are physically or mentally handicapped or have sensory disabilities. Moreover, it is not allowed to use this device without sufficient experience and/or knowledge, unless these persons will be supervised by persons responsible for their security or in case they have been instructed how to use this device.
- Children are to be supervised in order to make sure that they do not play with this device.
-  The installation and connection of the sauna heating unit, control unit and other electrical equipment must be accomplished only by an expert. In this regard it is especially important to meet the required safety precautions in accordance with VDE 0100 v. §49 DA/6 and VDE 0100 part 703/2006-2.
- The sauna heating and control units may be installed only in sauna cabins made of suitable, low resin and untreated material (for example: Nordic pine)
- Only a sauna oven with the appropriate heating capacity may be installed in the sauna cabin (see Table 2).
- There should always be a provision for air intake and exhaust vents in every sauna cabin. The air intake vents must always be aligned behind the sauna heating unit, ca. 5 to 10 cm above the floor. Please use the minimum dimensions of the air intake and exhaust vents listed in Table 1.
- The exhaust vents must always be placed towards the sauna heating unit diagonally in the rear sauna wall, lower area. The

air intake and exhaust vents must not be closed. Please observe the information provided by your sauna cabin supplier.

- For the adjustment and control of the sauna heating unit, one of the control units mentioned later must be used. This control unit must be attached to a suitable location on the outer wall of the cabin, the associated sensor housings in the interior of the sauna cabin in accordance with the installation guide which accompanies the control units.
-  Caution: Covering and improperly filled stone receptacles present a fire hazard.
-  Make certain that no objects have been placed on the sauna heating unit before each start-up.
-  Caution: High temperatures on the heating unit during operation can cause burns on contact.
- The sauna heating unit is not intended for installation or placement in a niche under the bench or under a roof slope.
- Do not start up operation of the sauna heating unit with air intake vents closed.
- The cabin lighting with corresponding mounting must be of a type that it is splash-proof and able to withstand a surrounding temperature of 140° C. Therefore, only a VDE-certified sauna lamp of 40 W maximum may be installed for use with the sauna oven.
-  The sauna system (sauna heating unit, control unit and lighting etc.) may be hard-wired to the power source only by a locally certified electrician. All connecting lines laid on the inside of the cabin must be able to withstand a surrounding temperature of at least 140°C. For practical purposes, a silicone line should be used. If singlewired cables are used as connecting lines, they must be protected by flexible metal tubing. The minimum diameter of the connecting line and the suitable cabin size in proportion to the po-

wer supply capacity are listed in Table 2:

- During the installation of the sauna heating unit, make certain that the vertical clearance between the upper edge of the sauna heating unit and the sauna ceiling is sufficient . The horizontal (lateral) clearance between the sauna heating unit and the cabin wall is provided in the dimension diagram of the respective sauna heating unit. The required distance between the lower edge of the sauna heating unit and the floor is also provided by the dimension diagram. In case of floor-standing ovens, the distance is determined by the base. Fundamentally, it is important to make sure that the sauna heating unit is not placed on a floor that consists of an easily flammable material (wood, synthetic flooring or similar material). Ceramic tiles or similar materials are practical in the area of the sauna.
- The distance between the oven safety grid or recliner bench and other flammable materials and the sauna heating unit are provided in the dimensional data of the respective sauna heating unit. The safety grid height must be approximately equal to the frontal height of the sauna heating unit.

Electrical connection

Your electrician will be able to accomplish this work without further explanation in accordance with the provided wiring schematic and with the help of the circuit diagram mounted inside the respective control unit.

Be sure to note, however, that live wires should not be visibly laid onto the inner cabin walls due to safety considerations. For this reason, the wall element with the air intake vent is already equipped with cable conduits in most sauna cabins

Should there be no cable conduits in your cabin, drill an hole in the cabin wall immediately adjacent to the sauna heating unit where the cable projects from the sauna heating unit and pull the cable through this hole towards the exterior and then to the control unit. The cable as well as all other connecting lines (supply wire to the power source and to the cabin lighting) on the outside wall of the cabin should also be protected from damage, for ex. by installation in cable conduits or by covering with wooden skirting strips.

Technical Data

Voltage: 400 V AC 3N 50 Hz

Power consumption: 12, 15, 18, 21* or 24* kW depending on the version

Evaporation capacity: 2 or 4* kW

Height: 92 cm

key-measured: 59 cm

side-to-side dimension: 67 cm
Stone fill: 30 kg

Leakage current: max. 0.75 mA per kW heating capacity

Sauna oven for use in a professional sauna

Power supply capacity in kW	Minimum dimensions of the air intake and exhaust vents in cm ²
12	300 *
15	
18	
21	400 *
24	

* or in accordance with the instructions of the cabin manufacturer

Table 1

The ovens must be operated via appropriate sauna control units with additional power switch units.

Suitable sauna control devices are:

For sauna oven Z6:

ECON A1 /A2 and EMOTEC DC 9000 in connection with power switch unit ECON L09, EMOTEC L09 or LSG 18.

For sauna oven Bi-O-Z6:

ECON H2 or EMOTEC HCS9003/HIC 75 in connection with power switch unit ECON L09, EMOTEC L09 or LSG 18 H.

Required heating capacity and connected loads							
Heating capacity in kW	Cabin size in m3 (Basis: Manufacture in accordance with RAL for Cabins in Buildings)					minimum diameters mains connection in mm ²	
	14 - 18	18 - 25	24 - 30	24 - 34	35 - 40	Connection to 400V 3N AC	Fuse A
12						5 x 4 ²	3 x 25
15							
18						5 x 6 ²	3 x 35
21							
24						5 x 10 ²	3 x 50

Wiring diagram for sauna ovens 12-27 kW with load balance on the control unit and breaking capacitor

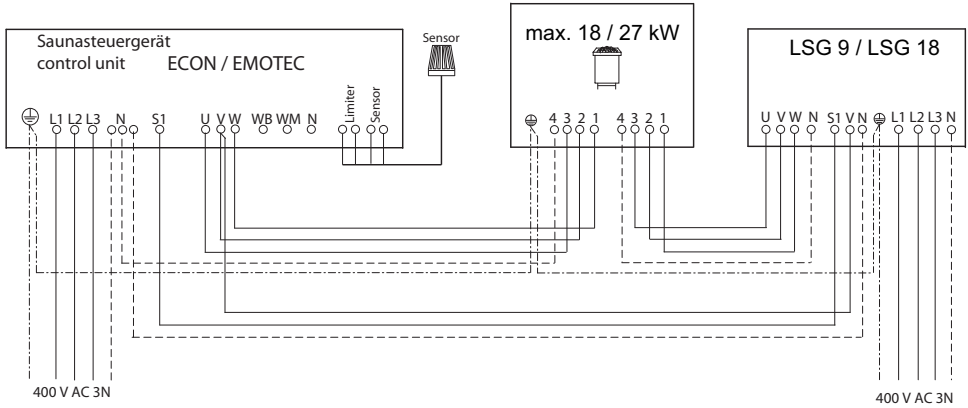

Wiring diagram for sauna ovens 12-27 kW with vaporiser max. 3kW with load balance on the control unit and breaking capacitor

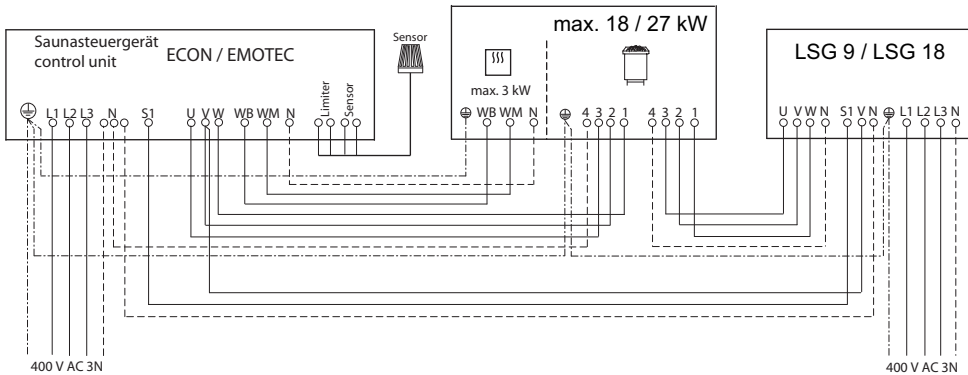

Wiring diagram for vaporiser > 3kW

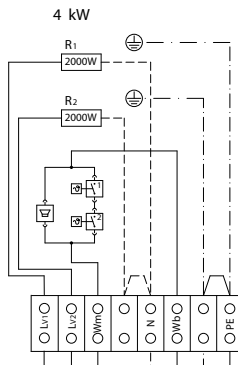

Installation

The sauna oven is intended only for a supply voltage of 400 V 3 N AC

Minimum clearances

The minimum height of the sauna cabin must be 2.10 m on the inside.

During the installation of the sauna oven, make certain that the vertical clearance from the upper edge of the sauna oven to the sauna ceiling is at least 130 cm, and that the horizontal (lateral) clearance between the oven and the cabin wall or other flammable materials is at least 10 cm.

Minimum clearances listed in the following sketches must be observed!

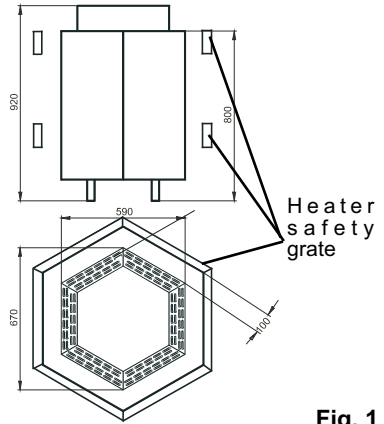

Fig. 1

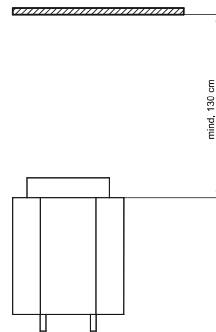

Fig. 2

only **Bi-O-Z6**

Additionally, this heating device is equipped with a vaporiser unit

Please mind that it is necessary to use a control unit for operations with damp hot air.

Select humidity levels according to the specifications given in the operating instructions of the control unit.

Installation of Water Gauges

At first, remove protective foil from exterior mantel.

For protective reasons the glass tube will be supplied unmounted and separately in the packaging. Remove packaging around the glass tube.

Now, loosen nut of the crimp connexion and remove disc and sealing.

Then, insert glass tube from top through both holders (Fig.3).

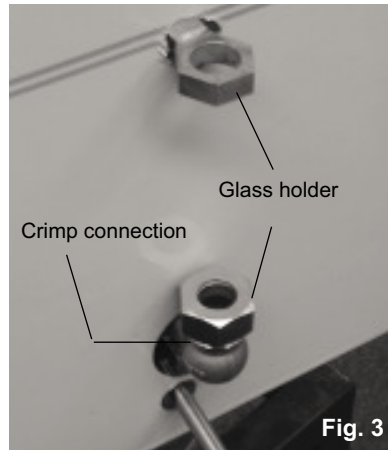

Now, put nut, disc and sealing onto the glass tube (Fig. 4).

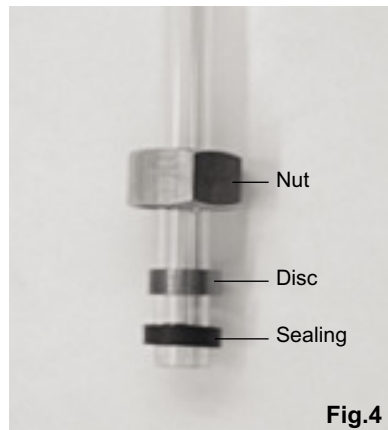

Insert glass tube into screw connexion.
Screw nut on crimp connexion with slight stress (Fig. 5).

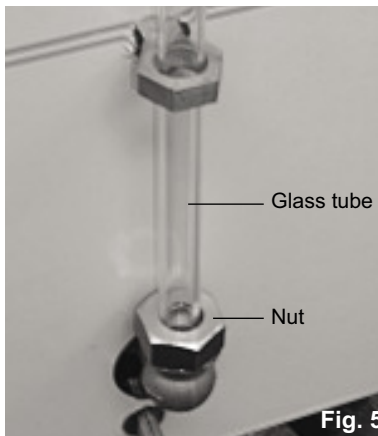

Caution! Do not over-tighten nut - glass might break.

It might be necessary to slightly retighten nut later on.

The upper holder will be used as upper water gauge, the lower holder indicates the minimum water level.

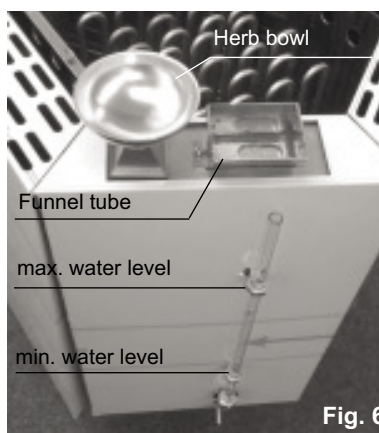

Electronical connection

The ovens Z6 / Bi-O-Z6 are principally wired in a two-circled way. Each heating circuit has a separate connection box.

The connection boxes can be found behind the outer covers.

At first, the stone receptacle must be disassembled. For this, loosen both oppositely arranged fastening screws (Fig. 7) and remove stone receptacle.

Now, in each case remove all three upper (Fig. 8) and lower fastening screws (Fig. 9) of the oppositely arranged mantel sheets and detach them.

Behind the mantel sheets there are the connection boxes. After the fastening screws have been removed the covers of the connection boxes can be removed.

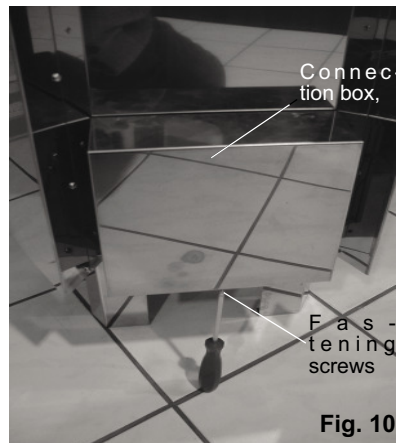
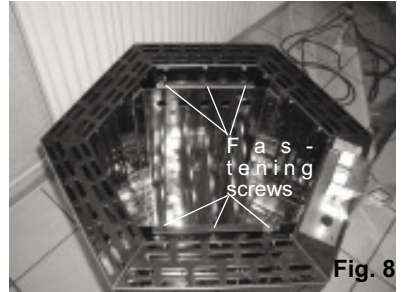
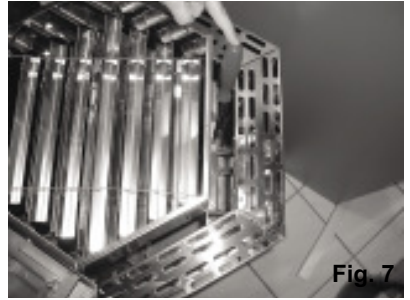

Now, it is possible to complete the connection according to the connection drawing of the sauna control used.

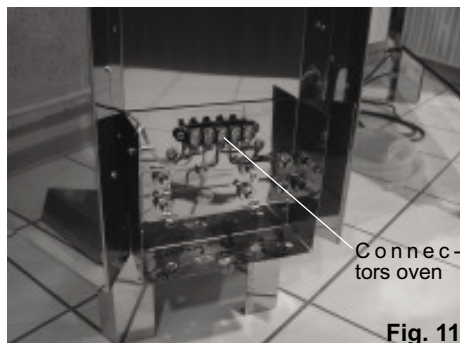

Only Bi-O-Z6

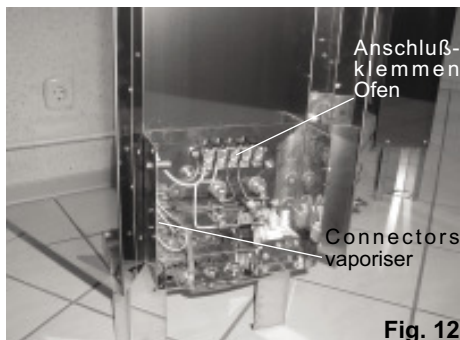

Attention!

Dear customer,
according to the valid regulations, the electrical connection of the sauna heater and the control box has to be carried out through the specialist of an authorized electric shop.

We would like to mention to the fact that in case of a warranty claim, you are kindly requested to present a copy of the invoice of the executive electric shop.

Operation with vaporiser

Fill in water with an appropriate jar into the funnel tube up to the upper mark.

 **Caution:** Burning hazard at steam outlet. Put essences and herbs only into herb bowl.

The vaporiser will be regulated via the control unit. Either you receive a humidity value which is regulated at the sensor via a target/actual comparison, or by means of a clock pulse. Please note that the relative humidity values will vary very strongly due to the unequal distribution of the temperature in the cabin.

The display at the hygrometer and the display at the control unit can thus be very different from each other. Prior to the sauna bath please check whether the water tank is empty.

Remaining water must be let off. Now, fill in water up to the upper water indication into the water tank. This measure will be sufficient for a sauna bath of 2 to 3 hours. Please control the humidity regulation at the control unit.

 **Never add essences, essential oils or herbs to the water, but only to the herb bowl on the top cover of the vaporiser.**

The essential oils released by the hot ascending steam will, automatically be distributed with the ascending steam in the cabin.

If the store of water in the vaporiser has been used up, a humming sound appears and indicates the water shortage. Anyhow, if you want to continue your sauna bath, you can add water into the reservoir after the control unit was put onto „Stop“ for 5 minutes previously or for the same time onto ‚Finnish Sauna‘. The heating rod in the vaporiser must cool down for approx. 5 minutes before cold water can be filled in.

 **Never fill water on a heating rod still glowing. Besides the burning risk the heating rod could be dama**

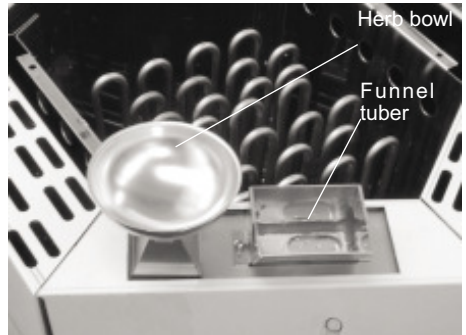



Fig. 13

 **Caution with control units that have subsequent heating times.**

After the humidity bath never leave herb bags in the herb bowl during the subsequent heating time. Then, they dry out very quickly and risk of fire may be caused!

Decalcifying the vaporiser

Ask your supply company for the hardness grade of your water. Within hardness range I (1-7 German hardness degrees) the device usually operates trouble-free and must be decalcified only when necessary.

If your water is within the hardness ranges II - IV, the vaporiser must be decalcified from time to time (depending on the degree of hardness).

For this, add decalcifier for home appliances to the vaporiser water according to the instructions of the manufacturer. Bring to boil the water - decalcifier mixture for approx. 10 min and then have it cooled down. After cooled down let mixture off the vaporiser and rinse afterwards with clear water at least twice. Also consider the instructions of the decalcifier manufacturer.

CAUTION!



With all cleaning or maintenance works, when changing parts or accessory and when removing defects in operating mode, the device must be disconnected from power supply. We wish you many relaxing hours in your sauna.

Sauna stones

The sauna stone is a natural product. Check the sauna stones at regular intervals. Strong infusion concentrates especially can weaken the sauna stones and cause them to disintegrate over time. Consult your sauna supplier if necessary.

Thoroughly clean the sauna stones provided under running water and then place them in the stone receptacle so that the convection air current can circulate easily between the stones (Illust. 9 + 10).

The number of stones is adequate to create a steam burst, vaporizing about 10 cl of water per m³ cabin volume. Always wait 10 minutes after infusion before repeating the infusion. Only then are the sauna stones sufficiently hot.

Never add more infusion agents or volatile oils than instructed on the packaging. Never use alcohol or undiluted concentrates. Caution! Fire hazard!

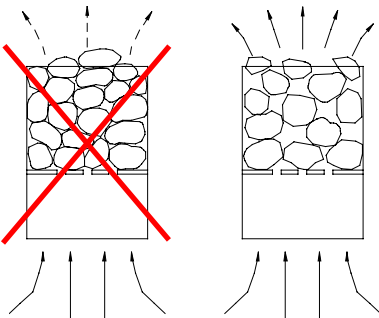

Please be sure to note!



Do not stack the stones in layers; stack them loosely instead, leaving as many spaces as possible to allow the rising hot air to circulate.

Maintenance and care

All sauna heating units are made of low-corrosion material. Still, to enjoy your sauna heating unit for a long time, you should maintain and care for the unit. To this end, always make sure that the vents and reflection plating in the area of air intake are free of objects. These can easily become clogged with fuzz and dust when drawing in fresh air. This reduces the air convection in the sauna heating unit and can be a cause of unacceptable temperatures.

Clean or de-scale the units when needed. Refer to your sauna supplier or directly to the manufacturing plant in case of defects or signs of wear and tear.

Only use original manufacturer's replacement parts, which can be obtained from your supplier or directly from the manufacturer.

If you do not use your sauna for a significant period of time, always check before next use that cloths, cleansers or other objects have not been placed on the sauna heating unit or the vaporizer before turning them on.

Instructions

Leakage current on sauna heaters

For the installation of sauna heaters, please pay attention to the DIN VDE 0100 part 703 !

This standard makes the following statement valid in your newest expenditure, since February 2006, paragraph 703.412.05;

Quotation:

The additional must be planned for all electric circuits of the Sauna by one or more fault current protection device (RCDs) with a calculation difference stream not more largely than 30 mA, excluded of it is Saunaheating.

The EN 60335-1 DIN VDE 0700 part 1 of January 2001 states the following in paragraph 13: quote:

The leakage current may not exceed the following values during operation:

- for stationary heaters of protection class I 0,75 mA; or 0,75 mA each kW input of the appliance, depending on the higher value, at a maximum value of 5 mA.

If the appliance is equipped with a protective device for leakage current (ELCB), please pay attention to the fact that no other electrical units will be protected by this ELCB.

Under current manufacturing methods, it is not yet possible to produce tubular heating elements for sauna heaters which do not attract moisture on each end from the surrounding air.

Therefore, should the ELCB be triggered during start-up, the electrical installation must be checked.

It is also possible that moisture from the surrounding air has been concentrated in the magnesium-oxide filling in the heating elements during transport or storage and is now causing the ELCB to be triggered.

In this case, the oven must be heated up under supervision of an expert, during which the PE conductor is not connected. After about 10 minutes, when moisture has evaporated from

Please keep this address in a safe place together with the installation guide.

To help us answer your questions quickly and competently, please provide data printed on the ID plate, to include system type, article no. and serial no., in all inquiries.

Service Address:

EOS-WERKE GÜNTHER GmbH
Adolf-Weiß-Straße 43
35759 Driedorf-Mademühlen, Germany
Fon: +49 (0)2775 82-0
Fax: +49 (0)2775 82-431
servicecenter@eos-werke.de
www.eos-werke.de

Guarantee

The guarantee is taken over according to the legal regulations at present.

Manufacturer's warranty

- The period of warranty starts from the date of purchase and lasts up to 2 years for commercial use and 3 years for private use.
- Always include the completed warranty certificate when returning equipment.
- The warranty expires for appliances which have been modified without manufacturer's explicit agreement.
- Damages caused by incorrect operation or handling through non-authorized persons are not covered under the terms of warranty.
- In the event of a claim, please indicate the serial number as well as the article code number and type name with expressive description of the fault.
- This warranty covers damaged parts but no defects due to wear and tear.

In case of complaint please return the equipment in its original packaging or other suitable packaging (caution: danger of transport damage) to our service department.

Always include the completed warranty certificate when returning equipment.

Possible shipping costs arising from the transport to and from point of repair cannot be borne by us.

Outside of Germany please contact your specialist dealer in case of warranty claims. Direct warranty processing with our service department is in this case not possible.

Equipment start-up date:

Stamp and signature of the authorized electrician:

Handling procedures for return shipments (RMA) - Details for all returns !

Dear customer

we hope that you will rejoice in the ordered articles. Just in case that you are not entirely contented as an exception, please follow the procedures specified below. This enabling us to ensure a quick and smooth handling of the return shipment.

Please absolutely respect for all returns!

- Please add the available **RMA-voucher** always **completely filled out** together with an **invoice copy** to the return shipment! Do not stick it on the goods or on the packaging. **We do not accept the return shipment without these papers.**
- Not prepaid parcels **will be refused** and returned to Sender! Please always ask for the **RMA-No.** for the cheapest return.
- **Please pay attention that** the goods have to be sent back **without visible marks of use** in the **original scope of delivery and in original packing.**
- We recommend to use an **additional solid and break-proof covering box** which should be padded out with styrofoam, paper or similar. Transport damages as a result of faulty packing are for the sender's account.

Form of complaint:

1) Transport damage

- Please check the content of your parcel immediately and advise the forwarding company of a claim (parcel service/ freight forwarder)
- Do not use damaged goods!
- Ask the forwarder **for a written acknowledgement of the damages.**
- **Report the claim promptly by phone to your dealer.** He will discuss with you how to act in this case.
- If the transport box has been damaged, please use an additional covering box. Do not forget to add the **acknowledgement of the damage of the forwarding company !**

2) Faulty goods

- The implied warranty period is 2 years. Please contact your dealer in case of **faulty or wrong articles or missing accessories.** He will discuss with you the individual case and try for immediate and customer-friendly solution.
- For **economic returns** within Germany you will get an **RMA-number from the manufacturer.**
- All returns have to be in the **original packing of the goods with corresponding accessories.** Please repack the goods to avoid damages. In case of wrong delivery, please do not use this article !

3) Problems of installation and functioning

- Please **read the manual carefully first of all** and pay attention to the indicated assembly or installing instructions.
- **Your dealer should be the first contact person** because he knows his products best and also knows possible problems.
- **In case of function problems with an article,** please check at first whether there is an obvious material defect. The quality system in our factory reduces malfunctions of new appliances to almost zero.