

EMOTEC HCS 9003



GB Assembly and operating instruction

Made in Germany



IP x4

Druck Nr. 29344209en / -08.11

English

Table of Contents

Package contents	4
Optional connections:.....	4
Technical data	5
General information concerning sauna bathing	6
General safety precautions	7
Assembly of the control unit.....	8
Wall mounting.....	8
Electrical connection	9
Connecting the sauna oven	9
Connecting the sauna lamp	10
Connecting a fan	10
Connecting a power control unit.....	10
Connecting a colored light.....	10
Connecting the remote button.....	10
Connecting a GSM module	10
Connecting the phase section module for LED/spot lights.....	10
Connecting the switch module for energy-saving lamps.....	10
Installation diagram	11
Terminal arrangement on the circuit board.....	11
Sensor connection	12
Connection of the vaporizer	12
Connection of sauna heaters ≤ 9 kW	13
Connection of sauna heaters > 9 kW	13
Connecting the sensor lines.....	14
Mounting the oven sensor.....	14
Installing the optional bench sensor.....	15
Connecting the vaporizer	16
Fitting of the humidity sensor (optional)	16

Operation	17
Button functions	17
Symbol description	17
Initial unit switch-on	18
Preset parameters.....	19
Finnish sauna mode.....	19
Temperature display.....	19
Actual - target display.....	19
Heating time.....	19
To consider when programming:.....	20
The hotel mode.....	21
Specialist section	22
F1 Setting the current time.....	22
F2 Programming the reheating period after humid operation	23
F3 Programming the reheating temperature after humid operation	24
F4 Programming the reheating period after humid operation	25
F5 Link color light options with heater.....	26
F6 The optional humidity sensor	27
F8 The optional bench sensor.....	28
F10 Reset time from the submenus	29
Programming levels	30
P1 Starting with the time preselection.....	30
Deactivating the time preselection	31
P2 Heating time limitation	31
Activation of the weekly timer.....	32
P0 Weekly timer	32
P1 Starting with time preselection in weekly timer mode	33
P3 Humid mode	35
Switching back to Finnish Operation.....	36
Switching during humidity operation	36
P4 Humidity setting	37
P5 Temperature setting.....	38
P6 Programming fan operation	39
P7 Ability to dim the cubicle lights.....	40
Coloured light (optional).....	41
P9 Setting the time interval for the coloured light.....	43
The control unit switch (Switch-off)	44
Switching over the heating time limitation for commercial use or weekly timer ...	44
Error display.....	45
Other error options that are not displayed and their causes:	45
Service Address:.....	46
Guarantee	46
Handling procedures for return shipments (RMA) - Details for all returns !.....	47

Package contents

(subject to change)

Included with the control unit are:

1. An oven-sensor board with overheat shutoff protection, KTY-sensors with sensor housing , two 3x25 mm fastening screws and a 2,0 m long sensor cable, red and white.
2. A plastic bag with three 4 x 20 mm fastening screws.
3. A replacement overheat protection module.

Optional connections:



Bench sensor

Art. No: 94.4389



Humidity sensor

Art. No: 90.9479



Colored light module

Art. No: 94.2761



Neon colored light module

Art. No: 94.4286



EmoLux colored light module

Art. No: 94.4834



Remote start button

Art.No: 94.4645

Connection line 10m

Art.No: 94.4646

Connection line 25m

Art.No: 94.4647

Connection line 50m

Art.No: 94.4648



GSM mobile phone remote switch modul Art.No: 94.4671



Phase angle control
module for LED-/Halogen spotlights

Art.No: 94.4970



Control module for energie-saving
(fluorescent) lamps

Art.No: 94.4669

Technical data

Nominal voltage:	400 V 3 N AC 50 Hz
Switching load:	max. 9 kW Ohm resistive load (AC1 - mode) Air conditioning mode: 6 kW + 3 kW for vaporiser device can be extended by connecting powered control units up to 36 kW
Heating time limit:	6 hr, 12 hr or no heating time limit
Display:	Jumbo backlit LCD
Protection class:	IPx4 in line with DIN 40050 splashed water resistant
Normal range for sauna:	30 to 110°C
Normal range for humid mode:	30 to 70°C
With humidity-control without humidity sensor:	me/proportional vaporizing control.
Sensor system:	KTY sensor with safety temperature limiter 142°C
Water level monitoring:	A lack of water in the vaporiser results in automatic shut down after two minutes Lack of water.
Control characteristic:	digital two-point regulation
Fan output:	min. 25W max.100 W max. 500 mA (only fan excluding capacitor)
Light:	min. 25W max. 100W max. 500 mA (ohmic load only. Other lamps have to use with the optional control mo- dules.)
Coloured light (optional):	max. 100 W per colour
Colour on-time:	1 - 10 min
Colour order:	red - red/yellow - yellow - yellow/green - green - green/blue blue - blue/red
-	
Reheatingtime:	0 - 60 min after switching off humidity program
Error display:	via warning triangle (flashing) and error code on LCD
Ambient temperatures:	-10°C to +35°C
Storage temperatures:	-20°C to +60°C



Fuse protection on the light and the ventilation can be a maximum of 0,5 A delay action. There is a danger of fire if greater fuse protection is used!

General information concerning sauna bathing

Dear customer,

with purchase of this sauna control unit you opted for a superior quality, high-tech electronic device which was developed and manufactured according to the highest standards and guidelines.

Please note that an optimal interaction of sauna cabin, sauna oven and sauna control unit is mandatory for a pleasant sauna climate in your cabin.

With this superior sauna control unit you can „operate“ your sauna system, and thanks to the many individual programming settings you will surely soon find the setting that suits you best.

Perception in the sauna is very subjective, therefore it really requires your own perception, or that of your family to find the most suitable settings.

By default the finnish sauna is preset to 95°C. For steam operation the values are set to 60°C and 60% humidity.

The following operation instructions describe how to pre-select „your“ climate in the cabin. Read these instructions carefully, so that you quickly and easily find your way through the programming process.

Please note the variation in temperatures in the cabin while sauna bathing. The hottest area is directly under the cabin ceiling, whereas there is a steady temperature gradient towards the floor of the cabin. Inversely, the relative humidity is lowest directly under the cabin ceiling and the highest on the cabin floor.

For safety reasons the temperature sensor with the overheat safety shutdown is located on the cabin ceiling above the oven, since this is the hottest area in the cabin.

Therefore there will always be temperature variations between the temperature sensor of the control unit and the thermometer in the cabin.

For the cabin light use only light bulbs. Do not use fluorescent lamps, energy saving lamps and gas discharge lamps.

For example, when pre-setting the cabin temperature to 100°C, the thermometer inside the cabin may easily show 85°C - 90°C. This complies with the typical climate inside the cabin.

Always observe hygiene. Always use hand- or bathing towels, to avoid getting perspiration on the wood.

To protect your cabin from possible damages due to steam operation, we recommend reheating or drying the cabin after every steam bath.



In addition, a fan can help to dissipate used humid air in badly ventilated areas.

To avoid the perception of draft, you should avoid using any ventilation system while sauna bathing. It should only be used if recommended by the cabin manufacturer



Always make sure no objects are located on the sauna oven before starting the heating cycle.

General safety precautions

- his device has not been designed for being used by persons (including children) that are physically or mentally handicapped or have sensory disabilities. Moreover, it is not allowed to use this device without sufficient experience and/or knowledge, unless these persons will be supervised by persons responsible for their security or in case they have been instructed how to use this device.
- Children are to be supervised in order to make sure that they do not play with this device.
-  Attention: It is forbidden to install the control box in a closed switch cabinet or behind a wooden panelling!
- The electrical installation may be done only by a qualified electrical technician.
- You must comply with the regulations of your power supply company and applicable VDE regulations (DIN VDE 0100).
-  **WARNING:** Never attempt repairs or installations yourself, as this could result in serious injury or death. Only a qualified technician may remove the housing cover.
- Please note the dimensions in the assembly instructions, especially when installing the temperature sensor. The temperature above the oven is critical for the temperature setting. The temperature can be held within operating parameters and a minimal temperature gradient inside the bench area of the sauna cabin can be achieved only if unit is assembled correctly.
- The device may only be used as intended as a control unit for sauna ovens up to 9 kW. (Up to 36 kW when combined with a breaking capacitor).
- Completely disconnect the control unit from the electrical circuit, i.e. flip all circuit breakers or the main circuit breaker during each installation or repair.
- Please note the safety and installation information from the sauna oven manufacturer.
- Always heed the specifications and instructions of the cabin manufacturer, too.



Attention!

Dear customer,

according to the valid regulations, the electrical connection of the sauna heater and the control box has to be carried out through the specialist of an authorized electric shop

We would like to mention to the fact that in case of a warranty claim, you are kindly requested to present a copy of the invoice of the executive electric shop.

Assembly of the control unit

Wall mounting

Mount the control unit outside the sauna cabin only. The most practical mounting point would be the wall area onto which the sauna oven is mounted on the inside, except on the outside of the cabin. If electrical conduits are present, mount the control unit accordingly. To mount the control unit, please follow these instructions:

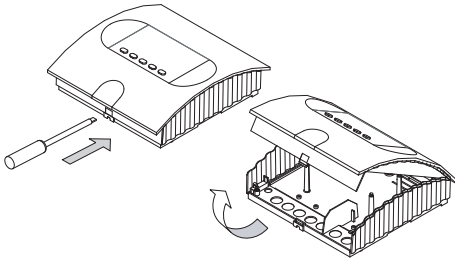

Illust. 1

1. Remove the cover of the control unit. To do this press the fastening tab inwards with a flat screwdriver and remove the housing top by pivoting it upwards (Illustr.1). Drill the threaded holes for the included 4 x 20 mm wood screws according to Illust. 3 & 3.1.
2. Insert one of the wood screws into the upper middle hole. This screw will be the mounting point for the control unit. Make sure the screw is projecting out from wall about 3 mm. (Illust. 3.2)
3. Hang the control unit onto the 3 mm projecting screw. Insert the included rubber sleeves into the openings on the back side of the housing and lead the electrical cable through these openings. Screw the lower part of the housing onto the cabin wall using the lower threaded holes. (Illust. 4)

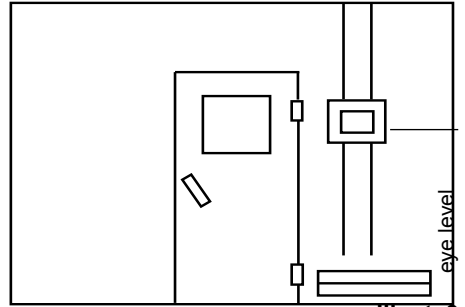

Illust. 3

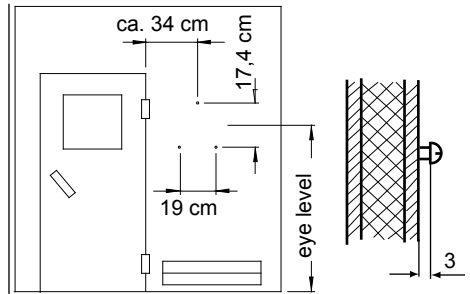

Illust. 3.1

Illust. 3.2

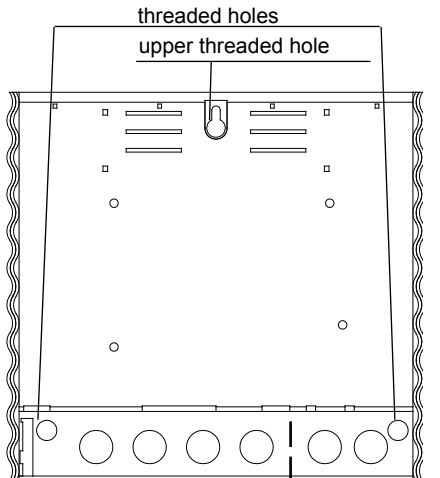

feed-through channel for
power supply lead wire
oven supply line
vaporizer supply line
lamp
fan

feed-through channel for
sensor lines

Illust. 4

Electrical connection

The electrical connection may only be done by a qualified electrical technician under authority of the regulations of the local power supply company and those of the VDE.

In general, there can only be one permanent connection to the power supply network, to include a device which allows the unit to be disconnected from the power source with a contact distance of at least 3 mm from all terminals.

All electrical installations and connector cables inside the cabin must be able to withstand temperatures up to 170°C.

Lead the power cord to the control unit and connect it to the power inlet terminal.



Connecting the sauna oven

Assemble the sauna oven according to the instructions provided by the manufacturer in front of the air intake opening.

Lead the silicone wire to the power control unit through the ducts and connect them to the corresponding terminals according to circuit diagram.

Note: If no ducts are available, bore a hole next to the air inlet opening and pull the stove wire/s to the outside to lead them to the corresponding terminals in the control unit. In order to protect the silicone wire from external impacts it should be covered. Therefore use a suitable cable duct or a PVC pipe in which you lead the wire/s to the power control unit.



Connecting the sauna lamp

The sauna lamp must be weatherproof protected (IPx4) and resistant to the ambient temperature.

The sauna lamp can be mounted at any point, but never near to rising hot air from the heater and as far as possible from the installation position of the IR lamp (may not in the direct beam).



Connecting the remote button

Details can be found in the remote button assembly instructions.



Connecting a GSM module

Details can be found in the GSM module assembly instructions.



Connecting a fan

The fan must be weatherproof protected (IPx4) and resistant to the ambient temperature.

The fan can be mounted at any point, but never near to rising hot air from the heater and as far as possible from the installation position of the IR lamp (may not in the direct beam).



Connecting the phase section module for LED/spot lights

Details can be found in the switch module assembly instructions.



Connecting the switch module for energy-saving lamps

Details can be found in the switch module assembly instructions.



Connecting a power control unit

Details can be found in the power control unit assembly instructions.



Connecting a colored light

Details can be found in the colored light assembly instructions.

Installation diagram

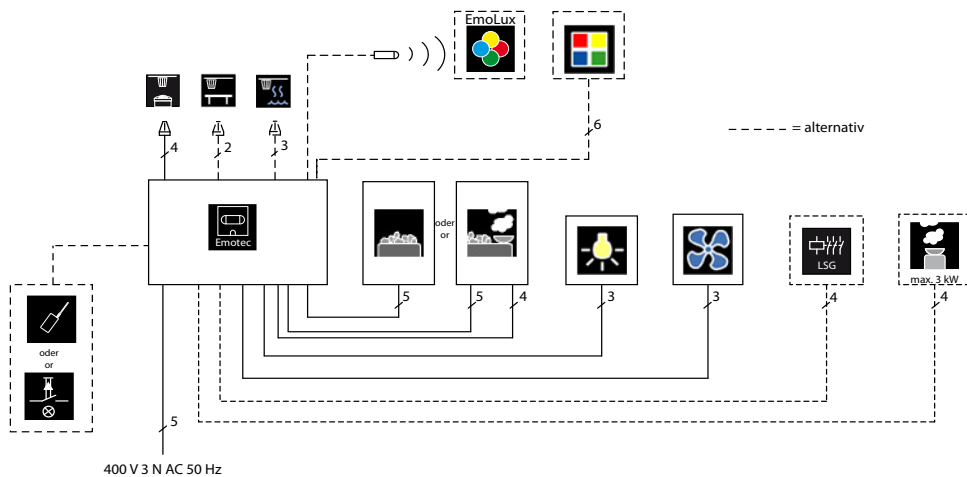

Terminal arrangement on the circuit board.

(Power unit)

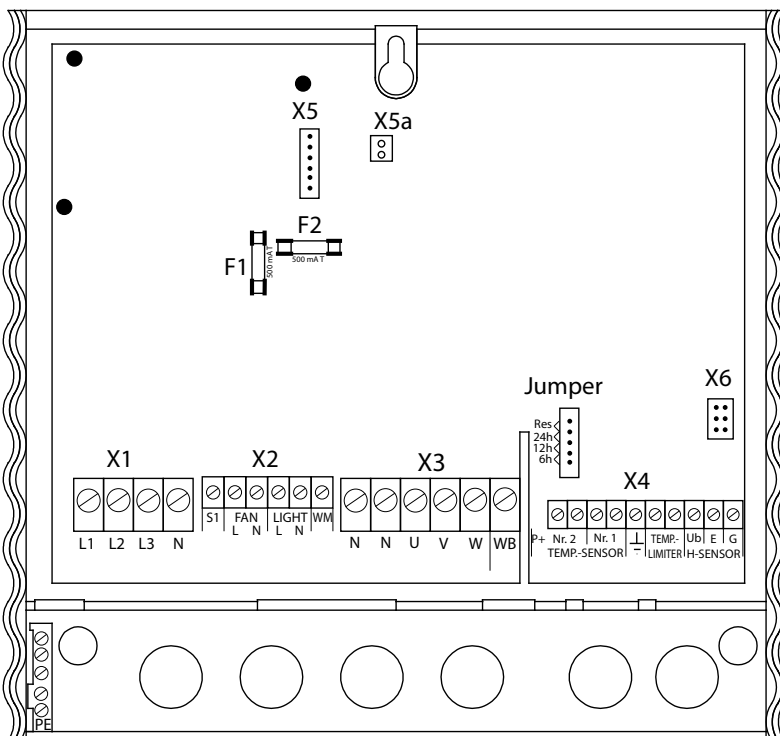

Sensor connection

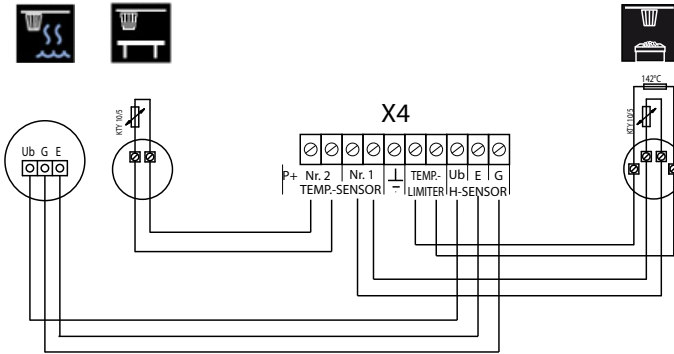

Connection of the vaporizer

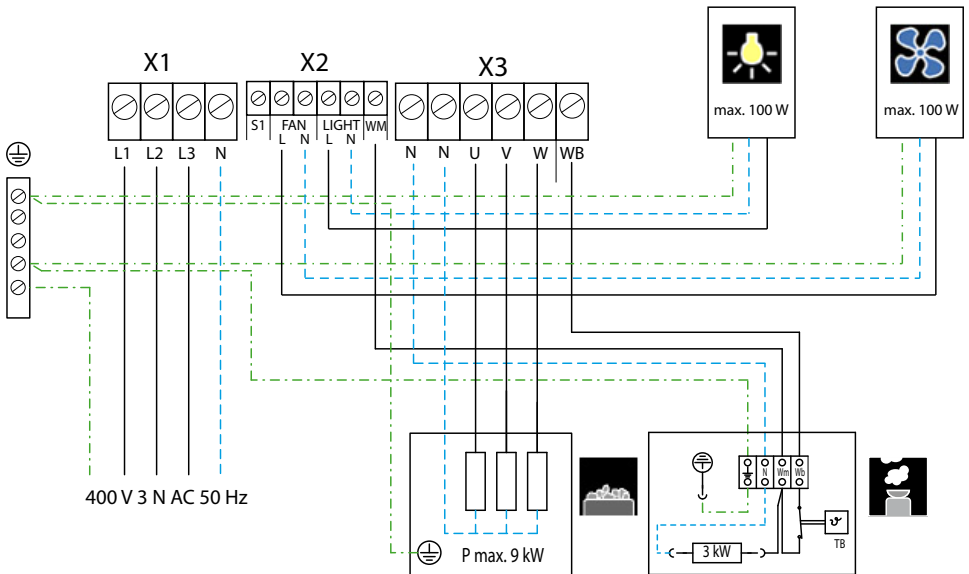

CAUTION

When connecting the vaporizer the output “W” is switched from the sauna heater to the terminal “Wb” to the vaporizer.

In this case, the sauna heater heats only with two thirds of the power.

Connection of sauna heaters ≤ 9 kW

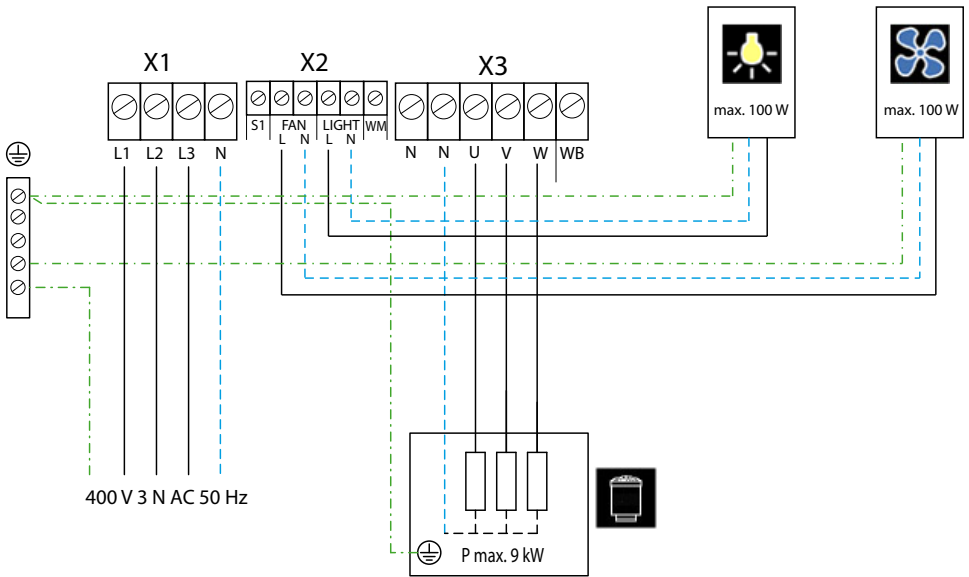

Connection of sauna heaters > 9 kW

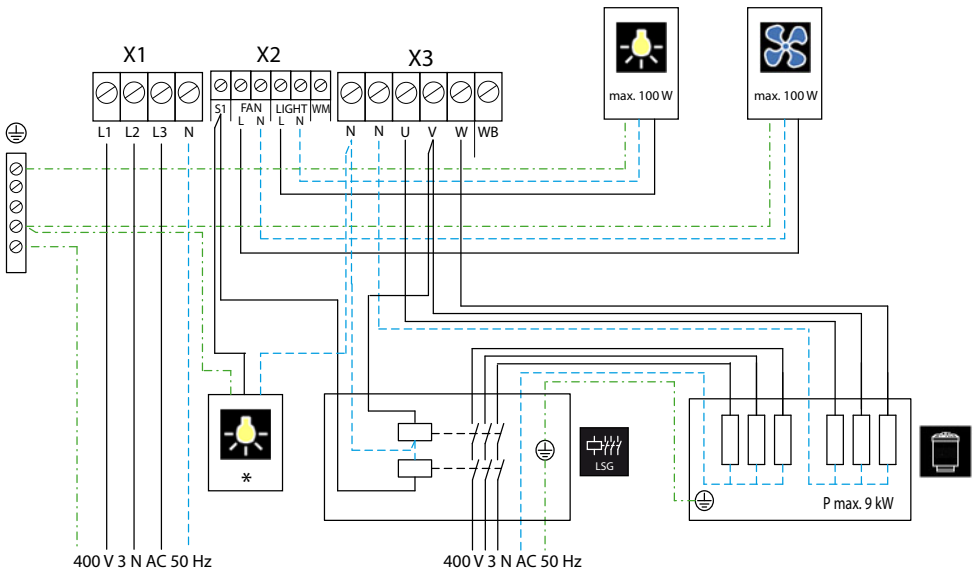

* For public installations without heating time limitation, the pilot light must be installed in the control room.

Connecting the sensor lines

You should not install sensor and power supply lines together, or lead them through the same conduit. This can lead to interferences in the electronics, such as „fluttering“ in the relays. If it is absolutely necessary to install them together, or the wire is longer than 3m, you should use a shielded sensor line such as the LIYLY-O x 0.5 mm²). Connect the shielding to mass in the control unit.

Please note that the following measurements are based on values provided by the unit quality assurance by the European Standard EN 60335-2-53. In principle, you must mount the oven sensor where temperatures are expected to be the highest. Illust. 7 gives you an overview of the mounting point of the sensor.



Mounting the oven sensor

1. Mount the oven sensor in cabins up to 2 x 2m according to Illust. 7 and 8, in larger cabins according to Illust. 7 and 9.

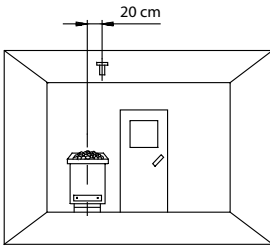

Illust. 7

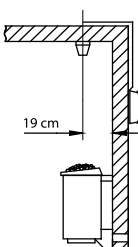

Illust. 8

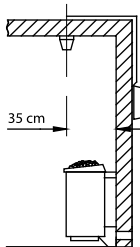

Illust. 9

2. Drill a hole to lead the cable through, preferably through the middle of one of the wooden boards.
3. Lead the sensor cable through the drilled hole and attach it to the sensor line according to Illust. 10.
4. Attach the lines for the shutoff (white) and the temperature sensor (red) according to Illust. 11 to the sensor board. Then insert the sensor board into the housing.
5. After you are finished installing and have made sure the control unit is functioning properly, check the line for overheat shutoff protection for short circuits. To do this, release one of the white lines in the sensor housing. The safety relay of the control unit should now fall; i.e. the heating circuit should now be interrupted.

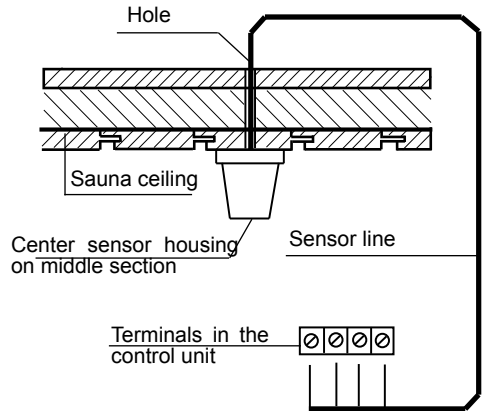

Illust. 10

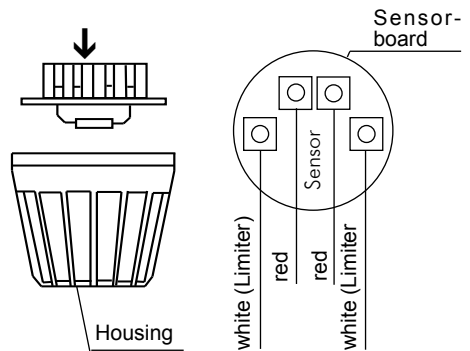

Illust. 11



Installing the optional bench sensor

Installation location: The bench sensor is fixed to the ceiling of the rear reclining bench as described for the installation of the heater sensor.

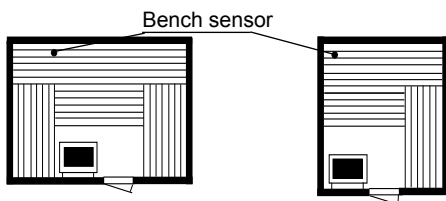

The bench sensor is connected via a 2-wire silicone cable on the control unit to the terminals on the right-hand side of the lower board. The terminals are marked „Temp.-Sensor Nr. 2“.

If there is a problem with the bench sensor, a fault message will appear:

E 103 = Interruption bench sensor

or

E 104 = Short-circuit bench sensor

In this case, the sensor must be checked by an expert and replaced if necessary. At room temperature, the sensor has approx. 2 kΩ.

After disassembly the sensor can be deactivated so that you can use your sauna despite the problem. See the ‚Bench sensor‘ chapter for more details.

Once the problem has been solved, the control unit recognises the sensor once the mains voltage has been switched on again.

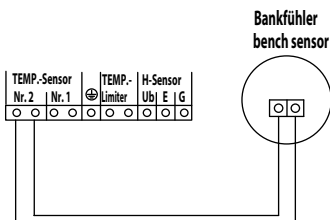

When the sensor is connected correctly, the control unit automatically recognises the sensor once the mains voltage has been switched on again..



Connecting the vaporizer

To connect the vaporizer, use silicon connecting lines 4 x 1,5 mm² as well.



Warning: When connecting the vaporizer make sure it is correctly attached to the water bath (WB) and low water shutoff (WM). If you switch these connections, you disable the water deficiency function and bypass the thermostat. As a result, the vaporizer will overheat.

This is a fire hazard!!

Illust. 6 shows the circuit diagram. The control unit can detect water deficit if there is a zero-potential feed at the WM-input.

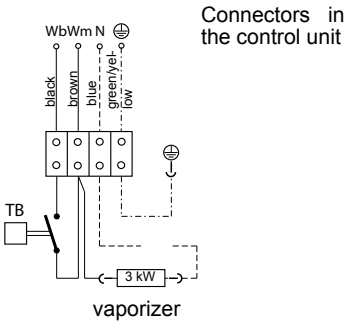

Illust. 6



Fitting of the humidity sensor (optional)

1. The humidity sensor is fitted in the centre of the sidewall facing away from the oven at a height of approximately 150 cm.
2. See illust. 12 for the connection sequence of the strands.
3. Ensure the connection is exactly correct-incorrect connections can lead to defects in the sensor.

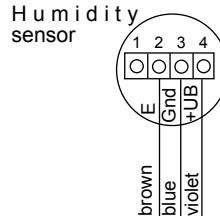

Illust. 12

The sensors are connected to the clamps at the lower right outer edge of the control unit in accordance with the following scheme.

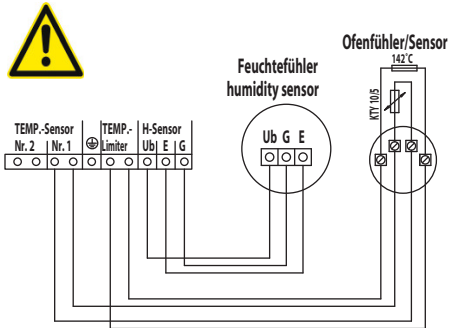

Warning: Always connect the neutral conductor of the sauna oven. During steam operation, one phase of the oven is shut down; therefore the heating load is no longer symmetrical. The result is that the neutral wire is no longer current-free.

Programmed maximum values EN 60335-2-53:2003

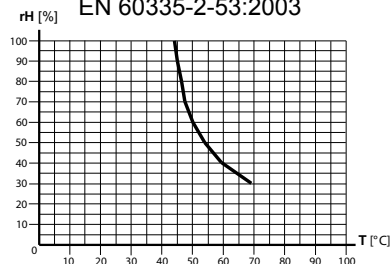

Operation

Button functions

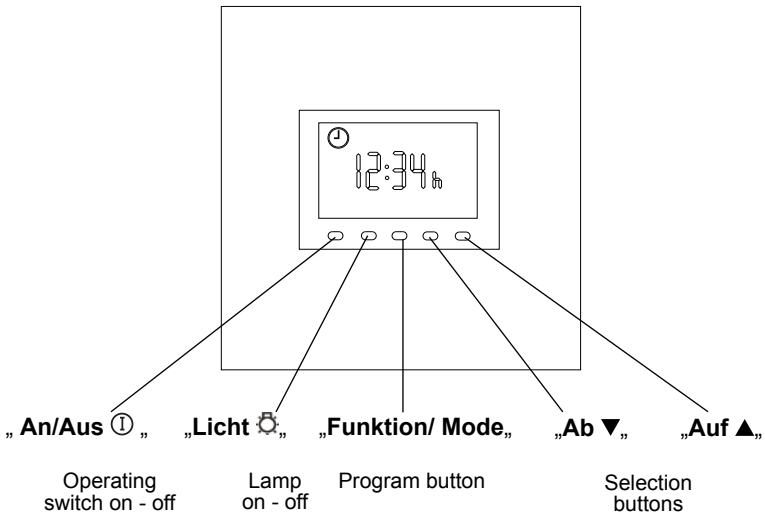

Symbol description

	Time		Heating and steam (2 phases + vaporizer)
	Pre-selected time		Heating
	Heating time		Ventilation function
	Steam operation		Coloured light
	Lamp		Error message

If the control box does not pick off voltage after closure, please check the position of the control box switch (Switch-Off). See chapter about „control box switch (Switch-Off)“ at the end of this manual.

Initial unit switch-on

After you have checked all of the connections once again, connect the unit to the mains by switching on all fuses or the main switch.

The time appears on the display.

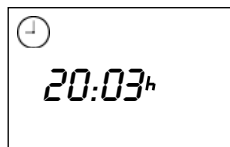

If the display flashes, proceed as follows:

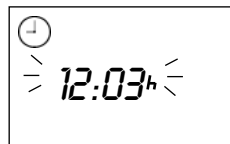

With the buttons "**Ab ▼**" and "**Auf ▲**", you can set the required values.



Confirm with the "**Funktion/Mode**" button.



The display shows "**F1**" shortly afterwards.

Afterwards, the current time is shown on the display and the unit is ready for use.

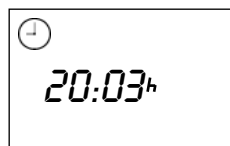

To change the time refer to chapter "**F1**" of this operating manual.

The unit is switched on using the left "**An/ Aus ⓘ**" button. The cabin lighting and the background display illumination are switched on at the same time.

Shown on the display:

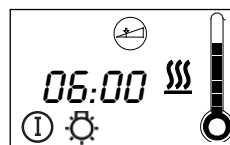

Preset parameters

Finnish sauna mode

After switching on, the display alternates between showing the current time and the remaining heating time.



Temperature display

During the heating phase plus approx. 15 minutes, the thermometer symbol continues to fill.

The control phase begins once the end temperature is reached. The thermometer filling now continually shows the temperature on the sensor.

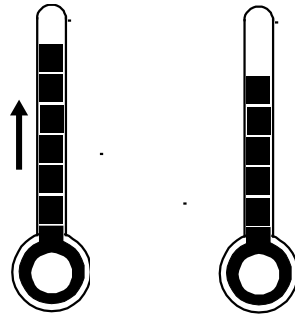

Heating phase

Control phase

Actual - target display

By pressing the "Auf ▲" button for more than 3 seconds, you can show the actual temperature on the heater.

If a bench sensor is installed, you can show the temperature at bench level by pressing the "Ab ▼" button for more than 3 seconds.

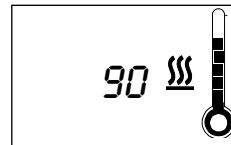

Heating time

The factory has limited the heating time to 6 hours. This means that the unit switches off after 6 hours due to safety reasons.

The display alternates between showing the current time and the remaining heating time.

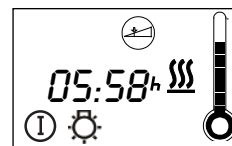

If the sauna bath should be finished beforehand, press the **"An/Aus ⓘ"** button. The symbol distinguishes on the display and only the current time is still displayed.

The cabin lighting automatically switches off after 30 minutes. You can switch the lighting off at any time using the **"licht ⚙"** button.

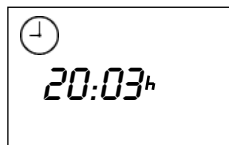

To consider when programming:

The buttons to be confirmed are shown and quoted in the text as follows.



Symbols shown in the display sketches, framed with the symbols , are displayed flashing on the unit.

Any change to the set parameters must be saved by pressing the **"Funktion/Mode"** button. The respective newly set values flash briefly before the unit switches back to the basic display.

If you change the parameters without saving with the **"Funktion/Mode"** button, the previous values are automatically reactivated.

If you do not operate the unit for a longer period during programming, the display automatically returns to the basic display and the background illumination goes out after a brief period.

The hotel mode

By activating the hotel mode, the sauna can only be switched on and off by the user. Changes to the individual parameters are not possible.

To activate the hotel mode, press the **"Mode"**, **"▼"** and **"▲"** buttons at the same time until the display shows **"SAFE"**.

The display returns to the original status when the buttons are released.

If other buttons are pressed than the **ⓘ** button, the display shows **"SAFE"**.

To deactivate the hotel mode, press the **"Mode"**, **"▼"** and **"▲"** buttons at the same time longer than 3 seconds.

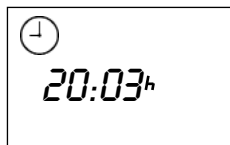

The various programming options for the unit are generally differentiated into:

Specialist levels

The levels are described with **"F 1 - F 10"**. Depending on the unit type it may be the case that the individual levels are not shown. The parameters can be changed here if they only have to be adapted very rarely in daily use. They are set after being newly installed and then are usually maintained for a longer period.

Programming levels

The levels are shown with **"P 0 - P 9"**. Depending on the unit type or set operating mode, it may be the case that the individual levels are not shown. The parameters can be changed here if they have to be frequently adapted to your individual requirements in daily use.

Specialist section



F1 Setting the current time

For clock time adjustment please press „**Mode**“ and „**▲**“ button synchron.

(In the display appears „**F1**“ and the clock symbol.)

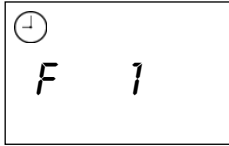

Please confirm with the „**Mode**“ button.



Please chose the wished value with the „**▼**“, and „**▲**“, buttons.

(to switch between **summer and winter time** for example)



Please confirm with a long press on the „**Mode**“ button until the new value is flashing on the display.

Afterwards the displays shows „**F1**“ for short time





F2 Programming the reheating period after humid operation

The heating time limiter is fixed at 6 hours.

For pre heating time adjustment please press „**Mode**“ and „**▲**“ button synchron.

(In the display appears „**F1**“ and the clock symbol.) Afterwards press „**▲**“, button until „**F2**“ in the display appears.

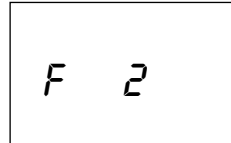
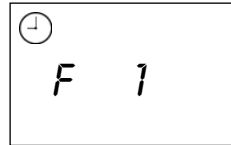

Please confirm with the „**Mode**“ button.

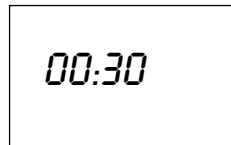

Please chose the wished value with the „**▼**“ and „**▲**“, Please chose the wished value with the

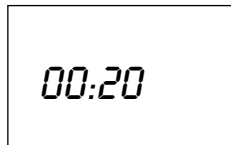

Please confirm with a long press on the „**Mode**“ button until the new value is flashing on the display.

Afterwards the displays shows „**F2**“ for short time. The post heating time is now fixed with the new value.

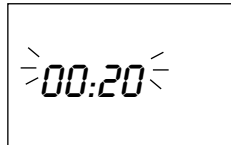



F3 Programming the reheating temperature after humid operation

The factory sets the reheating temperature to 95°C. This means that after humid operation the furnace heats up to 95°C during the pre-selected reheating time to dry the cubicle.

For post heating temperature adjustment please press „**Mode**“ and „▲“ button synchron.

(In the display appears „F1“ and the clock symbol.) Afterwards press „▲“, button until „F3“ in the display appears.

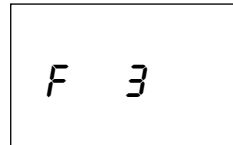
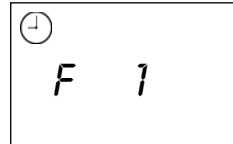

Please confirm with the „**Mode**“ button.

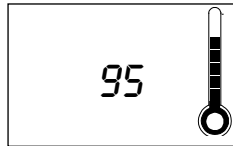

Please chose the wished value with the „▼“, and „▲“, buttons.



Please confirm with a long press on the „**Mode**“ button until the new value is flashing on the display.

Afterwards the displays shows „F3“ for short time. The post heating temperature is now fixed with the new value.





F4 Programming the reheating period after humid operation

By default the water-deficit safety shutoff is set to 2 minutes. This means, should your oven report a water-deficit, you have 2 minutes to refill it.

If the water-deficit warning runs for more than 2 minutes, the control unit shuts the entire sauna system off for safety reasons.

For switch off time adjustment please press „**Mode**“ and „**▲**“ button synchron.

(In the display appears „**F1**“ and the clock symbol.) Afterwards press „**▲**“, button until „**F4**“ in the display appears.

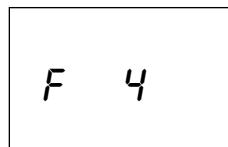
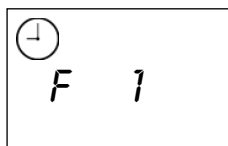

Please confirm with the „**Mode**“ button.

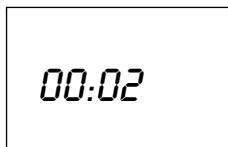

Please chose the wished value with the „**▼**“, and „**▲**“, buttons.

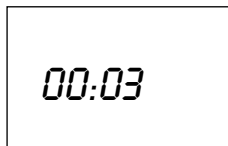

Please confirm with a long press on the „**Mode**“ button until the new value is flashing on the display.

Afterwards the displays shows „**F4**“ for short time. The switch off time is now fixed with the new value.

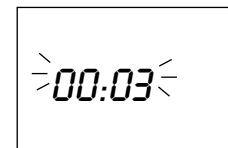

For safety reasons the maximally adjustable time is limited on 5 minutes.

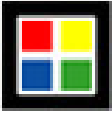

F5 Link color light options with heater

In order to link the coloured light functions with the heater, press the **"Funktion/Mode"** and the **"Auf ▲"** button at the same time (**"F1"** and the clock symbol appear on the display) and then the **"Auf ▲"** button until **"F5"** appears on the display.



Confirm with the **"Funktion/Mode"** button.

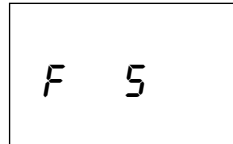

With the buttons **"Ab ▼"** and **"Auf ▲"**, you can now set the required value.



0= The colour light function is linked with the heater function.
i.e. the colour light automatically turns on if the heater is initialised..

1 = The color light function is not linked with the heater function

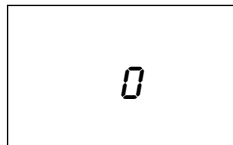

Confirm the entry by permanently pressing the **"Funktion/Mode"** button until the newly set value flashes on the display.

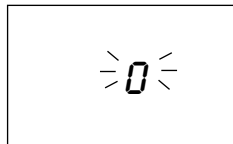

Afterwards, the **"F5"** is briefly shown until the display issues the basic display.



F6 The optional humidity sensor

To activate or deactivate the F2 humidity sensor (after new installation or after error)

please press „**Mode**“ and „**▲**“ button synchron.

(In the display appears „**F1**“ and the clock symbol.) Afterwards press „**▲**“, button until „**F6**“ in the display appears.

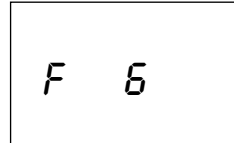
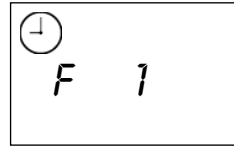

Please confirm with the „**Mode**“ button.



Please chose the wished value with the „**▼**“, and „**▲**“, buttons.

1: Humidity sensor activated

0: Humidity sensor deactivated

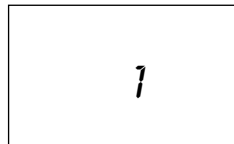

Please confirm with a long press on the „**Mode**“ button until the new value is flashing on the display.

Afterwards the displays shows „**F6**“ for short time. The figure is now fixed with the new value.

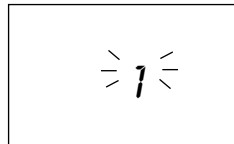



F8 The optional bench sensor

To activate or deactivate the bench sensor
(after error)

please press „**Mode**“ and „**▲**“ button syn-
chron.

(In the display appears „**F1**“ and the clock
symbol.) Afterwards press „**▲**“, button until
„**F8**“ in the display appears.

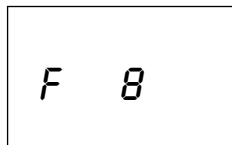
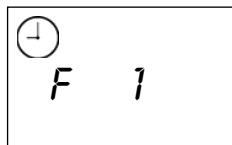

Please confirm with the „**Mode**“ button.

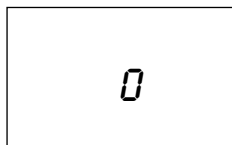

Please chose the wished value with the „**▼**“, and „**▲**“, buttons.

1: bench sensor activated

0: bench sensor deactivated

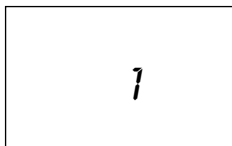

Please confirm with a long press on the
„**Mode**“ button until the new value is flas-
hing on the display.

Afterwards the displays shows „**F8**“ for
short time. The figure is now fixed with the
new value.

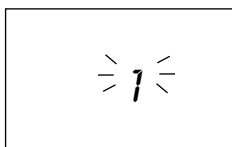

F10 Reset time from the submenus

To set the reset time on submenus (the time after which the display automatically resets to the basic display), press the **"Funktion/Mode"** and **"Auf ▲"** buttons at the same time (**"F1"** and the clock symbol appear on the display) and then the **"Auf ▲"** button until **"F10"** appears on the display.



Confirm with the **"Funktion/Mode"** button.



Using the **"Ab▼"** and **"Auf ▲"** buttons, you can now set the required value.

5 = 5 seconds

8 = 8 seconds

12 = 12 seconds

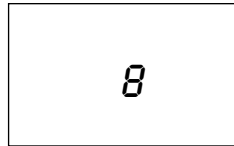

Confirm the entry by permanently pressing the **"Funktion/Mode"** button until the newly set value flashes on the display.



Afterwards, the **"F10"** is briefly shown until the display issues the basic display. The reset time will now always accord with the entered value.

Programming levels



P1 Starting with the time preselection

With time preselection, you may preselect the start of your sauna unit within 24 hours.



Always make sure that there are no objects on the sauna unit before the heating process begins. Risk of fire!

In order to set the time preselection, please press the "**Funktion/Mode**" key. The preselection symbol and "**P1**" will appear on the display.

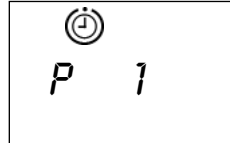

Confirm with the "**Funktion/Mode**" key.



With the keys "**Ab ▼**" and "**Auf ▲**", you can now set the required value in 10-minute steps.

Keep in mind that the cabin must heat up for ca. 40 – 50 minutes in order to reach a comfortable climate inside the cabin. If, for example, you wish to start with your sauna bath at 18:00 hrs, please select 17:10 hrs as your preselection time.



Confirm the entry by permanently pressing the "**Funktion/Mode**" key until the newly set value flashes on the display.



Afterwards, the "**P1**" is briefly shown.

Whilst the "**P1**" is visible on the display, please press the "**An/Aus** " key to start the preselection mode.

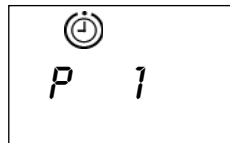

After a short period of time, the current time and the preselected switch-on time are shown alternately on the display. The background illumination on the display goes out.

Once the preselection time has been reached, the sauna unit will switch on. After the heating period has ended, the device switches the unit off automatically.

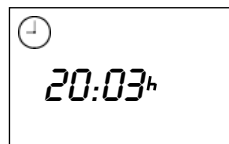

Deactivating the time preselection

In order to deactivate the time preselection, please press the **"An/Aus ⓘ"** key. Then the sauna oven will be switched on. By pressing the **"An/Aus ⓘ"** key again, the sauna oven is switched on.



P2 Heating time limitation



This program step will only appear if the device has not been prepared for the "Wochentimer" mode during installation.

The heating period is limited to 6 hours on delivery. After this time has elapsed, your sauna will switch off automatically.

In order to set the maximum heating time, press the **"Funktion/Mode"** key and then the **"Auf ▲"** key until the heating time symbol and **"P2"** appear.

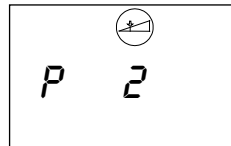

Confirm with the **"Funktion/Mode"** key.

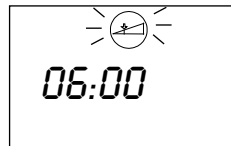

Using the **"Ab ▼"** and **"Auf ▲"** keys, you can now set the required value.

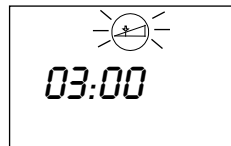

Confirm the entry by permanently pressing the **"Funktion/Mode"** key until the newly set value flashes on the display.



Afterwards, the **"P2"** is briefly shown until the display issues the basic display. The maximum heating time will now always accord with the entered value.



P0 Weekly timer



This program step will only appear if the device has been prepared during installation for the "Wochentimer" mode.

You can program up to 4 preselection times for each week day in the weekly timer menu.

The heating time per preselection time can be between 30 minutes and 12 hours. After 12 hours, a heating break of 6 hours starts automatically.

Manual switch-on of the sauna system is possible at any time. The weekly automatic setting is inactive during this time. If the heating time limitation (6 h) or the user switches the system off in this time, the weekly timer becomes active again.

Upon initial start-up or after a longer period disconnected from the mains (time lost), the weekly timer is deactivated.

Activation of the weekly timer

Setting the current day of the week

In order to activate the weekly timer, press the **"Funktion/Mode"** key and then the **"Auf" ▲** key until the preselection symbol and **"P0"** appear on the display.

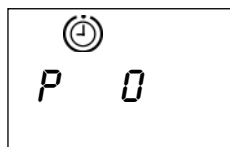

Confirm with the **"Funktion/Mode"** key.

Using the **"Ab▼"** and **"Auf▲"** keys, select the current day of the week.

- 0 = Weekly timer deactivated
- 1 = Monday
- 2 = Tuesday
- 3 = Wednesday
- 4 = Thursday
- 5 = Friday
- 6 = Saturday
- 7 = Sunday

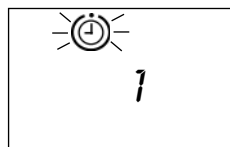
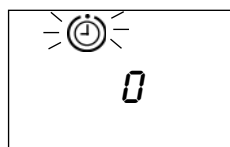

Confirm the entry by permanently pressing the **"Funktion/Mode"** key until the newly set value flashes on the display.

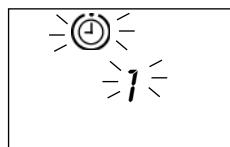

Afterwards, the **"P0"** is briefly shown until the display issues the basic display. The weekly timer is now activated and the current day of the week is set.



P1 Starting with time preselection in weekly timer mode



Always make sure that there are no objects on the sauna unit before the heating process begins. Risk of fire!

In order to set the time preselection, please press the "**Funktion/Mode**" key. The preselection symbol and "**P1**" will appear on the display.

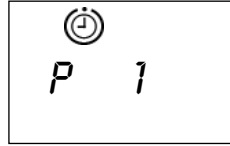

In order to set the time preselection, press the "**Funktion/Mode**" key. The preselection symbol will appear on the display as well as "d 1:1". (d<Wochentag 1...7>:<Programm 1...4>)



With the keys "**Ab ▼**" and "**Auf ▲**" you can select the required day and the program item.

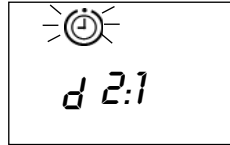

Confirm the entry by pressing the "**Funktion/Mode**" key. The switch-on time last set will appear on the display.

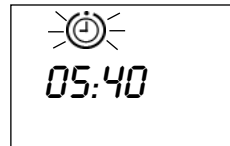

With the keys "**Ab ▼**" and "**Auf ▲**", please set the required switch-on time.

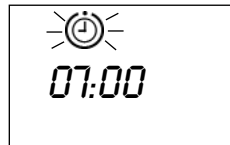

Confirm the entry by pressing the "**Funktion/Mode**" key until the newly set value flashes on the display. After this the heating time symbol will start to flash on the display and the last set heating time.

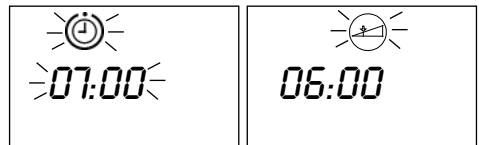

With the keys "**Ab ▼**" and "**Auf ▲**" you can set the required heating time.



 If the control is running in moist mode, the time set here is the total time including the reheating time set in F2.

If the heating time is set to the maximum value of 12 h, a heating break of 6 h is switched on once this 12 h period has ended.

Confirm the entry by pressing the "**Funktion/ Mode**" key until the newly set value flashes on the display. The preselection symbol appears on the display as well as "d 2:2".

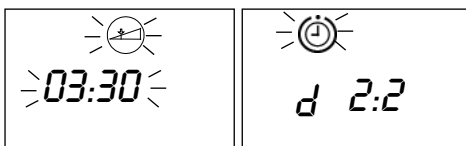

You can undertake further time preselections in the same way.

 The control prevents the set programs from overlapping during programming. A break of at least 10 minutes is automatically maintained between two programmes.

This does not apply for the maximum heating time of 12 h; here the heating period is 6 h.

The display reverts to the standby display after a brief period of time.

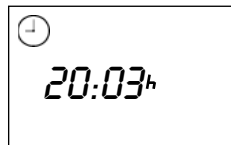

10 minutes before a program begins, the preselection time is shown alternating with the time of day in the display.

In this time and during the automatic heating phase, the time of day cannot be changed in the "F1" menu.

In order to switch on manually in this time, the preselection time must initially be deactivated by pressing the "**An/Aus** 

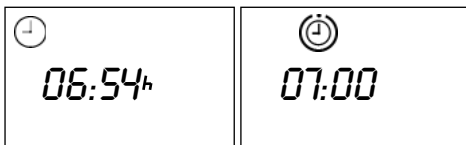

 If "-:--" is selected as the preselection time, the appropriate program is deactivated.



P3 Humid mode

For humidity operation adjustment please press „**Mode**“ button.

Afterwards the „**▲**“, button until in the display the humidity symbol and „**P3**“ appears.

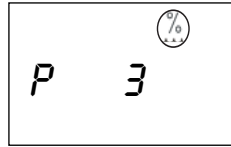

Please confirm with the „**Mode**“ button.

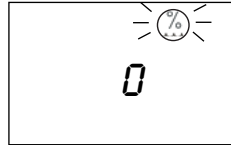

Please chose the wished value with the „**▼**“, and „**▲**“, buttons.

0 = Finnish operation

1 = Humidity operation

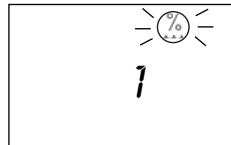

Please confirm with a long press on the „**Mode**“ button until the new value is flashing on the display.

Afterwards the displays shows „**P3**“ for short

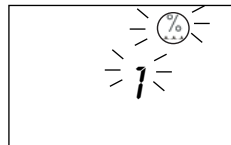

The default values are set to a temperature of 60°C and a humidity of 60%.

Press the „**Ⓜ**“, button to start the steam operation mode.

If you programmed the unit while it was running, you must switch off and restart it using the „**Ⓜ**“, button.



After starting up, the display alternates between the time of day, the preset humidity level and the remaining heating time.

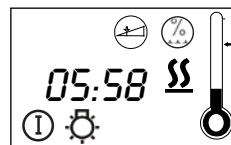
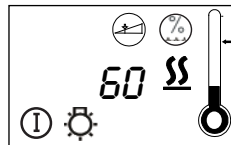

Once the heating cycle ends, the unit automatically starts the reheating program to dry out the cabin. The steam symbol disappears and the operation symbol  begins to blink.

The display now alternates between the time of day and the remaining reheating time. Once the reheating cycle is over, the control unit shuts down the system automatically.



Switching back to Finnish Operation

Press „MODE“ key.

Now press „▲“, key until **P3** is shown on the display.

Confirm with „Mode“ key

The humidity operation can be deactivated with the „▼“, button.

Please confirm with a long press on the „Mode“ button until the new value is flashing on the display.

Afterwards the displays shows „P3“ for short time.

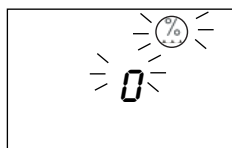
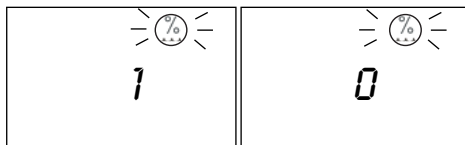
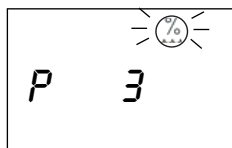

Switching during humidity operation

If you wish to switch to Finnish operation from steam operation, press the „▼“, and „▲“, buttons simultaneously. The unit now switches to Finnish operation with the preset temperature. The oven now heats in all three phases until the remaining heating time runs out, which can be seen by the  symbol. Again, the display alternates with the time of day.

Once the heating time is over, the unit shuts down the sauna system automatically.

In the case of re-start the unit is started in humidity operation using the parameters last set.



Attention:

The temperature selection of these mode: only in the Finnish operation.

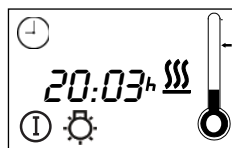



P4 Humidity setting

The humidity is set by the factory to a value of 60%

- if a humidity sensor is installed and activated the desired, relative air humidity is set in % (target value).
- if no humidity sensor is installed or it is deactivated the value set – and displayed – indicates a time pulse value (e.g. 80% = vaporiser is switched on for 4 minutes and off for 1 minutes)

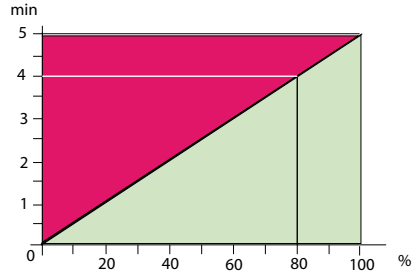

For humidity intensity adjustment please press „Mode“ button.

Afterwards the „▲“ button until in the display the humidity symbol and „P4“ appears.

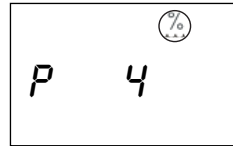

Please confirm with the „Mode“ button.

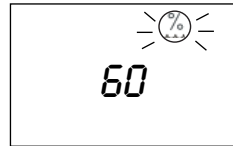

Please chose the wished value with the „▼“, and „▲“, buttons.

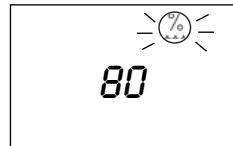

Please confirm with a long press on the „Mode“ button until the new value is flashing on the display.

Afterwards the displays shows „P4“ for short time. Humidity intensity is now fixed with the new value.

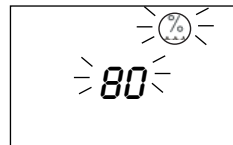

If you changed the setting during operation, the display now alternates between current time, remaining running time and the set humidity level.

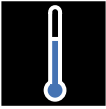

P5 Temperature setting



**Attention: Temperature range
in Finnish operation 30-110 C
in humidity operation 30-70 C**

The temperature is fixed on 95C for Finnish operation and 60C for Humidity operation.

For temperature adjustment please press „**Mode**“ button.

Afterwards the „**▲**“, button until in the display the heating symbol and „**P5**“ appears.



Please confirm with the „**Mode**“ button.

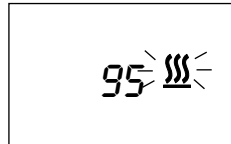

Please chose the wished value with the „**▼**“, and „**▲**“, buttons.

The arrow at the thermometer-symbol shows the selected temperature-area.

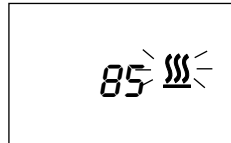

Please confirm with a long press on the „**Mode**“ button until the new value is flashing on the display.

Afterwards the displays shows „**P5**“ for short time. Temperature is now fixed with the new value.

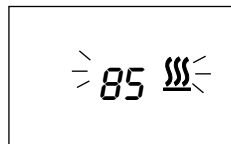



P6 Programming fan operation

This control unit gives you the option of switching on a fan (max. 100W) and setting the fan speed individually to one of 3 stages.

The default setting is „no fan mode“. Only in post heating operation after operation humidity the fan is default on the maximum step.

For fan function adjustment please press „**Mode**“ button.

Afterwards the „▲“, button until in the display the fan symbol and „**P6**“ appears.

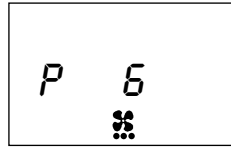

Please confirm with the „**Mode**“ button.

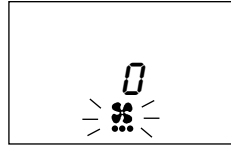

Please chose the wished value with the „▼“, and „▲“, buttons.

They mean:

0 = fan off

1 = fan level 1 (approx. 1/3 output)

2 = fan level 2 (approx. 2/3 output)

3 = maximum fan output

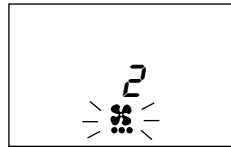

Please confirm with a long press on the „**Mode**“ button until the new value is flashing on the display.

Afterwards the displays shows „**P6**“ for short time. Fan function is now fixed with the new value.

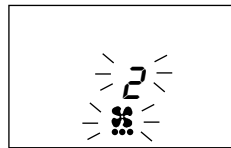

The selected level can be seen by the points under the fan icon on the screen.

Level 0 fan off

Level 1

Level 2

Level 3



P7 Ability to dim the cubicle lights

Please note that this function may only be programmed in combination with incandescent bulbs. **No phosphorous, energy-saving or gas discharge bulbs may be used.**

The default light setting is maximum. You can dim the cubicle lighting of your sauna as you wish.

For illumination power adjustment please press „**Mode**“ button.

Afterwards the „...“ button until in the display the light symbol and „**P7**“ appears.

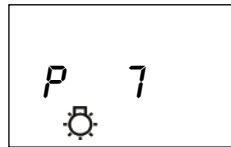

Please confirm with the „**Mode**“ button.

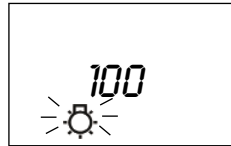

Please chose the wished value with the „▼“, and „▲“, buttons.

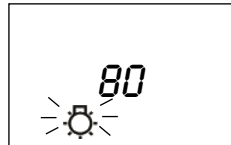

Please confirm with a long press on the „**Mode**“ button until the new value is flashing on the display.

Afterwards the displays shows „**P7**“ for short time. Illumination power is now fixed with the new value.

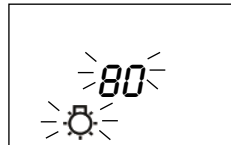



Coloured light (optional)



This programming option is only available if the coloured light module (item number 942761 / 944286 / 944834) has been installed.





Switch off all power to the system before installing the coloured light module.

You have the option of operating a coloured light device in your sauna using the HCS 9003 control unit. Each coloured light may not exceed the maximum power of 100 W.

Switching on the coloured light

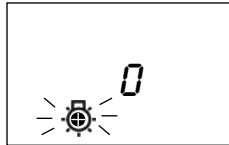
Press the „  „ button for approx. 5 seconds. The coloured light symbol and the number 0 appear on the display.



Please chose the wished value with the „  „, and „  „ buttons.

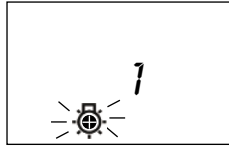

They mean:

	Art.No.: 94.2761	Art.No.: 94.4286	Art.No.: 94.4834
0	off		
1	automatic mode		permanent with
2	permanent red		
3	permanent yellow		
4	permanent green		
5	permanent blue		
6	permanent red yellow green blue:	automatic mode 1.min	
7	permanent yellow green blue	automatic mode 2.min	automatic mode 4.min
8	permanent red green blue	automatic mode 5.min	automatic mode
9	Sunrise		

When the coloured light is switched on the screen also displays the flashing coloured light icon.



The coloured light icon indicates the segment for the colour that is currently lit.

The colours are assigned as follows.

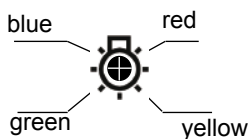

If coloured light mode is to be switched off use the previous instructions and set the value to „0“.

It goes without saying that the sauna lights can also be switched on and off in coloured light mode. To do so press the light switch as usual.

If the sauna light is on the coloured light icon does not flash but is shown constantly.

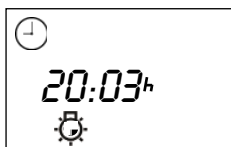



P9 Setting the time interval for the coloured light

This programming option gives you the option of automatically setting the length of time each colour is on. The default is one minute.

You can set on-time to between 1 and maximum 10 minutes..

For shining period adjustment please press „**Mode**“ button.

Afterwards the „▲“, button until in the display the colour light symbol and „**P9**“ appears.

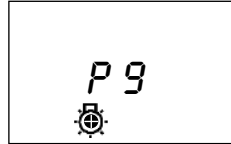

Please confirm with the „**Mode**“ button.

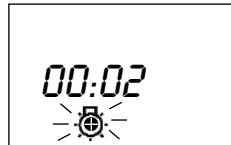

Please chose the wished value with the „▼“, and „▲“, buttons.

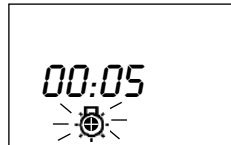

Please confirm with a long press on the „**Mode**“ button until the new value is flashing on the display.

Afterwards the displays shows „**P6**“ for short time. Shining period is now fixed with the new value.

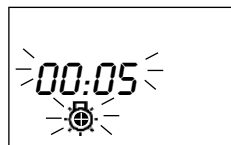

The control unit switch (Switch-off)

The control unit switch can be found on the top end of the unit. Using this switch, you can isolate the electronics from the mains supply in case of a breakdown.

In case of breakdown, press the control unit switch on the left part of the rocker to the first position (switch position 0). The unit is now completely switched off.

In order to switch on the light in the sauna when the unit is switched off, press on the left part of the rocker to the second position (switch position II).

In order to put the unit back into operation, switch back to the starting position (switch position I).

Control unit switch

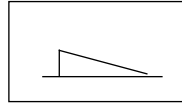

= unit switched on

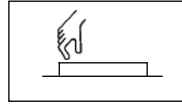

= unit switched off

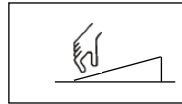

= light switched on

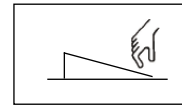

Switching over the heating time limitation for commercial use or weekly timer

Attention! Completely disconnect the control unit from the electrical circuit!

As a standard, the control unit is supplied with a heating time limitation of max. 6 hours.

To change over to max. 12 hours, there is a jumper socket on the bottom board. This is plugged in the factory with the “6h” marking. By changing to “12” or “24h”, the heating time can be set to max. 12 hours, max. 24 hours or (∞) infinitely. If the jumper is removed, the heating time is max. 6 hours. By plugging the jumper to “Res”, the weekly timer is activated.



The maximum heating time for private use is 6 hours. Resetting to 12 or more hours is permissible only for supervised (commercial) operation.

Jumper

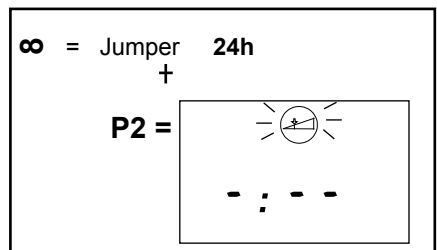
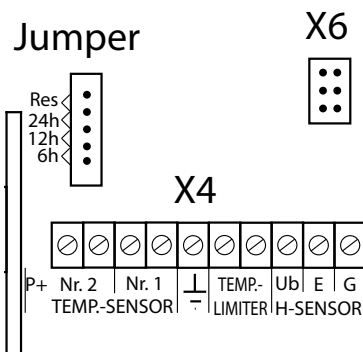

Error display

In order to provide an immediate diagnosis for any errors that may occur, the following errors can be determined via on-screen error codes.

Error code	Error
E 100	Temperature sensor paused
E 101	Temperature sensor short circuit
E 103	Interruption bench sensor
E 104	Short-circuit bench sensor
E 111	Humidity sensor paused
E 211	Excess temperature fuse paused
E 510	Lack of water – refill period
E 511	Lack of water – refill period exceeded

For each error code the  warning icon on the screen starts to flash so that it is easy to see that there is an error code.

To quit after notification of a lack of water (error message E511) press the Mode button and then immediately restart the device.

Other error options that are not displayed and their causes:

KScreen is blank – no background lighting

Check the main switch setting.

Check the mains connection! Each of the 3 phases L1, L2 and L3 must have 230V AC.

Check the fuses!

The temperature can not be set to over 70°C

Check whether the device is in Finnish mode. („P3=0“)

Cabin light malfunction:

Check the fuse on the main board

Fan malfunction:

Check the fuse on the main board

Both fuses are 500 mA T

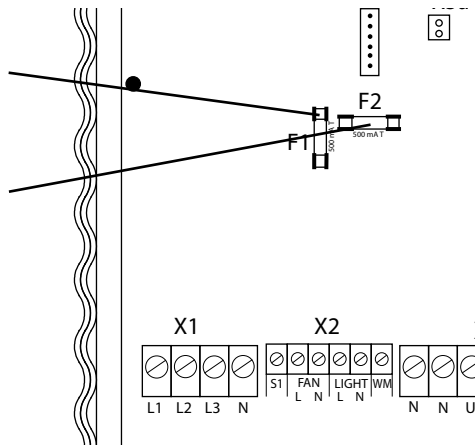

Please keep this address in a safe place together with the installation guide.

To help us answer your questions quickly and competently, please provide data printed on the ID plate, to include system type, article no. and serial no., in all inquiries.

Service Address:

EOS-WERKE GÜNTHER GmbH
Adolf-Weiß-Straße 43
35759 Driedorf-Mademühlen, Germany
Fon: +49 (0)2775 82-0
Fax: +49 (0)2775 82-431
servicecenter@eos-werke.de
www.eos-werke.de

Guarantee

The guarantee is taken over according to the legal regulations at present.

Manufacturer's warranty

- The period of warranty starts from the date of purchase and lasts up to 2 years for commercial use and 3 years for private use.

- Always include the completed warranty certificate when returning equipment.

- The warranty expires for appliances which have been modified without manufacturer's explicit agreement.

- Damages caused by incorrect operation or handling through non-authorized persons are not covered under the terms of warranty.

- In the event of a claim, please indicate the serial number as well as the article code number and type name with expressive description of the fault.

- This warranty covers damaged parts but no defects due to wear and tear.

In case of complaint please return the equipment in its original packaging or other suitable packaging (caution: danger of transport damage) to our service department.

Always include the completed warranty certificate when returning equipment.

Possible shipping costs arising from the transport to and from point of repair cannot be borne by us.

Outside of Germany please contact your specialist dealer in case of warranty claims. Direct warranty processing with our service department is in this case not possible.

Equipment start-up date:

Stamp and signature of the authorized electrician:

Handling procedures for return shipments (RMA) - Details for all returns !

Dear customer

we hope that you will rejoice in the ordered articles. Just in case that you are not entirely contented as an exception, please follow the procedures specified below. This enabling us to ensure a quick and smooth handling of the return shipment.

Please absolutely respect for all returns!

- Please add the available **RMA-voucher** always **completely filled out** together with an **invoice copy** to the return shipment! Do not stick it on the goods or on the packaging. **We do not accept the return shipment without these papers.**
- Not prepaid parcels **will be refused** and returned to Sender! Please always ask for the **RMA-No.** for the cheapest return.
- **Please pay attention that** the goods have to be sent back **without visible marks of use** in the **original scope of delivery and in original packing.**
- We recommend to use an **additional solid and break-proof covering box** which should be padded out with styrofoam, paper or similar. Transport damages as a result of faulty packing are for the sender's account.

Form of complaint:

1) Transport damage

- Please check the content of your parcel immediately and advise the forwarding company of a claim (parcel service/ freight forwarder)
- Do not use damaged goods!
- Ask the forwarder for a **written acknowledgement of the damages.**
- **Report the claim promptly by phone to your dealer.** He will discuss with you how to act in this case.
- If the transport box has been damaged, please use an additional covering box. Do not forget to add the **acknowledgement of the damage of the forwarding company !**

2) Faulty goods

- The implied warranty period is 2 years. Please contact your dealer in case of **faulty or wrong articles or missing accessories.** He will discuss with you the individual case and try for immediate and customer-friendly solution.
- For **economic returns** within Germany you will get an **RMA-number from the manufacturer.**
- All returns have to be in the **original packing of the goods with corresponding accessories.** Please repack the goods to avoid damages. In case of wrong delivery, please do not use this article !

3) Problems of installation and functioning

- Please **read the manual carefully first of all** and pay attention to the indicated assembly or installing instructions.
- **Your dealer should be the first contact person** because he knows his products best and also knows possible problems.
- **In case of function problems with an article,** please check at first whether there is an obvious material defect. The quality system in our factory reduces malfunctions of new appliances to almost zero.