

emotion of sauna.



EmoTouch II GF

for the installer



GB Assemblyinstruction

Made in Germany



Druck Nr. 29344222 en/ - 09.11

Table of Contents

Scope of Delivery	4
Optional connections:.....	4
Technical data.....	5
General Safety Regulations.....	6
Assembly	7
Power element.....	7
Connect the Control Line	7
Control element	9
Assembly.....	9
Laying the control line	9
Electrical connection.....	11
Connecting the sauna heater.....	11
Connecting the sauna lamp	12
Connecting a fan	12
Connecting a power control unit.....	12
Connecting a colored light.....	12
Connecting the remote button.....	12
Connecting a GSM module.....	12
Connecting a Loud speaker	12
Connecting a Sound - Modul.....	12
Connecting the phase section module for LED/spot lights.....	12
Connecting the switch module for energy-saving lamps.....	12
Installation diagram.....	13
Terminal arrangement on the circuit board.....	13
Sensor connection	14
Connection of the vaporizer	14
Connection of sauna heaters ≤ 9 kW	15
Connection of sauna heaters > 9 kW.....	15
Connecting the sensor lines.....	16
Mounting the oven sensor.....	16
Installing the optional bench sensor.....	17
Connecting the vaporizer	18
Fitting of the humidity sensor (optional)	18

Operation / basic settings	19
Connecting for the first time	19
Call up the installer/operator menu	21
Locking	22
Deactivate bench sensor	22
Humidity sensor	23
Brightness of display	23
Link color light options with heater	23
The Help-Menu	24
The technology menu	25
Hysteresis	26
Fans	26
Switching from Finnish heater to climate heater or vice-versa	27
Refilling the water shortage	27
Reheating time	28
Reheating temperature	28
Sauna time	28
Service - interval	28
The Help-Menu	30
Error Message	31
Other error possibilities without display and their causes	32
Switching over the heating time limitation for commercial use or weekly timer	32
The Switch-off	33
Service Address:	34
Guarantee	34
Handling procedures for return shipments (RMA) - Details for all returns !	35

Scope of Delivery

(subject to changes)

1. Power switchgear
2. Control unit with protective housing
3. Control line ca. 2 m
4. Circuit board for heater sensor with over-temperature protection, KTY-sensor and sensor housing, two mounting screws 3 x 25 mm and sensor cable ca. 2,0 m long, white and red.
5. PE-bag with 7 mounting screws 4 x 20 mm.
6. Spare over-temperature protection
7. 4 cable ties
8. Drill template
9. 4 plastic dowels

Optional connections:



Bench sensor

Art. No: 94.4389



Humidity sensor

Art. No: 90.9479



Colored light module

Art. No: 94.2761



Neon colored light module

Art. No: 94.4286



EmoLux - colored light module

Art.No.: 94.4834



Sound - Modul

Art.No.: 94.4833



Loud speaker

Art. No: 94.4649



Remote start button

Art.No: 94.4645

Connection line 10m

Art.No: 94.4646

Connection line 25m

Art.No: 94.4647

Connection line 50m

Art.No: 94.4648



GSM mobile phone remote switch modul Art.No: 94.4671



Phase angle control
module for LED-/Halogen spotlights

Art.No: 94.4970



Control module for energie-saving
(fluorescent) lamps

Art.No: 94.4669

Technical data



Nominal voltage:	400 V 3 N AC 50 cycles
Switching capacity:	max. 9 kW ohmic load (AC1-operation)
Climate operation:	6 kW + 3 kW for evaporator unit, upgradable by connecting power switchgears
Limitation of heating time:	6 hrs, 12 hrs or no limitation of heating time
Display:	Touch-display
Type of protection:	IPx4 acc. DIN 40050 weatherproof protection
Control range sauna operation:	30 to 110 °C
Control range humidity operation:	30 to 70 °C
Humidity control:	with optional humidity sensor, otherwise time-proportional vaporizer control
Sensor system:	KTY-sensor with safety-temperature limiter 142 °C
Bench sensor:	optional
Water level control:	Inadequate amount of water in the vaporizer will lead to automatic cutoff
Control characteristics:	Digital two-step control
Ventilator performance:	min. 25W max. 100 W max 500 mA (only for fan without startup condenser)
Light:	min. 25W max. 100W max. 500 mA (ohmic load only)



Protection for light and fan may be realized with max. 500 mA slow-blow fuse. Fire hazard with higher protection.

Color light (optional):	max. 100 W per color
Reheating:	0-60 min. after disconnecting the humidity program
Error display:	with a warning triangle (blinking) and error code at the touch display
Ambient temperatures:	-10 °C to +35 °C
Storage temperatures:	-20 °C to +60 °C

General Safety Regulations

-  Caution! The unit may not be installed in closed cabinets or in an enclosed timber cladding!
- The electrical installation may only be performed by an authorized electrician.
- You must comply with the regulations of your utility company as well as the standard VDE-guidelines (DIN VDE 0100).
-  Caution! Danger of life: Never perform repair work and installations yourself. The housing cover may only be removed by a specialist.
- It is mandatory to follow the initiatives listed in the installation instructions, in particular when installing the temperature sensor. The temperatures above the heater are decisive for setting the temperature. The temperature limit values are maintained only when correctly installed and ensure very little temperature fluctuation in the bench area of the sauna cabin.
- The unit may only be used for the intended purpose to control sauna heaters up to 9 kW (in combination with power switchgear up to 36 kW).
- The system must be unplugged from the network before repair work or installations are performed, e.g. disconnect fuses or master switch.
- Follow the safety and installation information provided by the sauna manufacturer.
- Follow the information and instructions provided by the cabin manufacturer as well.
- Only use light bulbs for the cabin lighting. Never use fluorescent lamps, low-energy light bulbs or gas discharge lamps.
- In badly ventilated rooms a fan may be used additionally to remove the used up humid air.



Always make sure that the sauna heater is free from objects. Fire hazard!



Caution!

Dear customer,

In compliance with the valid regulations, the electrical connection of the sauna heater as well as the sauna control may only be performed by a certified electrician.

Therefore, this information is provided to you in case a copy of the invoice from the certified electrician must be presented for warranty claims.

Assembly

Power element

The power switchgear may only be installed outside the cabin. It is advisable to select the outside wall of the cabin or the cabin ceiling for the installation. If ductwork is provided for the electrical installations then the position of the power switchgear is predetermined by that. Please follow the instructions for installation:

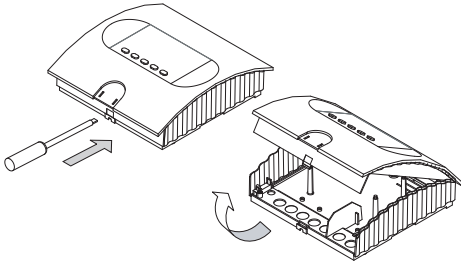

Fig. 1

1. Remove the cover of the power element by pushing the retaining tang to the inside with a flat screwdriver and pull the housing top upwards in a swinging fashion (Fig. 1).

The 5 mm diameter boreholes for the supplied wood screws 4 x 20 mm are drilled according to the dimensions shown in Fig. 3.

2. Insert one of the wood screws into the top center hole. The power element is hooked onto this screw. Therefore, leave the screw out by ca. 3 mm (Fig. 4).
3. Hook the power element to the 3 mm protruding screw in the upper mounting hole.

Insert the supplied rubber grommet into the openings at the rear wall of the housing and insert the connecting cable through these openings.

Connect the Control Line

A 2 m long control line to connect power element and control unit are provided in the delivery scope.



Fig. 2

This line must be inserted into the power unit first. To do that, position the red part of the line on the same colored contact strip in the power unit.

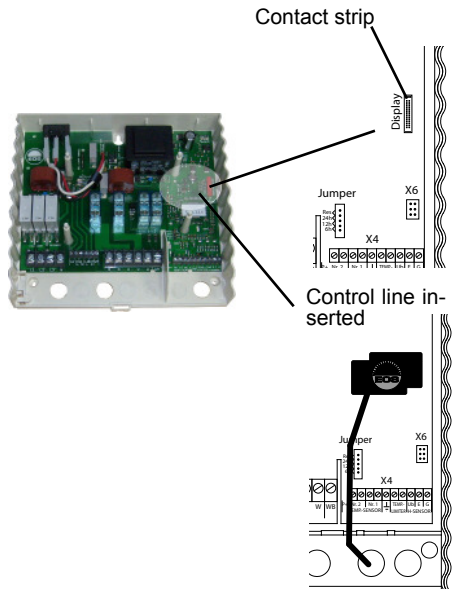
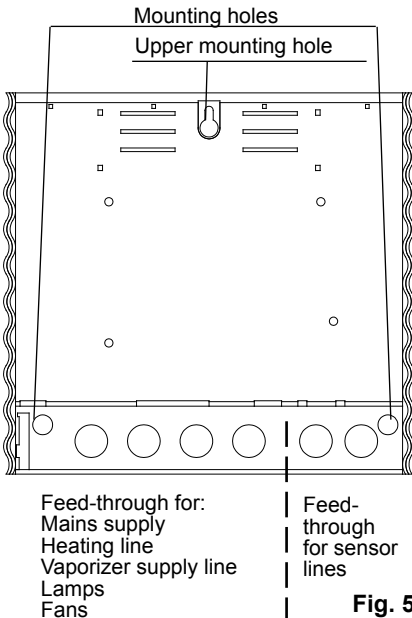
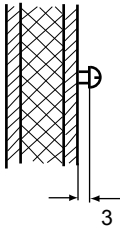
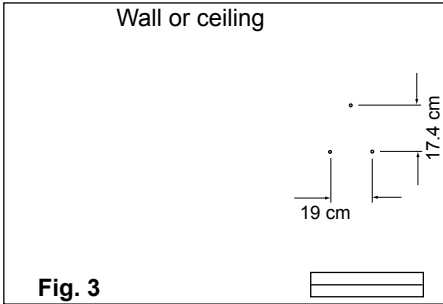

Fig. 2a

The control line is now inserted through the right cable feed-through and run up to the installation site of the control element.

Fasten the bottom section of the housing firmly to the cabin wall or cabin ceiling by inserting the screws into the bottom lower boreholes (Fig. 5).



Control element

Assembly

The control element may only be mounted outside the cabin. It is advisable to select the outside wall of the cabin. If ductwork is already provided for electrical installations then the position of the control element is predetermined by that. The installation is done into the cabin wall. Please follow the instructions for installation:

Define the exact installation site. Pay attention to the sizes shown in Fig. 6.

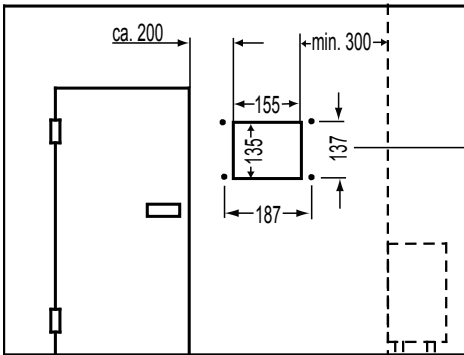

Fig. 6



Make sure that there are no lines or construction parts of the cabin that could be damaged in the installation area.

Use the supplied drill template (Print No. 2934 3846) to produce the wall cutout and the four holes with a diameter of 14 mm.

Attach the drill template to the cabin wall and cut out or drill out the wall openings. Pay close attention to the dimensional accuracy, especially for the four 14 mm diameter holes to accommodate the dowels.

Laying the control line

The control line may only be laid between the insulation and the outside wall of the cabin (Fig. 7).

(The insulation must be designed for max. outside temperature of 75 °C.)

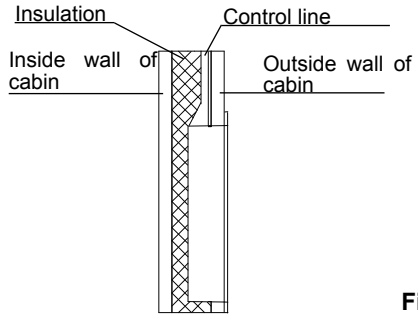

Fig. 7

Now lead the control line through the opening of the protective housing.

Plug the plug on the control line into the socket on the power element (Figs. 8 and 8a) until it automatically locks into place. It is now secured against unintentional loosening.

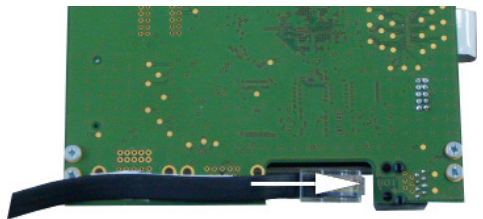

Fig. 8

If the plug has to be removed again then it must be unlocked as shown in Fig. 8a.

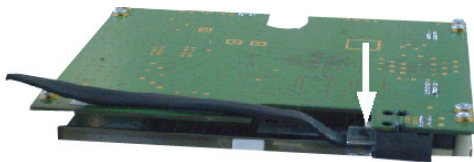

Fig. 8a

Finally, push the 4 dowels into the bore holes as shown in Fig. 9, then push the mounting pins of the control element into the dowels.

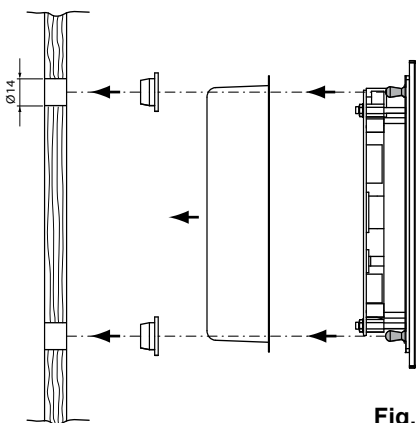

Fig. 9

Electrical connection

The electrical connection may only be done by a certified electrician in compliance with the guidelines of the local utility company and the VDE.

In general, there may be only one fixed connection to the network; therefore equipment should be provided that makes it possible to disconnect the system with all poles from the network with a contact opening width of minimum 3 mm.

All electrical installations and all connection lines that are installed inside the cabin must be suitable for ambient temperature of at least 170 °C.

The power supply line is run to the load control unit and connected to the power input terminals.



Connecting the sauna heater

Install the sauna heater and the vaporizer in front of the air intake according to the manufacturer's installation instructions.

Run the silicone line through the ductwork to the power unit and connect it to the appropriate terminals as directed in the wiring diagram.

Note: In case there is no ductwork available drill a hole next to the air intake opening and run the heater line through this hole to the outside and to the appropriate terminals in the control unit. The silicone line must be buried to protect it from outside influences. Therefore, use a suitable cable-duct or a PVC-pipe through which you can run the line up to the power unit.



Connecting the sauna lamp

The sauna lamp must be weatherproof protected (IPx4) and resistant to the ambient temperature.

The sauna lamp can be mounted at any point, but never near to rising hot air from the heater and as far as possible from the installation position of the IR lamp (may not in the direct beam).



Connecting the remote button

Details can be found in the remote button assembly instructions.



Connecting a GSM module

Details can be found in the GSM module assembly instructions.



Connecting a fan

The fan must be weatherproof protected (IPx4) and resistant to the ambient temperature.

The fan can be mounted at any point, but never near to rising hot air from the heater and as far as possible from the installation position of the IR lamp (may not in the direct beam).



Connecting a Loud speaker

Details can be found in the loud speaker assembly instructions.



Connecting a Sound - Modul

Details can be found in the Sound - module assembly instructions.



Connecting a power control unit

Details can be found in the power control unit assembly instructions.



Connecting the phase section module for LED/spot lights

Details can be found in the switch module assembly instructions.



Connecting a colored light

Details can be found in the colored light assembly instructions.



Connecting the switch module for energy-saving lamps

Details can be found in the switch module assembly instructions.

Installation diagram

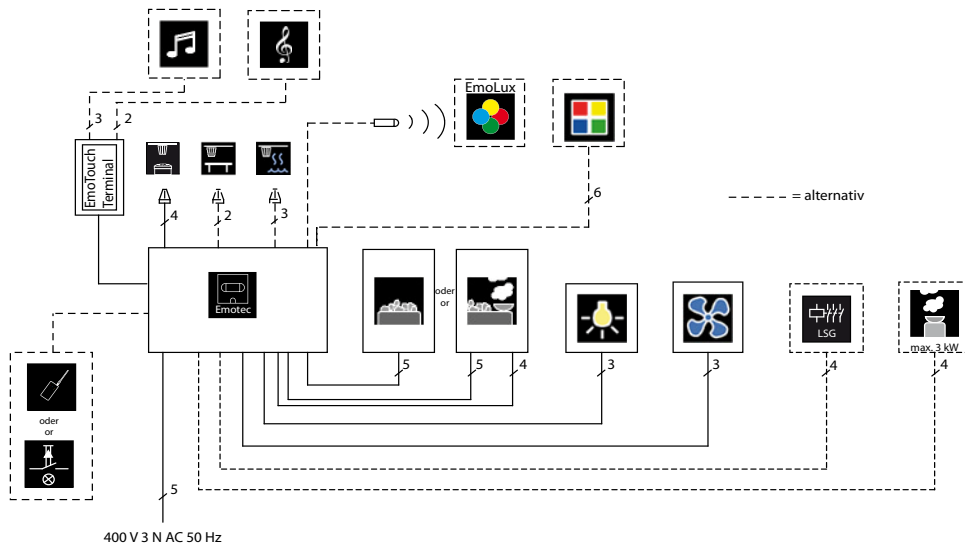

Terminal arrangement on the circuit board. (Power unit)

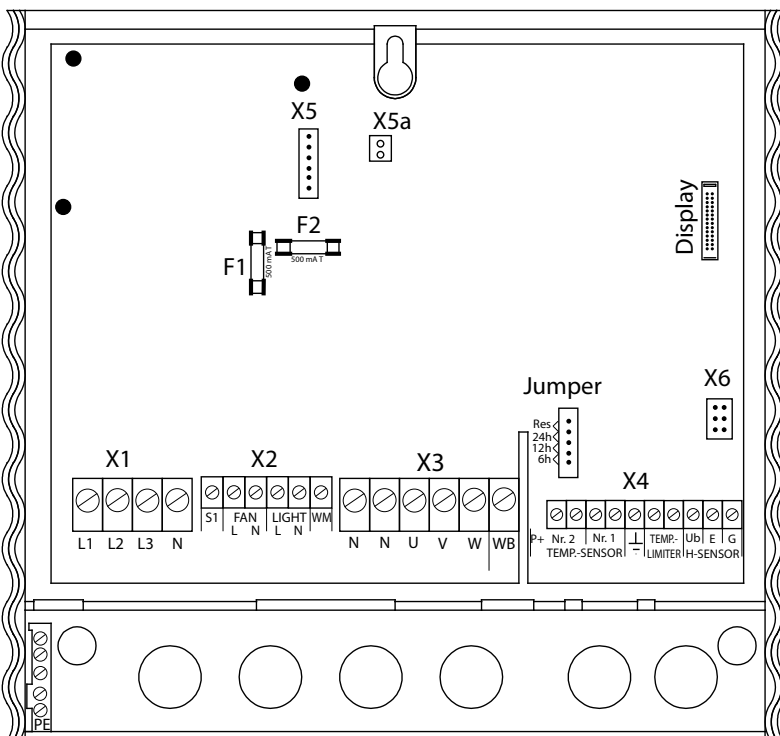

Sensor connection

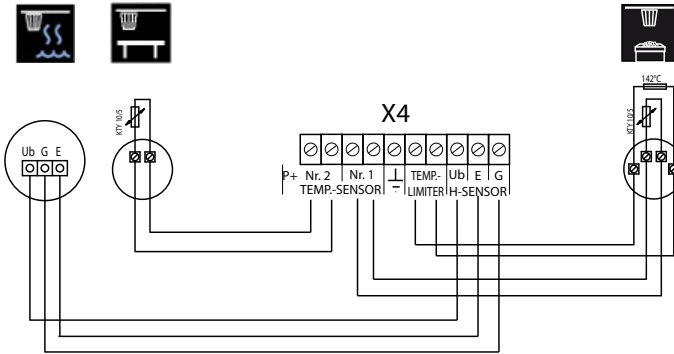

Connection of the vaporizer

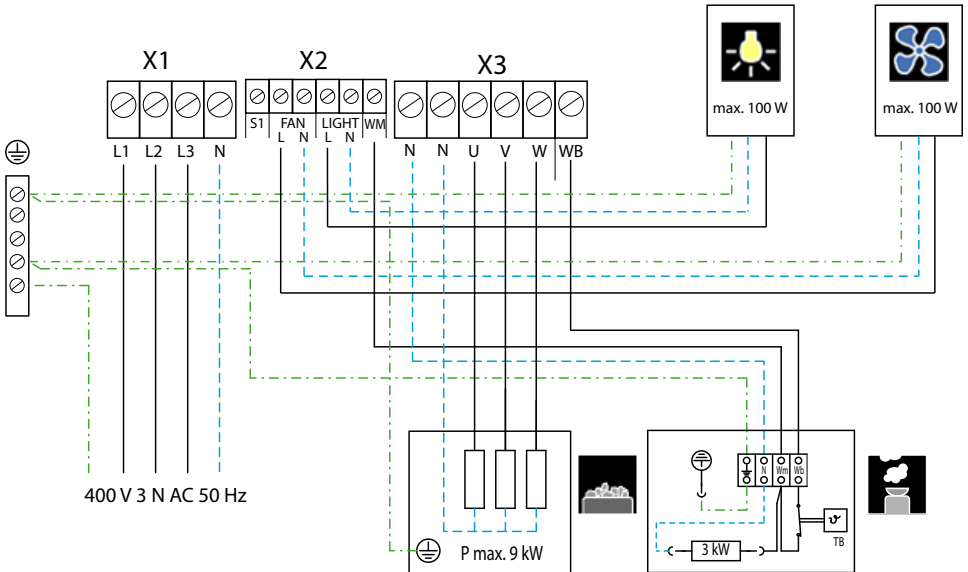

CAUTION

When connecting the vaporizer the output “W” is switched from the sauna heater to the terminal “Wb” to the vaporizer.

In this case, the sauna heater heats only with two thirds of the power.

Connection of sauna heaters ≤ 9 kW

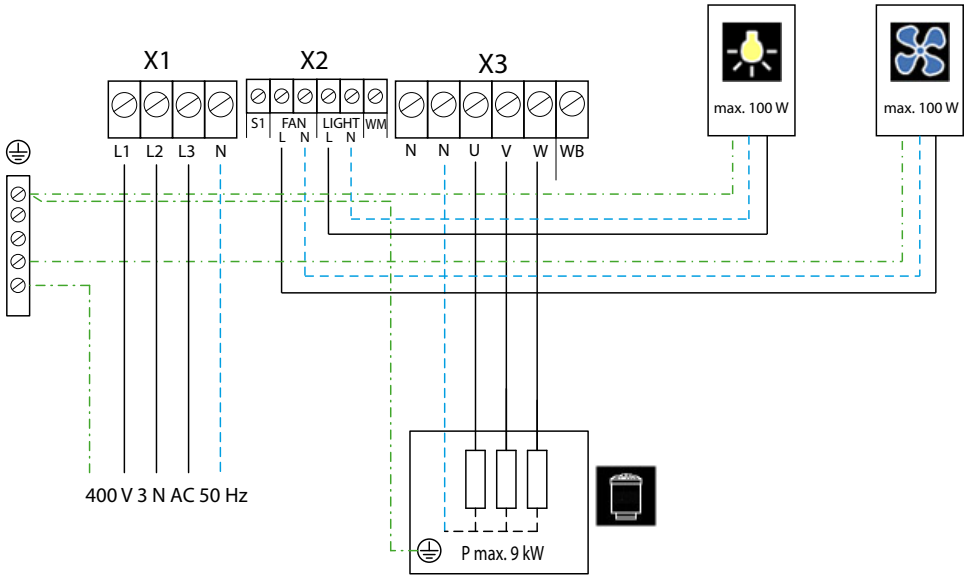

Connection of sauna heaters > 9 kW

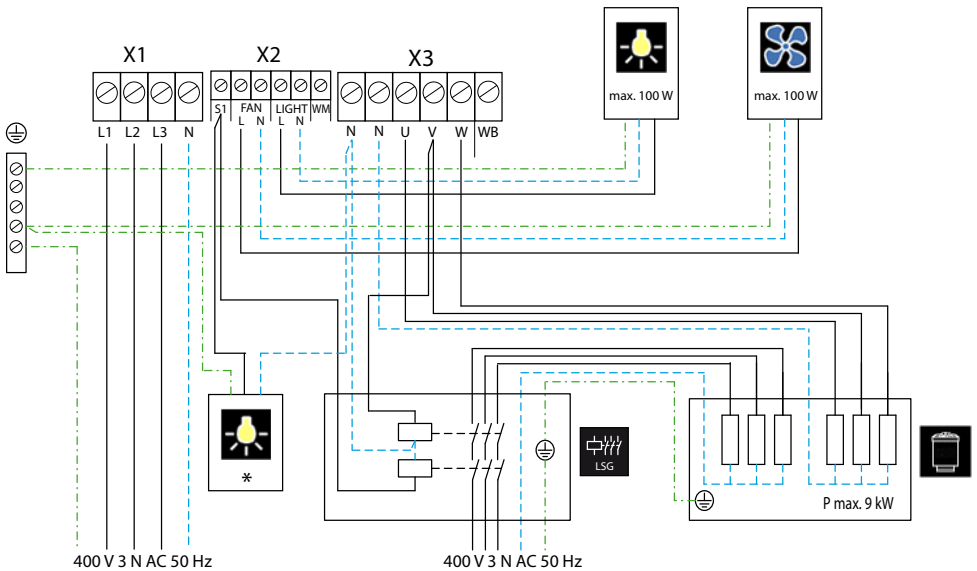

* For public installations without heating time limitation, the pilot light must be installed in the control room.

Connecting the sensor lines

You should not install sensor and power supply lines together, or lead them through the same conduit. This can lead to interferences in the electronics, such as „fluttering“ in the relays. If it is absolutely necessary to install them together, or the wire is longer than 3m, you should use a shielded sensor line such as the LIYLY-O x 0.5 mm²). Connect the shielding to mass in the control unit.

Please note that the following measurements are based on values provided by the unit quality assurance by the European Standard EN 60335-2-53. In principle, you must mount the oven sensor where temperatures are expected to be the highest. Illust. 7 gives you an overview of the mounting point of the sensor.



Mounting the oven sensor

1. Mount the oven sensor in cabins up to 2 x 2m according to Illust. 7 and 8, in larger cabins according to Illust. 7 and 9.

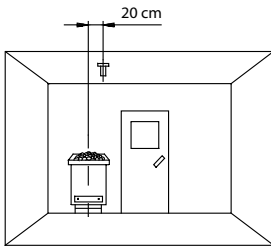

Illust. 7

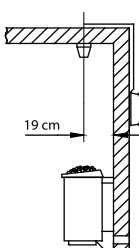

Illust. 8

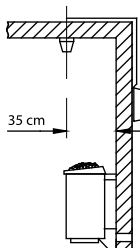

Illust. 9

2. Drill a hole to lead the cable through, preferably through the middle of one of the wooden boards.
3. Lead the sensor cable through the drilled hole and attach it to the sensor line according to Illust. 10.
4. Attach the lines for the shutoff (white) and the temperature sensor (red) according to Illust. 11 to the sensor board. Then insert the sensor board into the housing.
5. After you are finished installing and have made sure the control unit is functioning properly, check the line for overheat shutoff protection for short circuits. To do this, release one of the white lines in the sensor housing. The safety relay of the control unit should now fall; i.e. the heating circuit should now be interrupted.

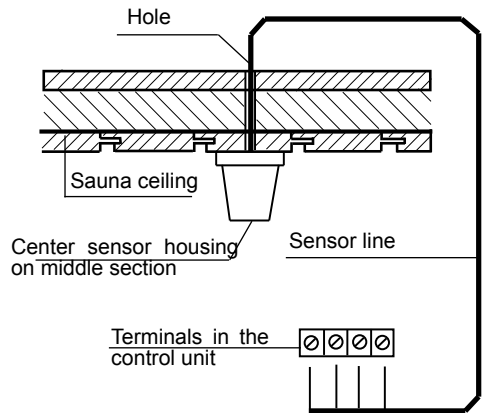

Illust. 10

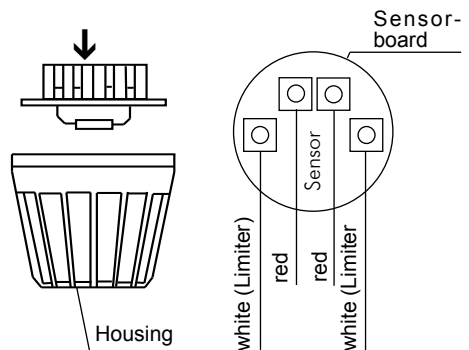

Illust. 11



Installing the optional bench sensor

Installation location: The bench sensor is fixed to the ceiling of the rear reclining bench as described for the installation of the heater sensor.

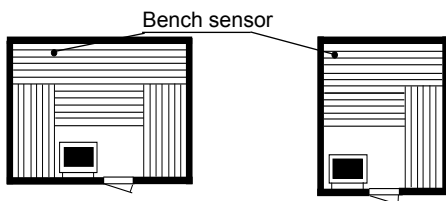

The bench sensor is connected via a 2-wire silicone cable on the control unit to the terminals on the right-hand side of the lower board. The terminals are marked „Temp.-Sensor Nr. 2“.

If there is a problem with the bench sensor, a fault message will appear:

E 103 = Interruption bench sensor

or

E 104 = Short-circuit bench sensor

In this case, the sensor must be checked by an expert and replaced if necessary. At room temperature, the sensor has approx. 2 kΩ.

After disassembly the sensor can be deactivated so that you can use your sauna despite the problem. See the ‚Bench sensor‘ chapter for more details.

Once the problem has been solved, the control unit recognises the sensor once the mains voltage has been switched on again.

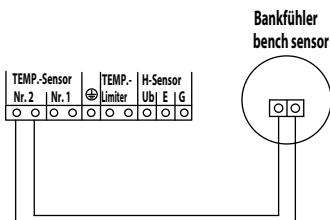

When the sensor is connected correctly, the control unit automatically recognises the sensor once the mains voltage has been switched on again..



Connecting the vaporizer

To connect the vaporizer, use silicon connecting lines 4 x 1,5 mm² as well.



Warning: When connecting the vaporizer make sure it is correctly attached to the water bath (WB) and low water shutoff (WM). If you switch these connections, you disable the water deficiency function and bypass the thermostat. As a result, the vaporizer will overheat.

This is a fire hazard!!

Illust. 6 shows the circuit diagram. The control unit can detect water deficit if there is a zero-potential feed at the WM-input.

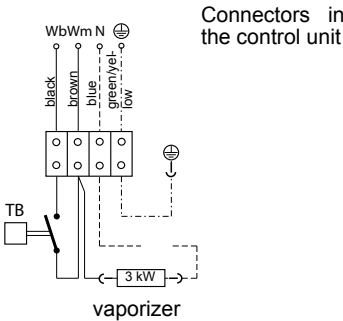

Illust. 6



Fitting of the humidity sensor (optional)

1. The humidity sensor is fitted in the centre of the sidewall facing away from the oven at a height of approximately 150 cm.
2. See illust. 12 for the connection sequence of the strands.
3. Ensure the connection is exactly correct—incorrect connections can lead to defects in the sensor.

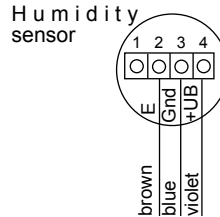

Illust. 12

The sensors are connected to the clamps at the lower right outer edge of the control unit in accordance with the following scheme.

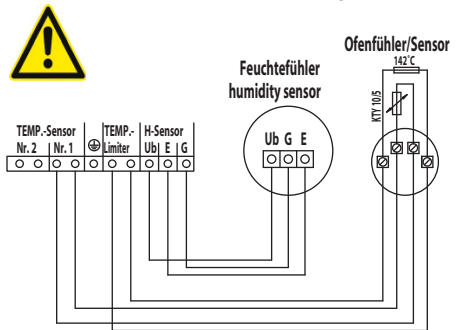

Warning: Always connect the neutral conductor of the sauna oven. During steam operation, one phase of the oven is shut down; therefore the heating load is no longer symmetrical. The result is that the neutral wire is no longer current-free.

Programmed maximum values EN 60335-2-53:2003

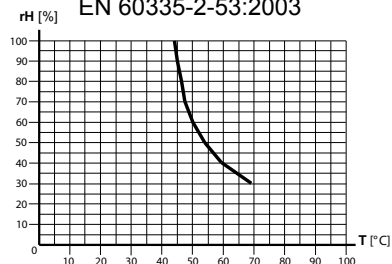



Operation / basic settings

You operate your electronic control unit with touch screen and intuitive user interface for sauna and sauna with humidity operation by touching the displayed symbols or buttons on the display.

The respective function is turned on by briefly touching the respective image section.

When touching the respective image section for longer than 3 seconds the unit switches to the set mode.

The adjustable value is shown in green or with a green border. By touching the surface  /  or the respective buttons the setting is changed. The changed setting will then be shown in red or with a red border. Afterwards touch the  area to save the new setting. The display or border of the new setting changes from red to green.

If you do not change the setting within 15 seconds the unit automatically changes back to the original state.

Connecting for the first time

Once the installation is completed, turn the power on.

Depending on the length of storage of the unit the EOS-Logo appears briefly

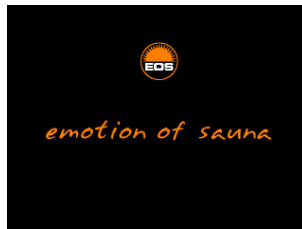

and the unit switches to standby mode,

or you are prompted by the display to make a few basic adjustments.

First, set the current time with  / .

When confirmed with  the display changes to the next screen.

Here you set the type of sauna heater that you wish to operate:



= sauna heater without vaporizer (Finnish operation)



= sauna heater with vaporizer (Finnish and climate operation)

The operation of a sauna heater is factory set with vaporizer, identified with the green border around the symbol.

If you wish to operate a sauna heater without vaporizer, touch the  button and the symbol is framed in red.

Then save the entry with . The red border changes to green.

You have now completed the basic settings.

Setting the time may be changed by the end consumer at a later time.

Changing the setting of the type of sauna heater is a job for the installer.

The EOS-logo briefly appears and the unit switches to standby mode.

The enclosed operating instructions (Print No. 29343840) show you how to operate the unit.

In addition to the “additional settings” described in the operating instructions, you as installer have additional options that should not be changed during the operation.

These settings can only be called up after entering the code number.

There is a differentiation between 2 types of settings here.

- Operator menu (settings are performed by a janitor, pool staff etc.)
- Technology menu (settings should be kept for a service technician)

Any changes made here may lead to faults or malfunction of the control; therefore do not hand these instructions (and especially the code numbers) to the end user of the system.

Call up the installer / operator menu

Touch the  symbol on the bottom right-hand side for ca. 3 seconds; the unit changes to the installer menu.

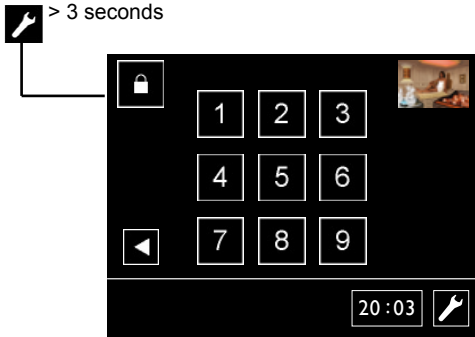

Call up the installer/operator menu

In the operator menu you can activate/deactivate the components or set the values which should only be changed by instructed personnel (janitor, pool staff) in normal use of the sauna.

Enter the code

483

in order to enter the operator menu.

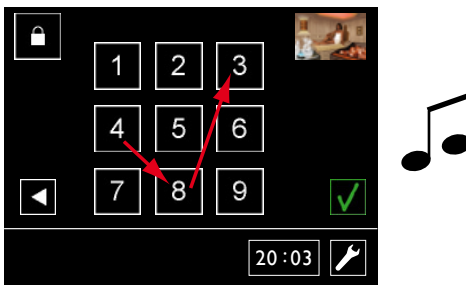

If correctly entered, an acoustic signal sounds.

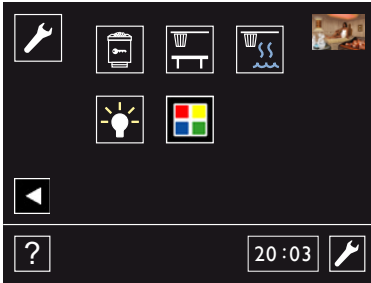

Confirm the entry by touching the green tick.

The following displays appear:



Locking

Select by:

- Select from the operator menu .
- Select help  from the menu.



All setting options can be blocked (e.g. for hotel or commercial operations) with this function.

The user can only switch the lighting and sauna on and off.



Unlocked



Locked

Deactivate bench sensor



This option is shown only when a bench sensor is installed and when this bench sensor is interrupted (error message "E103").

It serves the purpose of being able to use the unit with a bench sensor e.g. until a new bench sensor can be installed.

To deactivate the bench sensor, disconnect the connection line in the control unit and perform the following setting in the installer - menu.





The bench sensor symbol is no longer displayed

Once you have properly installed a functioning bench sensor at a later date the unit automatically detects the unit when connected and activates the bench sensor. The symbol will then no longer be displayed in the installer - menu.

Humidity sensor

Select by:

- Select from the operator menu .
- Select help  from the menu.





Humidity sensor deactivated



Humidity sensor activated



Brightness of display

Select by:

- Select from the operator menu .
- Select help  from the menu.





You may adjust the brightness of the display to the individual situation or desires.

 /  30 - 100% 

Link color light options with heater

Select by:

- Select from the operator menu .
- Select help  from the menu.



This setting option is only available if an optionally connectable color light module (Art. No: 94.2761 / 94.4286) is installed.



The color light function is linked with the heater function.
i.e. the color light automatically turns on if the heater is initialized.



The color light function is not linked with the heater function



The Help-Menu

By touching the **?** button in the “Operator Menu” display you will get to the Help Menu.

First, select the desired language.

All relevant and changeable parameters are shown and its functions described briefly. Depending on the unit design, some parameters may not be available and are therefore not shown. By touching the respective symbols you will go directly to the desired setting option.

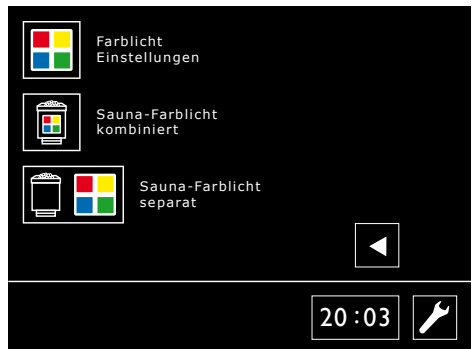
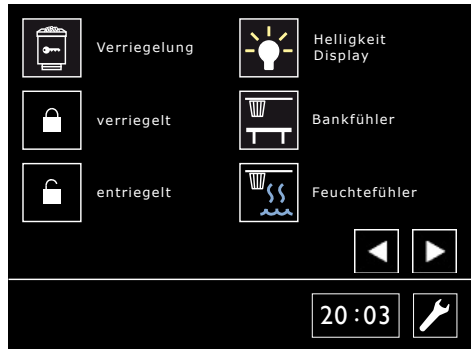

The technology menu

In the technology menu you can activate/deactivate the components or set the values which should only be changed by a service technician in normal use of the sauna.

Enter the code

2486

in order to enter the technology menu.

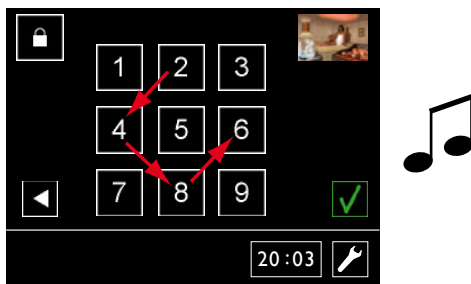

If correctly entered, an acoustic signal sounds.

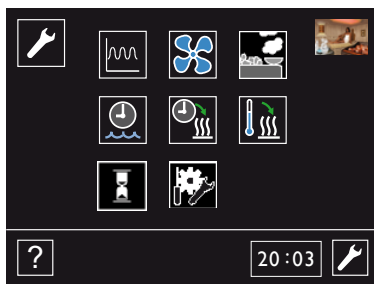

Confirm the entry by touching the green tick.

The following displays appear:





Hysteresis

Select by:

- Select from the technology menu .
- Select help  from the menu.





The switch hysteresis defines the temperature difference between disconnect at target-temperature and reconnect for reheating when cooled off in °C. Factory set to 5 °C.

 /  1 - 10 

Fans

Select by:

- Select from the technology menu .
- Select help  from the menu.



Fan off



1/3 power





2/3 power



Full power

Switching from Finnish heater to climate heater or vice-versa

Select by:

- Select from the technology menu .
- Select help  from the menu.



During the first general settings you chose the heater type used. If a different heater than the one selected was installed, the control is adjusted here.



Finnish heater (heater without vaporizer)





Climate heater (heater with vaporizer)

Do not mix up this setting with the various adjustable operating modes when operating a climate heater. It refers solely to the heater type connected.

Refilling the water shortage

Select by:

- Select from the technology menu .
- Select help  from the menu.





When your heater reports water shortage you will have the time preset here (for safety reasons maximum 5 minutes) to refill the water.

Be careful. The unit parts may be hot and heavy steam may occur. **!!!Danger of scalding!!!**

When the water shortage alarm lasts longer than the set period your control unit turns off the entire sauna unit.

The following error message will appear on the display: "E511".

Read Chapter Error Messages to find out how you can restart your unit.



 /  00:01 - 00:05 h 

Reheating



After turning off the humidity operation the heater operates to the “reheating temperature” for the duration of the “reheating time” for the final drying time.

Reheating time

Select by:



- Select from the technology menu .
- Select help  from the menu.





 /  00:00 - 1:00 h 

Reheating temperature

Select by:



- Select from the technology menu .
- Select help  from the menu.



 /  70 - 110° C 

Sauna time

Select by:

- Select from the technology menu .
- Select help  from the menu.



The sauna time function is deactivated





The sauna time function is activated



Service - interval

This menu can be used to set the number of hours after which the unit should provide a service reminder.

Select by:

- Select from the technology menu .
- Select help  from the menu.



 /  0 - 2500 h 

The setting takes place in 250 h stages - no reminder is set with the 0 h setting.

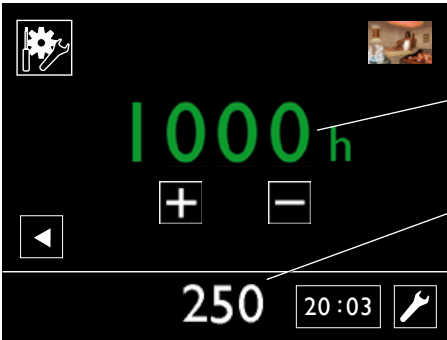

Service interval time

Remaining time until next service.

If the number is negative, the number of hours exceeding the service time is displayed.

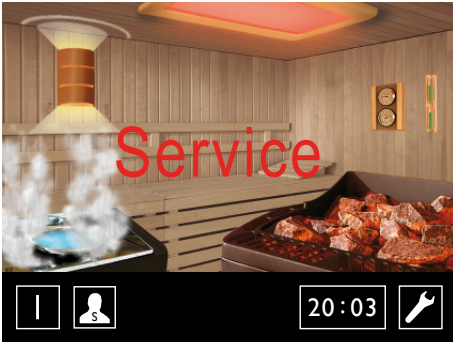

If the set service interval time is exceeded, the word "service" flashes in red on the display for approximately 15 seconds when the unit is switched on.

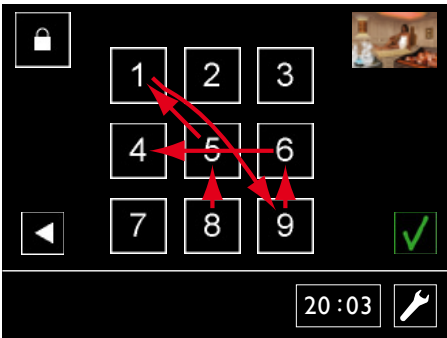

In order to reset the operating hours to the set value, press the  symbol for 3 seconds and enter the code

851964



The Help-Menu

By touching the  button in the “Technology Menu” display you will get to the Help Menu.

First, select the desired language.

All relevant and changeable parameters are shown and its functions described briefly. Depending on the unit design, some parameters may not be available and are therefore not shown. By touching the respective symbols you will go directly to the desired setting option.

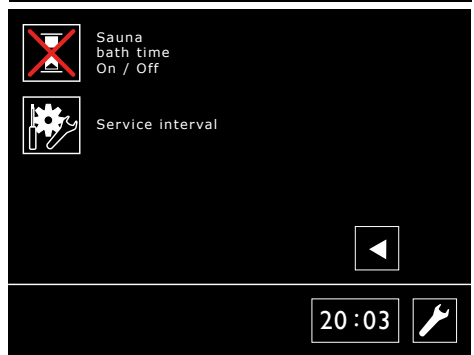
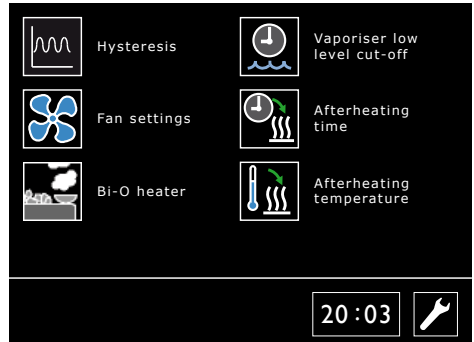

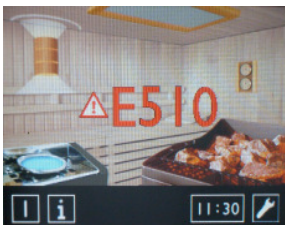

Error Message

In order to show you an immediate diagnosis when a possible error occurs, the following errors may be defined on the display through the error code.

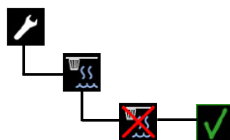

Error code	Error	Remedy
E 100	Interruption temperature sensor	Check the lines or sensors. The respective sensor has approx. 1.9 kΩ at 20° room temperature. Exchange the sensor if necessary.
E 101	Short-circuit temperature sensor	Please contact your dealer.
E 103	Interruption bench sensor	
E 104	Short in bench sensor	Check lines, replace sensor if necessary.
E 111	Interruption or short in humidity sensor	To be able to use your sauna you may deactivate the humidity sensor. To do that touch the following buttons:



	ty sensor	Check lines or thermal fuse. Thermal fuse = 142°C
E 211	Interruption in over-temperature protection	Refill water
E 510	Water shortage – refill period	To acknowledge the error report after water shortage fill water into vaporizer first. Be careful. The unit parts may be hot and heavy steam may occur. !!!Danger of scalding!!!
E 511	Water shortage – refill period exceeded	By touching the  symbol for ca. 3 seconds you will start the unit again.

Other error possibilities without display and their causes

No display on the display - no background lighting

Check the switch position on the unit switch.

Check the mains connection! 230 V AC must be applied to all 3 phases L1, L2 and L3.

Check the fuses!

Cabinet light does not work:

Check the miniature fuse on the plate

Fan does not work:

Check the miniature fuse on the plate.

Both fuses are 500 mA T miniature fuses.

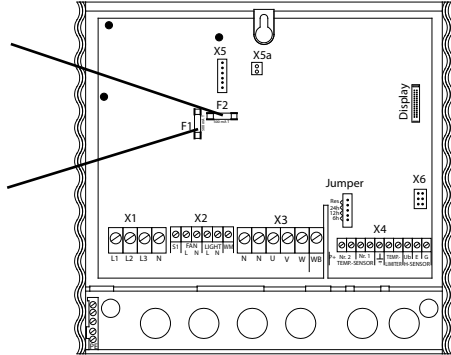

Switching over the heating time limitation for commercial use or weekly timer

Attention! Completely disconnect the control unit from the electrical circuit!

As a standard, the control unit is supplied with a heating time limitation of max. 6 hours.

To change over to max. 12 hours, there is a jumper socket on the bottom board. This is plugged in the factory with the “6h” marking. By changing to “12” or “24h”, the heating time can be set to max. 12 hours, max. 24 hours or (∞) infinitely. If the jumper is removed, the heating time is max. 6 hours. By plugging the jumper to “Res”, the weekly timer is activated.



For private use, the maximum heating time is 6 hours. An extension to 12 or more hours is only permitted with supervision (commercial use).

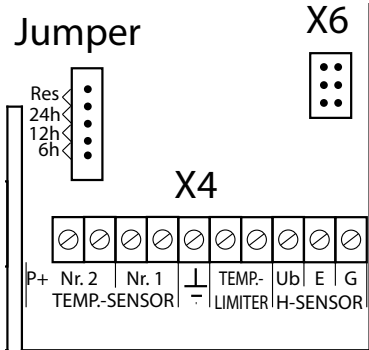

30 minutes - 12 / 24 hours

Jumper to 12 h / 24 h

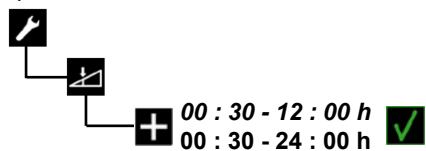

Without heating time limitation
jumper to 24 h

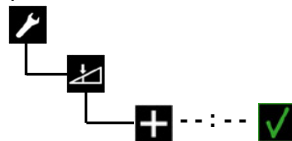

The Switch-off

You will find the unit switch on the top side of the power control unit. You can disconnect the electronics from the mains using this switch in case of a fault.

In case of faults push the unit switch on the left side of the rocker to the first latch (switch setting 0). The unit is now completely switched off.

To turn the light on in the cabin with disconnected unit push the left part of the rocker to the second latch (switch setting II).

To make the unit ready for operation, switch back to the initial position (switch setting I).

Switch-off

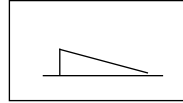

= unit is turned on

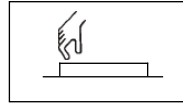

= unit is turned off



= light is turned on

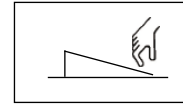

Please keep this address in a safe place together with the installation guide.

To help us answer your questions quickly and competently, please provide data printed on the ID plate, to include system type, article no. and serial no., in all inquiries.

Service Address:

EOS-WERKE GÜNTHER GmbH
Adolf-Weiß-Straße 43
35759 Driedorf-Mademühlen, Germany
Fon: +49 (0)2775 82-0
Fax: +49 (0)2775 82-431
servicecenter@eos-werke.de
www.eos-werke.de

Guarantee

The guarantee is taken over according to the legal regulations at present.

Manufacturer's warranty

- The period of warranty starts from the date of purchase and lasts up to 2 years for commercial use and 3 years for private use.

- Always include the completed warranty certificate when returning equipment.

- The warranty expires for appliances which have been modified without manufacturer's explicit agreement.

- Damages caused by incorrect operation or handling through non-authorized persons are not covered under the terms of warranty.

- In the event of a claim, please indicate the serial number as well as the article code number and type name with expressive description of the fault.

- This warranty covers damaged parts but no defects due to wear and tear.

In case of complaint please return the equipment in its original packaging or other suitable packaging (caution: danger of transport damage) to our service department.

Always include the completed warranty certificate when returning equipment.

Possible shipping costs arising from the transport to and from point of repair cannot be borne by us.

Outside of Germany please contact your specialist dealer in case of warranty claims. Direct warranty processing with our service department is in this case not possible.

Equipment start-up date:

Stamp and signature of the authorized electrician:

Handling procedures for return shipments (RMA) - Details for all returns !

Dear customer

we hope that you will rejoice in the ordered articles. Just in case that you are not entirely contented as an exception, please follow the procedures specified below. This enabling us to ensure a quick and smooth handling of the return shipment.

Please absolutely respect for all returns!

- Please add the available **RMA-voucher** always **completely filled out** together with an **invoice copy** to the return shipment! Do not stick it on the goods or on the packaging. **We do not accept the return shipment without these papers.**
- Not prepaid parcels **will be refused** and returned to Sender! Please always ask for the **RMA-No.** for the cheapest return.
- **Please pay attention that** the goods have to be sent back **without visible marks of use** in the **original scope of delivery and in original packing.**
- We recommend to use an **additional solid and break-proof covering box** which should be padded out with styrofoam, paper or similar. Transport damages as a result of faulty packing are for the sender's account.

Form of complaint:

1) Transport damage

- Please check the content of your parcel immediately and advise the forwarding company of a claim (parcel service/ freight forwarder)
- Do not use damaged goods!
- Ask the forwarder **for a written acknowledgement of the damages.**
- **Report the claim promptly by phone to your dealer.** He will discuss with you how to act in this case.
- If the transport box has been damaged, please use an additional covering box. Do not forget to add the **acknowledgement of the damage of the forwarding company !**

2) Faulty goods

- The implied warranty period is 2 years. Please contact your dealer in case of **faulty or wrong articles or missing accessories.** He will discuss with you the individual case and try for immediate and customer-friendly solution.
- For **economic returns** within Germany you will get an **RMA-number from the manufacturer.**
- All returns have to be in the **original packing of the goods with corresponding accessories.** Please repack the goods to avoid damages. In case of wrong delivery, please do not use this article !

3) Problems of installation and functioning

- Please **read the manual carefully first of all** and pay attention to the indicated assembly or installing instructions.
- **Your dealer should be the first contact person** because he knows his products best and also knows possible problems.
- **In case of function problems with an article,** please check at first whether there is an obvious material defect. The quality system in our factory reduces malfunctions of new appliances to almost zero.