

emotion of sauna.

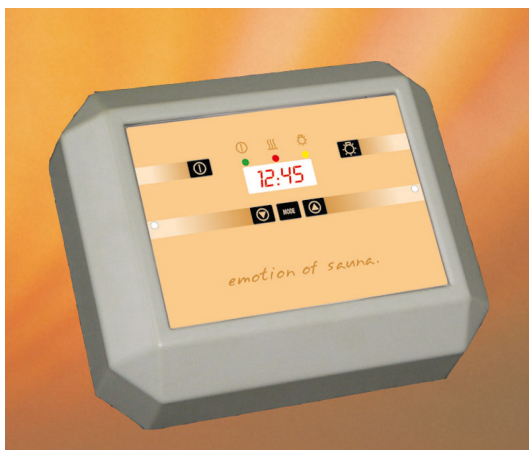

ECON 45A2



GB Assembly and operating instruction

Made in Germany



IP x4

Druck Nr. 29343787en 01.10

Table of Contents

Package contents	3
General information concerning sauna bathing	4
General safety precautions	5
Assembly of the control unit.....	6
Wall mounting.....	6
Electrical connection	7
Connecting the sauna oven	8
Connecting the sauna lamp	8
Connecting the sensor lines.....	9
Mounting the oven sensor.....	9
Operation	10
Switching on the control unit for the first time	11
Using the sauna	11
Finnish sauna operation.....	11
Switch off the sauna.....	11
Switching the light on and off.....	12
Changing the preset parameters	12
Changing the temperature	12
Starting with set time.....	13
Deactivating the preset time.....	14
Changing the current time.....	15
Extended heating time	16
(commercial use)	16
The control unit switch (Switch-off).....	16
Troubleshooting / error messages	17
Connection diagram.....	17
Service Address:.....	18
Guarantee.....	18
Handling procedures for return shipments (RMA) - Details for all returns !.....	19

Package contents

(subject to change)

Included with the control unit are

1. an oven-sensor board with overheat shutoff protection, KTY-sensors with sensor housing, two 3x25 mm fastening screws and a 1,7 m long sensor cable.
2. a plastic bag with three 4 x 20 mm fastening screws.
3. a replacement overheat protection module

Technical data

Rated voltage:	400 V 3 N 50 Hz AC
Breaking capacity:	max 9 kW resistive load (AC 1 operation) upgrade to 36 kW possible through connection to circuit breakers
Heating time shut-off:	Heating time limit: 6 h, 12 h
Display:	two-digit, 7 segmented display
Protection type:	IPx4 in accordance with DIN (German Standards Institution) 40050, Splashproofing
Control range, sauna operation:	40 to 115° C
Sensor system:	KTY sensor with safety temperature limiter 142°C
Type of regulation:	Digital two-point control
Light:	max. 200 W max. 1A
Environmental temperature	-10°C bis +40°C
Storage temperatures:	-20°C bis +70°C

General information concerning sauna bathing

Dear customer,

with purchase of this sauna control unit you opted for a superior quality, high-tech electronic device which was developed and manufactured according to the highest standards and guidelines.

Please note that an optimal interaction of sauna cabin, sauna oven and sauna control unit is mandatory for a pleasant sauna climate in your cabin.

With this superior sauna control unit you can „operate“ your sauna system, and thanks to the many individual programming settings you will surely soon find the setting that suits you best.

Perception in the sauna is very subjective, therefore it really requires your own perception, or that of your family to find the most suitable settings.

By default the finnish sauna is preset to 95°C. For steam operation the values are set to 60°C and 60% humidity.

The following operation instructions describe how to pre-select „your“ climate in the cabin. Read these instructions carefully, so that you quickly and easily find your way through the programming process.

Please note the variation in temperatures in the cabin while sauna bathing. The hottest area is directly under the cabin ceiling, whereas there is a steady temperature gradient towards the floor of the cabin. Inversely, the relative humidity is lowest directly under the cabin ceiling and the highest on the cabin floor.

For safety reasons the temperature sensor with the overheat safety shutdown is located on the cabin ceiling above the oven, since this is the hottest area in the cabin.

Therefore there will always be temperature variations between the temperature sensor of the control unit and the thermometer in the cabin.

For the cabin light use only light bulbs. Do not use fluorescent lamps, energy saving lamps and gas discharge lamps.

For example, when pre-setting the cabin temperature to 100°C, the thermometer inside the cabin may easily show 85°C - 90°C. This complies with the typical climate inside the cabin.

Always observe hygiene. Always use hand- or bathing towels, to avoid getting perspiration on the wood.

To protect your cabin from possible damages due to steam operation, we recommend reheating or drying the cabin after every steam bath.



In addition, a fan can help to dissipate used humid air in badly ventilated areas.

To avoid the perception of draft, you should avoid using any ventilation system while sauna bathing. It should only be used if recommended by the cabin manufacturer



Always make sure no objects are located on the sauna oven before starting the heating cycle.

General safety precautions

- his device has not been designed for being used by persons (including children) that are physically or mentally handicapped or have sensory disabilities. Moreover, it is not allowed to use this device without sufficient experience and/or knowledge, unless these persons will be supervised by persons responsible for their security or in case they have been instructed how to use this device.
- Children are to be supervised in order to make sure that they do not play with this device.
-  Attention: It is forbidden to install the control box in a closed switch cabinet or behind a wooden panelling!
- The electrical installation may be done only by a qualified electrical technician.
- You must comply with the regulations of your power supply company and applicable VDE regulations (DIN VDE 0100).
-  **WARNING:** Never attempt repairs or installations yourself, as this could result in serious injury or death. Only a qualified technician may remove the housing cover.
- Please note the dimensions in the assembly instructions, especially when installing the temperature sensor. The temperature above the oven is critical for the temperature setting. The temperature can be held within operating parameters and a minimal temperature gradient inside the bench area of the sauna cabin can be achieved only if unit is assembled correctly.
- The device may only be used as intended as a control unit for sauna ovens up to 9 kW. (Up to 36 kW when combined with a breaking capacitor).
- Completely disconnect the control unit from the electrical circuit, i.e. flip all circuit breakers or the main circuit breaker during each installation or repair.
- Please note the safety and installation information from the sauna oven manufacturer.
- Always heed the specifications and instructions of the cabin manufacturer, too.



Attention!

Dear customer,

according to the valid regulations, the electrical connection of the sauna heater and the control box has to be carried out through the specialist of an authorized electric shop

We would like to mention to the fact that in case of a warranty claim, you are kindly requested to present a copy of the invoice of the executive electric shop.

Assembly of the control unit

Wall mounting

Mount the control unit outside the sauna cabin only. The most practical mounting point would be the wall area onto which the sauna oven is mounted on the inside, except on the outside of the cabin. If electrical conduits are present, mount the control unit accordingly. To mount the control unit, please follow these instructions:

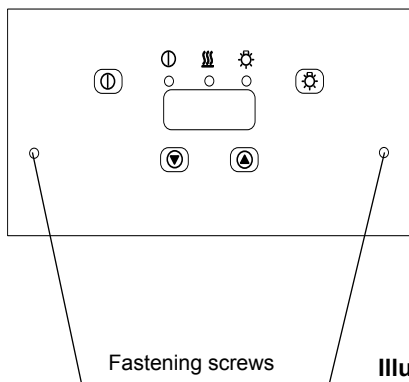

Illust. 1

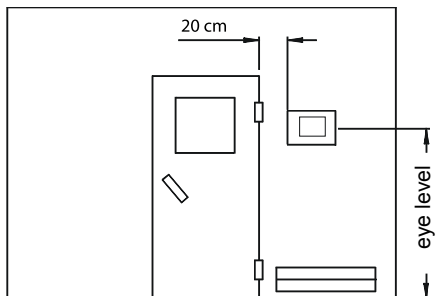

Illust. 3

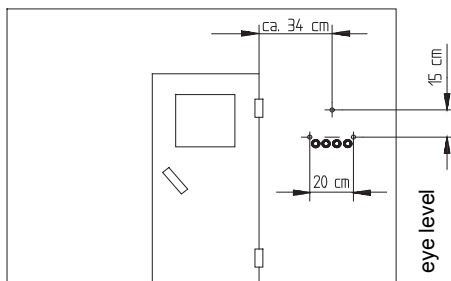

Illust. 3.1

1. Remove the cover of the control unit. Loosen the fastening screws below the control panel. If your unit uses control knobs, remove them. Enlarge the holes for the electrical cables (Illust. 4) with a sharp knife. Drill the threaded holes for the included 4 x 20 mm wood screws according to Illust.s 3 & 3.1.

2. Insert one of the wood screws into the upper middle hole. This screw will be the mounting point for the control unit. Make sure the screw is projecting out about 3 mm. (Illust. 3.2)

3. Hang the control unit onto the 3 mm projecting screw. Lead the electrical cable through the holes you enlarged in step 1 and screw the lower part of the housing onto the cabin wall using the lower threaded holes. (Illust. 4)

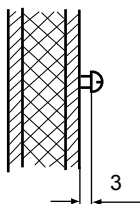

Illust. 3.2

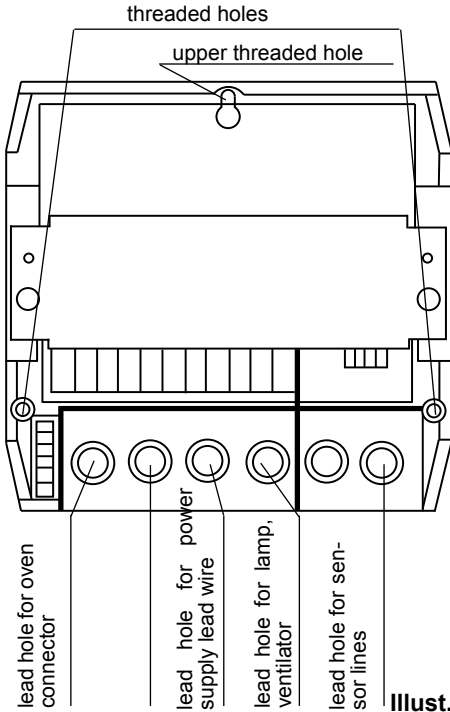

Illust. 4

Electrical connection



The electrical connection can only be carried out by an approved electrician, observing the local energy supply company's guidelines and those of the VDE (German Electrical Association). We should advise you at this point that in the case of a warranty claim, a copy of the invoice from the electrical company who carried out the work will be required.

In general, there can only be one permanent connection to the power supply network, to include a device which allows the unit to be disconnected from the power source with a contact distance of at least 3 mm from all terminals.

All electrical installations and connector cables inside the cabin must be able to withstand temperatures up to 170°C. Please use the table below to determine the required cable diameters for this task.

Attach the power supply lead wire as shown in Illust. 5 to the power supply terminals of the control unit. Connection instructions are printed directly in the control unit.

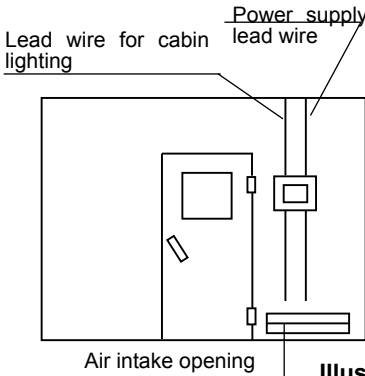

Illust. 5

Tab. 1

Capacity acc. DIN	Electrical. Connection	Fuse control unit in A	For cabin size	Connecting cable main - control unit in mm ²	Connecting cable control unit - heater in mm ²
4,5 kW	3N AC 50 Hz 400 V	3 x 16	4 - 6 m ³	5 x 2,5	5 x 1,5
6,0 kW			6 - 10 m ³		
7,5 kW			8 - 12 m ³		
9,0 kW			10 - 14 m ³		

All cross sections of a line are minimum diameters in mm² (Copper line)

Connecting the sauna oven



Warning: Always connect the sauna oven's neutral conductor.

Assemble the sauna oven and the vaporizer according to the instructions provided by the manufacturer in front of the air intake opening. Lead the silicon lines and electrical conduits to their respective terminals on the control unit and connect them according to the circuit diagram printed there.

Please note: If no electrical conduits are present, drill a hole with a diameter of 10 mm next to the air intake opening and lead the oven control cables through this hole to their corresponding terminals (U V W) in the control unit. To protect the silicon lines from external influences, install them in a shielded fashion. For this task, use a fitting cable or simple PVC conduit and lead the silicon cable through it to the control unit

Connecting the sauna lamp

The sauna lamp must be splashproof (by Standard IP54) and suitable for temperatures up to 142°C. The sauna lamp can be mounted anywhere except in the area of the rising hot air above the oven.

Connecting the sensor lines

You should not install sensor and power supply lines together, or lead them through the same conduit. This can lead to interferences in the electronics, such as „fluttering“ in the relays. If it is absolutely necessary to install them together, or the wire is longer than 3m, you should use a shielded sensor line such as the LIYLY-O x 0.5 mm²). Connect the shielding to mass in the control unit.

Please note that the following measurements are based on values provided by the unit quality assurance by the European Standard EN 60335-2-53. In principle, you must mount the oven sensor where temperatures are expected to be the highest. Illust. 7 gives you an overview of the mounting point of the sensor..

Mounting the oven sensor

1. Mount the oven sensor in cabins up to 2 x 2m according to Illust. 7 and 8, in larger cabins according to Illust. 7 and 9.

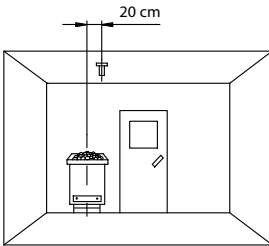

Illust. 7

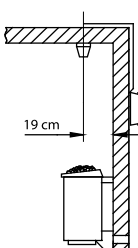

Illust. 8

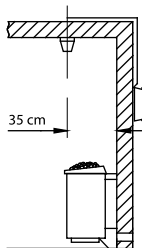

Illust. 9

2. Drill a hole to lead the cable through, preferably through the middle of one of the wooden boards.
3. Lead the sensor cable through the drilled hole and attach it to the sensor line according to Illust. 10.
4. Attach the lines for the shutoff (white) and the temperature sensor (red) according to Illust. 11 to the sensor board. Then insert the sensor board into the housing.
5. After you are finished installing and have made sure the control unit is functioning properly, check the line for overheat shutoff protection for short circuits. To do this, release one of the white lines in the sensor housing. The safety relay of the control unit should now fall; i.e. the heating circuit should now be interrupted.

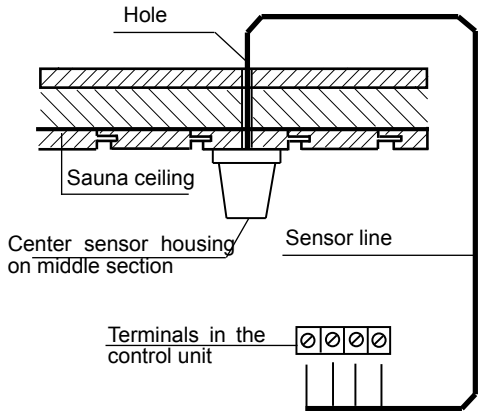

Illust. 10

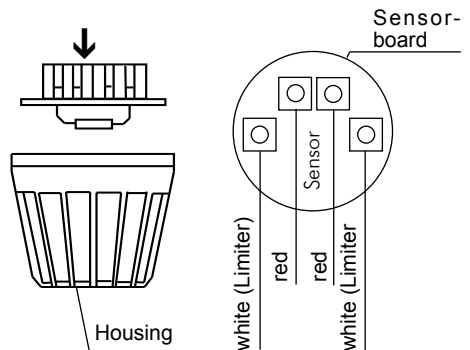

Illust. 11

On the pages that follow, we would like to familiarise you with the operations and features of your sauna control system. In each case the illustrations next to the text show the displays visible on the control unit. The symbol ≍ means that the relevant part of the display is flashing. Before long we trust that you will be in a position to make full use of your sauna's control system.

We hope you enjoy plenty of time relaxing in your sauna.

Operation

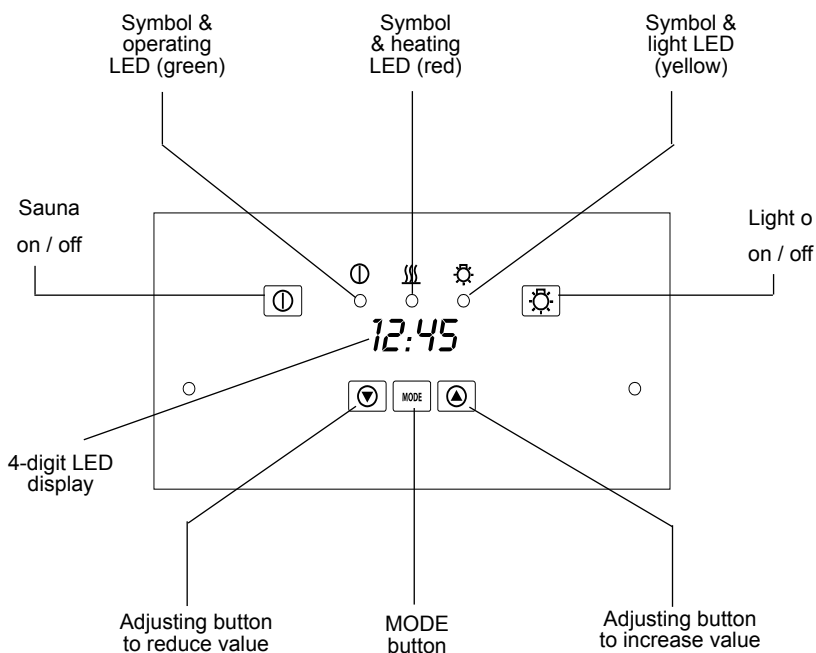

If the control box does not pick off voltage after closure, please check the position of the control box switch (Switch-Off). See chapter about „control box switch (Switch-Off)“ at the end of this manual.

Switching on the control unit for the first time

After making a final check on all the connections – **ensure that the control unit switch is set to I** – connect the unit to the mains by switching on the fuses or the main switch.

After switching on the time flashes.



Using the ▼ and ▲ buttons, you can now set the correct time.



To save the time, press the „MODE“ button and hold it down until the time is permanently displayed

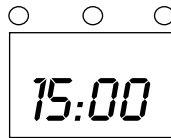

Using the sauna

Finnish sauna operation

Press the ① button to switch on the sauna heater. The display alternately shows the current time and the set temperature (factory setting 95° C). The green operating LED comes on and as long as the sauna heater is on, the red heating LED is also displayed.



Switch off the sauna

At expiration of the heating time delimitation the plant switches off automatically. If you want to switch the plant off manually, press the ① - button. When switching off the control reacts mode of operation-dependently.

The plant is switched off. In the announcement the current time appears



Switching the light on and off

By pressing the  button, the sauna room lighting can be switched on or off. The yellow light LED is also illuminated on the display when the lighting is switched on.

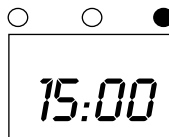

Changing the preset parameters





In order to change the preset parameters for temperature the sauna must be switched off.



If no input is made for more than 10 secs. during programming, the unit automatically switches back to its resting state without saving the modified values

Changing the temperature

In the following one we show, how you can stop the temperature of the Sauna your desires accordingly. Please take into consideration that these values can vary by a few degrees, depending on cabin configuration. For safety reasons the temperature is measured in the hottest area of the cabin above the oven. This temperature serves as a value for the temperature around the sauna benches. Depending on oven capacity and placement of the fresh air vents, undesirable influences can alter these measurements, not allowing the maximum temperature to be reached. The control range is laid out so that normal temperatures in the bench area can be preselected.

Press the  or  button until the set temperature is displayed.

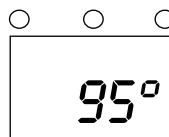

Press the „**MODE**“ button. The display starts to flash

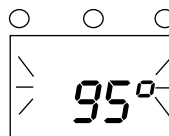

Using the  and  buttons, you can now set the desired temperature.

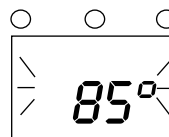

You now have two options.

Option 1:

If you want to use the sauna right away.

Press the ⓘ button..

The set temperature is saved, the sauna switches on and is regulated to the new set temperature.

Option 2:

If you want to use the sauna later.

To save the new set temperature, press the „MODE“ button and hold it down until the newly entered value is permanently displayed.

You can now set other parameters.

If you do not carry out other settings the unit switches back to its resting state after 10 seconds.

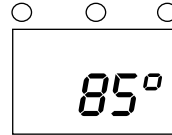

Starting with set time

Using the set time function, you can select the time that your sauna heater switches on up to 24 hours ahead.



Always ensure at this point that there are no objects on top of the sauna heater when the heating cycle starts. Fire risk!

Press the ▼ or ▲ button until the set set time is displayed.

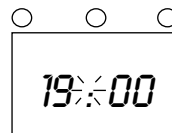

The set time display can always be recognised by the flashing colon.

Press the „**MODE**“ button. The display starts to flash.

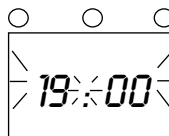

Using the ▼ and ▲ buttons, you can now set the desired set time.

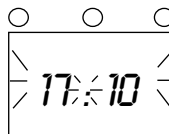

Please consider that the cubicle must heat up for around 40-50 minutes to achieve an appropriate temperature. If, for example, you want to start your sauna at 18.00 select the preset time to 17.10.

To save the new set time, press the „**MODE**“ button and hold it down until the newly entered value is permanently displayed.

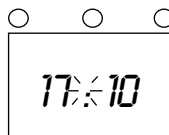

To activate the preset time, press the ⓘ button. The display shows the current time and the preset time alternately. When the preset time arrives, the sauna heater switches itself on.

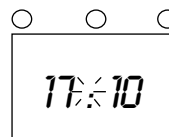
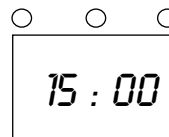

Deactivating the preset time

To deactivate the preset time, press the ⓘ button. This switches the sauna heater on. Pressing the ⓘ button again switches the sauna heater off.

Changing the current time

(to switch between **summer and winter time** for example)

Press the ▼ or ▲ button until the set time is displayed.

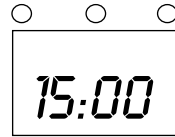

Press the „MODE“ button. The display starts to flash



Using the ▼ and ▲ buttons, you can now set the correct time.

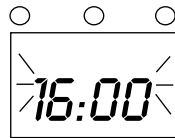

To save the time, press the „MODE“ button and hold it down until the time is permanently displayed



Extended heating time

(commercial use)

Attention! Completely disconnect the control unit from the electrical circuit!

In its delivery condition the control unit is set to a maximum heating period of 6 hours. The heating time limit can be extended to 12 hours.

To do this, the jumper is plugged in according to the illustration opposite.

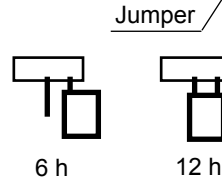
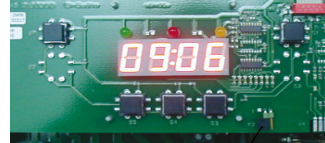

For the private sector, the maximum heating time is 6 hours. Extending this time to 12 hours is only allowed when operated under supervision (commercial use).

The control unit switch (Switch-off)

The control unit switch can be found on the top end of the unit. Using this

switch, you can isolate the electronics from the mains supply in case of a breakdown. Please note that operating the control unit switch returns all settings to the factory settings.

In case of breakdown, press the control unit switch on the left part of the rocker to the first position (switch position 0). The unit is now completely switched off.

In order to switch on the light in the sauna when the unit is switched off, press on the left part of the rocker to the second position (switch position II).

In order to put the unit back into operation, switch back to the starting position (switch position I).

Control unit switch

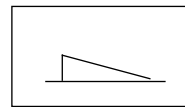

= unit switched on

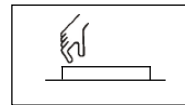

= unit switched off

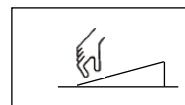

= light switched on

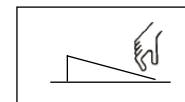

Troubleshooting / error messages

Display / symptom

Cause

Remedy

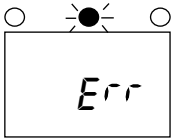

Interruption or short circuit in sensor circuit

Check KTY sensor (approx. 2 kOhm at 20° C). Check wire (red) and connections for interruption or short circuit.

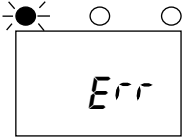

Interruption in limiter circuit

Check continuity on safety temperature limiter. Check wires (white) and connections

Unit not working
Display dark

Control unit switch switched off

Switch on control unit switch

Mains fault

Check on-site fuses and main switch

Connection diagram

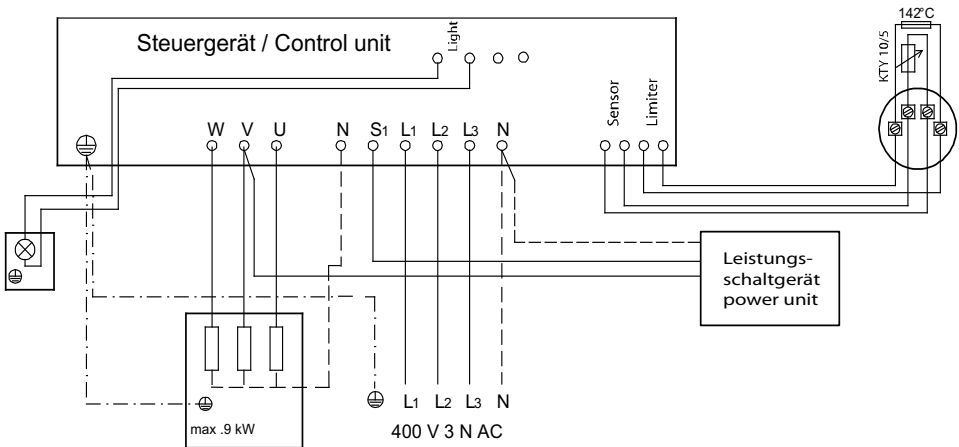

Please keep this address in a safe place together with the installation guide.

To help us answer your questions quickly and competently, please provide data printed on the ID plate, to include system type, article no. and serial no., in all inquiries.

Service Address:

EOS-WERKE GÜNTHER GmbH
Adolf-Weiß-Straße 43
35759 Driedorf-Mademühlen, Germany
Fon: +49 (0)2775 82-0
Fax: +49 (0)2775 82-431
servicecenter@eos-werke.de
www.eos-werke.de

Guarantee

The guarantee is taken over according to the legal regulations at present.

Manufacturer's warranty

- The period of warranty starts from the date of purchase and lasts up to 2 years for commercial use and 3 years for private use.

- Always include the completed warranty certificate when returning equipment.

- The warranty expires for appliances which have been modified without manufacturer's explicit agreement.

- Damages caused by incorrect operation or handling through non-authorized persons are not covered under the terms of warranty.

- In the event of a claim, please indicate the serial number as well as the article code number and type name with expressive description of the fault.

- This warranty covers damaged parts but no defects due to wear and tear.

In case of complaint please return the equipment in its original packaging or other suitable packaging (caution: danger of transport damage) to our service department.

Always include the completed warranty certificate when returning equipment.

Possible shipping costs arising from the transport to and from point of repair cannot be borne by us.

Outside of Germany please contact your specialist dealer in case of warranty claims. Direct warranty processing with our service department is in this case not possible.

Equipment start-up date:

Stamp and signature of the authorized electrician:

Handling procedures for return shipments (RMA) - Details for all returns !

Dear customer

we hope that you will rejoice in the ordered articles. Just in case that you are not entirely contented as an exception, please follow the procedures specified below. This enabling us to ensure a quick and smooth handling of the return shipment.

Please absolutely respect for all returns!

- Please add the available **RMA-voucher** always **completely filled out** together with an **invoice copy** to the return shipment! Do not stick it on the goods or on the packaging. **We do not accept the return shipment without these papers.**
- Not prepaid parcels **will be refused** and returned to Sender! Please always ask for the **RMA-No.** for the cheapest return.
- **Please pay attention that** the goods have to be sent back **without visible marks of use** in the **original scope of delivery and in original packing.**
- We recommend to use an **additional solid and break-proof covering box** which should be padded out with styrofoam, paper or similar. Transport damages as a result of faulty packing are for the sender's account.

Form of complaint:

1) Transport damage

- Please check the content of your parcel immediately and advise the forwarding company of a claim (parcel service/ freight forwarder)
- Do not use damaged goods!
- Ask the forwarder **for a written acknowledgement of the damages.**
- **Report the claim promptly by phone to your dealer.** He will discuss with you how to act in this case.
- If the transport box has been damaged, please use an additional covering box. Do not forget to add the **acknowledgement of the damage of the forwarding company !**

2) Faulty goods

- The implied warranty period is 2 years. Please contact your dealer in case of **faulty or wrong articles or missing accessories.** He will discuss with you the individual case and try for immediate and customer-friendly solution.
- For **economic returns** within Germany you will get an **RMA-number from the manufacturer.**
- All returns have to be in the **original packing of the goods with corresponding accessories.** Please repack the goods to avoid damages. In case of wrong delivery, please do not use this article !

3) Problems of installation and functioning

- Please **read the manual carefully first of all** and pay attention to the indicated assembly or installing instructions.
- **Your dealer should be the first contact person** because he knows his products best and also knows possible problems.
- **In case of function problems with an article,** please check at first whether there is an obvious material defect. The quality system in our factory reduces malfunctions of new appliances to almost zero.