

Assembly instructions and instructions for use

Infrasteam 200

Supplementary vaporiser for infrared cabin



GB

MADE IN GERMANY



Druck Nr. 29343557en/ 41.08

Table of Contents

Important notes.....	3
Installation of the supplementary vaporiser	3
Start- up	4
Operation	4
Important notes for use.....	5
Technical data.....	5
How to decalcify the device	5
Service Address:.....	6
Guarantee.....	6
Handling procedures for return shipments (RMA) - Details for all returns !.....	7

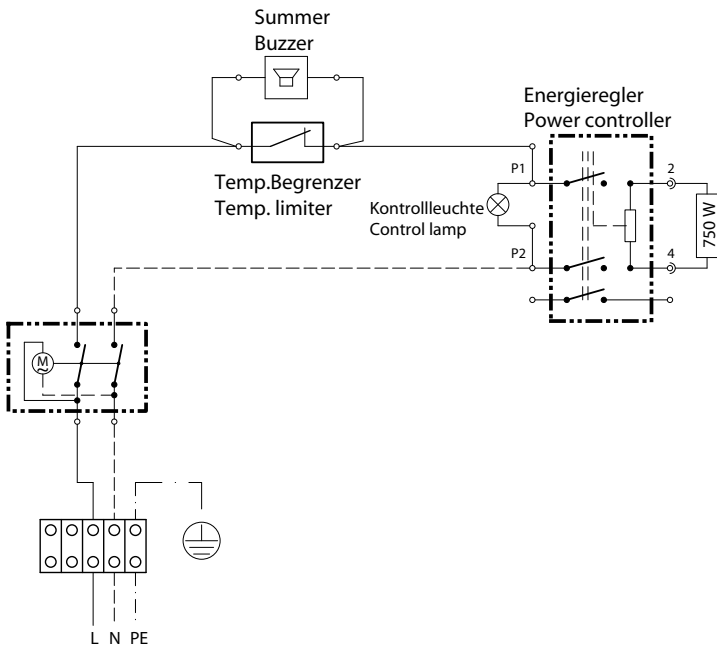

Dear customer.

You have purchased a top- quality device which will enable a wide range of different applications in your infrared warm cabin. Please read this manual carefully before activating the auxiliary evaporator.

Package contents:

- 1 x supplementary vaporiser
- 1 x plastic bag with 4 screws

Important notes

⚠ If assembled incorrectly, the system will present a fire hazard. Please read this installation guide thoroughly. It is especially important to consider applicable dimensions and observe the following instructions:

- This device has not been designed for being used by persons (including children) that are physically or mentally handicapped or have sensory disabilities. Moreover, it is not allowed to use this device without sufficient experience and/or knowledge, unless these persons will be supervised by persons responsible for their security or in case they have been instructed how to use this device.
- Children are to be supervised in order to make sure that they do not play with this device.
-  Make certain that no objects have been placed on the vaporiser unit before each start-up.
- **⚠ Caution:** High temperatures on the vaporiser unit during operation can cause burns on contact.
- The vaporiser unit is not intended for installation or placement in a niche under the bench or under a roof slope.

⚠ Caution: For infrared cabins with infrared mats, please pay attention that the attached mounting screws will not damage the mats. Ask your cabin manufacturer.

⚠ Caution: Never mount the additional vaporiser on the outside IR-cabin directly below an infrared heater.

Installation of the supplementary vaporiser

Please screw the two upper fixing screws into the wood at the recommended installation place according to fig. 2. Bear in mind that the screw-head remains separated from the wood in a distance of ca. 6 mm. Now hook the supplementary vaporiser into the two upper fixing holes and secure the device with the fixing screw in the middle hole on the top (Fig. 3).

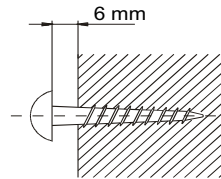

Fig. 1

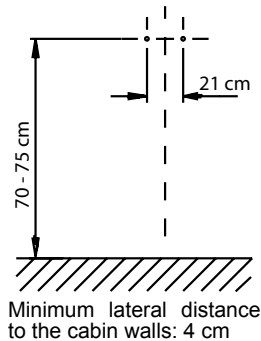

Fig. 2

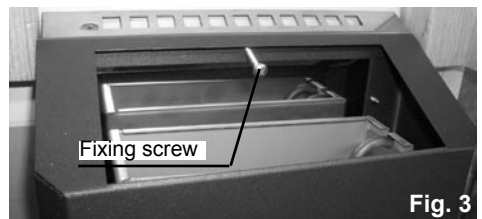

Fig. 3

Start- up

Put the mains plug in a shockproof socket with a 16 amps fuse.

Make sure that the draining- tap of the device is locked. Now fill not more than 2 litres of water into the tank. For this, you may remove the herbage-sieve.

Never add essences or essential oils to the water. You may place herbage- bags on the sieve of the blowing- out nozzle and pour essential oils in the provided bowl. During the warming, the substances will evaporate and mix with the rising steam. Drain the residual water after every operation, after the device has cooled down.

Operation

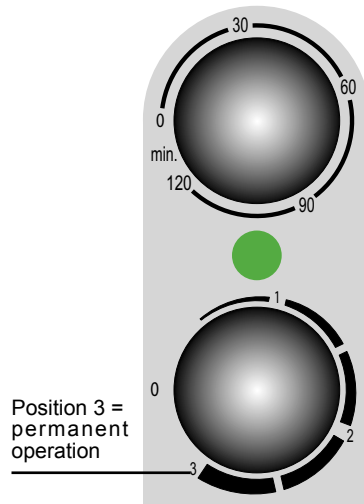

Fig. 4

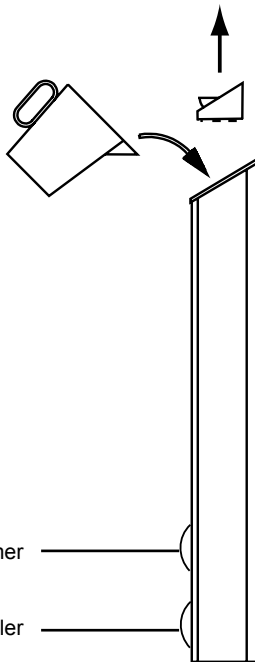

Fig. 3

The device is taken into operation with the upper knob of the timer. You can choose the operating time by turning the knob to the right side. The timer will cut-off the device automatically after the selected time.

If you want to turn off the device before expiration of the selected time, turn the button in counterclockwise direction to „0“.

With the lower button you can adjust the intensity of steam.

Please bear in mind that you cannot regulate a relative humidity value but only the steam shock at clock cycle.

The relative humidity in the cabin depends on the cabin size and the present temperature.

Based on the fact that hot air can better retain the humidity, the relative humidity with the same intensity of evaporation is lower at a higher temperature.

Since these values and temperature dependencies may vary, you should find the desired adjustment of the power controller (lower button) according to your own well-being and your cabin.

Important notes for use

Check the devices in the IR-cabin regularly.

Clean and decalcify the devices if required. In case of eventual defects or wear outs, please contact your salesman or the manufacturer directly.

If you have not used your IR-cabin over a longer period, please make sure before restarting that there are no cloths, cleansing agents or other items lying on the evaporator.



Warning!

Danger of scalding!

There are high temperatures at the steam-outlet resp. hot boiling steam exhausts.

Never add essences, essential oils or other additives to the water, but give them into the provided herbage bowl.

They will be volatilised in the rising steam which will spread them throughout the cabin.

Please pull the mains plug for any kind of service or maintenance.

How to decalcify the device

1. Open the draining- tap and drain the water which is still inside the device, then close the tap.
2. In order to decalcify you will need a bag of quick- decalcifying- agent which will be dissolved according to the manual of the producer.
3. Pour this solution into the water- filler.
4. Switch on the device after about 5 minutes and let it run until the low water control starts buzzing.
5. Immediately pour one litre of clear water into the water-filler. The buzzing fades and the device heats the evaporating system which dissolves the remaining lime-particles.

Switch off the device after about 10 minutes, let it cool down and drain the water. Repeat this procedure until there are no more lime- residues in the rinse- water.

Attention!

Decalcifying- agents are caustic, so rinse affected skin- areas or eyes immediately with plenty of cold water.

Technical data

Outer housing:	anthracite pearl effect
Storage tank:	high-grade steel
Water volume:	approx. 2 litres
Capacity acc. DIN:.....	750 W
Electrical connection:	230 V N AC 50 Hz
Installation dimensions H/W/D:	52 / 22,5 / 12 cm
Cabin size:	up to approx. 5 m ³
Weight without package:	5.6 kg

Please keep this address in a safe place together with the installation guide.

To help us answer your questions quickly and competently, please provide data printed on the ID plate, to include system type, article no. and serial no., in all inquiries.

Service Address:

EOS-WERKE GÜNTHER GmbH
Adolf-Weiß-Straße 43
35759 Driedorf-Mademühlen, Germany
Fon: +49 (0)2775 82-0
Fax: +49 (0)2775 82-431
servicecenter@eos-werke.de
www.eos-werke.de

Guarantee

The guarantee is taken over according to the legal regulations at present.

Manufacturer's warranty

- The period of warranty starts from the date of purchase and lasts up to 2 years for commercial use and 3 years for private use.
- Always include the completed warranty certificate when returning equipment.
- The warranty expires for appliances which have been modified without manufacturer's explicit agreement.
- Damages caused by incorrect operation or handling through non-authorized persons are not covered under the terms of warranty.
- In the event of a claim, please indicate the serial number as well as the article code number and type name with expressive description of the fault.
- This warranty covers damaged parts but no defects due to wear and tear.

In case of complaint please return the equipment in its original packaging or other suitable packaging (caution: danger of transport damage) to our service department.

Always include the completed warranty certificate when returning equipment.

Possible shipping costs arising from the transport to and from point of repair cannot be borne by us.

Outside of Germany please contact your specialist dealer in case of warranty claims. Direct warranty processing with our service department is in this case not possible.

Equipment start-up date:

Stamp and signature of the authorized electrician:

Handling procedures for return shipments (RMA) - Details for all returns !

Dear customer

we hope that you will rejoice in the ordered articles. Just in case that you are not entirely contented as an exception, please follow the procedures specified below. This enabling us to ensure a quick and smooth handling of the return shipment.

Please absolutely respect for all returns!

- Please add the available **RMA-voucher** always **completely filled out** together with an **invoice copy** to the return shipment! Do not stick it on the goods or on the packaging. **We do not accept the return shipment without these papers.**
- Not prepaid parcels **will be refused** and returned to Sender! Please always ask for the **RMA-No.** for the cheapest return.
- **Please pay attention that** the goods have to be sent back **without visible marks of use** in the **original scope of delivery and in original packing.**
- We recommend to use an **additional solid and break-proof covering box** which should be padded out with styrofoam, paper or similar. Transport damages as a result of faulty packing are for the sender's account.

Form of complaint:

1) Transport damage

- Please check the content of your parcel immediately and advise the forwarding company of a claim (parcel service/ freight forwarder)
- Do not use damaged goods!
- Ask the forwarder **for a written acknowledgement of the damages.**
- **Report the claim promptly by phone to your dealer.** He will discuss with you how to act in this case.
- If the transport box has been damaged, please use an additional covering box. Do not forget to add the **acknowledgement of the damage of the forwarding company !**

2) Faulty goods

- The implied warranty period is 2 years. Please contact your dealer in case of **faulty or wrong articles or missing accessories.** He will discuss with you the individual case and try for immediate and customer-friendly solution.
- For **economic returns** within Germany you will get an **RMA-number from the manufacturer.**
- All returns have to be in the **original packing of the goods with corresponding accessories.** Please repack the goods to avoid damages. In case of wrong delivery, please do not use this article !

3) Problems of installation and functioning

- Please **read the manual carefully first of all** and pay attention to the indicated assembly or installing instructions.
- **Your dealer should be the first contact person** because he knows his products best and also knows possible problems.
- **In case of function problems with an article,** please check at first whether there is an obvious material defect. The quality system in our factory reduces malfunctions of new appliances to almost zero.