

# EOS

Sauna & Spa



The  
Architecture  
of Wellness.

**CLASSIC COLLECTION**

# EOS Saunatechnik

Since 1973, EOS has stood for high-quality sauna engineering developed and manufactured in Germany. Founded in 1944, the company designs and produces premium electric sauna heaters, modern sauna control units, infrared systems and steam room equipment, as well as a comprehensive range of accessories for private and commercial wellness facilities.

With 100 % manufacturing in Germany and installations in more than 80 countries worldwide, EOS represents precision, performance and innovation in the international premium and luxury segment. Powerful engineering – including sauna heaters with outputs of up to 72 kW – meets sophisticated design and uncompromising quality.



# Table of contents

	For sauna cabin size*	Page
<b>Sauna heaters</b>		
EOS Picco series	3 - 4.5 m <sup>3</sup>	8
EOS Filius series	4 - 10 m <sup>3</sup>	12
EOS ThermoTec series	6 - 14 m <sup>3</sup>	16
EOS Gracil series	6 - 14 m <sup>3</sup>	20
EOS Euro	6 - 18 m <sup>3</sup>	24
EOS Herkules S25 series	8 - 14 m <sup>3</sup>	28
EOS FinnRock	7 - 18 m <sup>3</sup>	32
EOS Cubo series	7 - 18 m <sup>3</sup>	36
EOS PI+	11 - 25 m <sup>3</sup>	40
EOS Saunadome II	9 - 30 m <sup>3</sup>	44
<b>Infrared systems</b>		
EOS Vitae series   Vitae+ series	-	48
EOS Vitae Protect series   Vitae Protect+ series	-	50
EOS Vitae Protect Top	-	52
EOS IRS 30 Ceramic	-	53
EOS IR-heating foil	-	54
<b>Steam generators</b>		
EOS SteamAttrac	2 - 6 m <sup>3</sup>	56
EOS SteamRock II	2 - 24 m <sup>3</sup>	57
<b>Sauna accessories</b>		58
<b>Safety systems</b>		76
<b>Coloured light systems</b>		78

\*For use in interior cabins.

Subject to errors and omissions. All information is provided without warranty.

# Wellness, like clockwork.

The technical architecture behind wellness and bathing culture – this is the EOS system world. The generators create elemental sensory experiences. The control systems transform them into individually tailored, intuitive wellness.

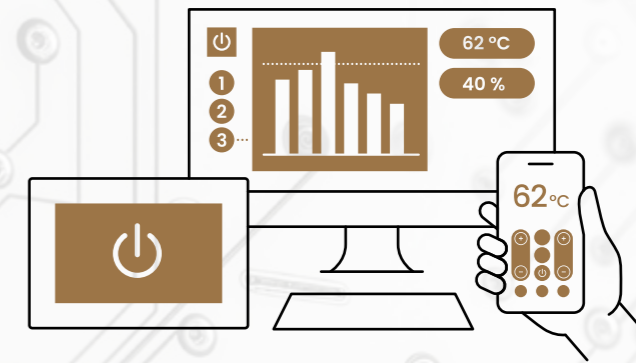

## The control systems: touch panels, app & more

For the precise effect of the generators and their perfect interaction, the control systems are essential. The EOS control concept is designed to be fully intuitive and comprehensive: from local control via the sauna control unit to the EOS app and the EOS Cloud.

This creates a perfectly balanced overall experience. Temperature, humidity and intensity interact seamlessly and can be adjusted to the moment. From activating heat to gentle relaxation – individually tailored and reproducible at any time.

## The generators: heat, cold, steam & more

Elemental encounters: EOS products of the “generator” type – such as sauna heaters, infrared heaters and steam generators – create the fundamental stimuli of every wellness application. They generate heat, radiant warmth, steam or cold and act directly on the body.

These products form the energetic core of the sauna and wellness experience. Heat stimulates circulation and relaxes the muscles, radiant heat works deep within the body, steam nourishes the skin and supports breathing, while cold activates and revitalises. This is how energy becomes a tangible benefit – for regeneration, well-being and renewed vitality.



100 °C  
dry heat

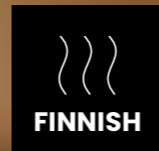

### Finnish sauna

The origin of the sauna. Dry heat – intense and pure, with infusion as a defining element. All EOS sauna heaters enable this classic sauna experience. High temperatures stimulate circulation, promote blood flow and support regeneration. Tension is released, the mind clears and the body finds rest.

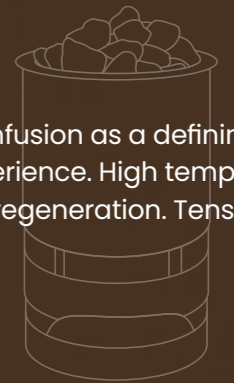

UPGRADE

65 °C  
humid warmth

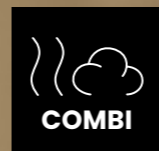

### Combi sauna

One sauna, two experiences: alongside the classic Finnish sauna, the Combi function offers a milder option with gentle heat and increased humidity.

This soft climate relaxes the body, supports circulation and deeply hydrates the skin. It promotes regeneration and creates a balanced sense of well-being.

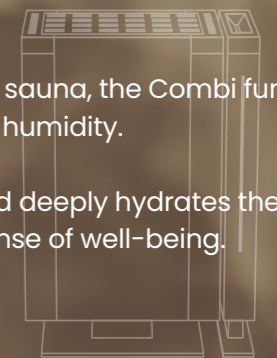

UPGRADE

Infrared  
radiant heat



### Deep heat, instantly

The Combination of sauna and infrared creates a hybrid experience that unites different forms of heat. Infrared radiation acts directly within the body, without the need for preheating. The warmth unfolds deep within, relaxes the muscles and stimulates circulation.

Ideal for targeted regeneration, relieving tension or as a quick application in everyday life. Especially after exercise, it supports muscle recovery and helps restore performance.

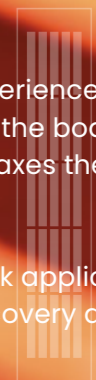

UPGRADE

Steam  
humid

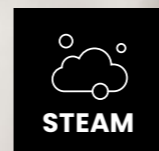

### Gentle warmth that lets you breathe

The steam bath introduces a completely different climate: cooler and more humid, with temperatures between approx. 40 to 50°C and nearly 100% humidity. The moist warmth relaxes the body, nourishes the skin and supports the respiratory system. It is particularly gentle and creates a soothing, relieving effect.

EOS steam generators stand for reliable performance and consistently high steam quality – for a stable, uniform experience.

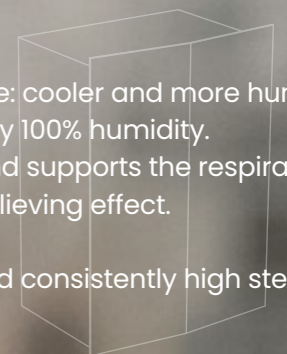

# Compact. Efficient.

The Picco models are the ideal solution for small sauna cabins. With power ranges starting at approximately 3.0 kW, they are perfectly suited for cabins with a small volume. Their particularly slim design creates valuable interior space without compromising on heating performance. Efficient air convection ensures fast heating times and a stable, pleasantly dry sauna climate.



**Space-saving:**  
A very compact sauna heater, recommended for cabins up to approximately 4.5 m<sup>3</sup>.

**Compact:**  
Rock store with a stone volume of approximately 10 kg.

**Floor-standing or wall-mounted:**  
the optional stand for the EOS Picco W turns it into a floor-standing heater.

EOS Picco W

EOS Picco W

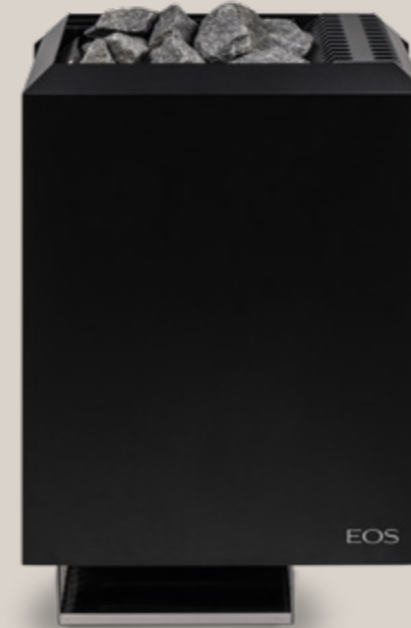

**No space? No problem!:**  
Compact, space-saving design, only 21.5 cm deep.

EOS Picco Combi W



**Finnish and Combi:**  
The Combi model with an integrated 0.75 kW vaporizer allows for flexible climate control.

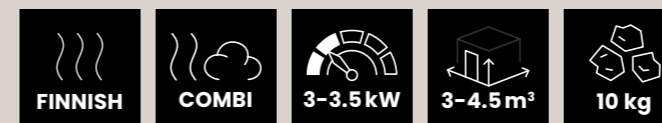

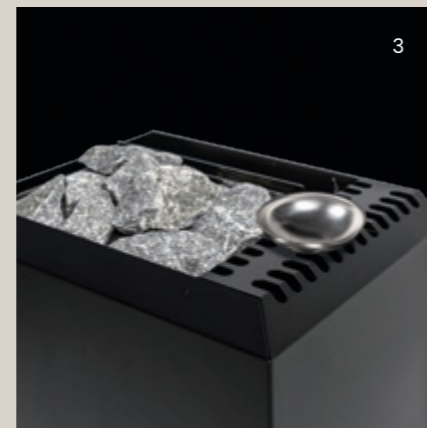

## EOS PICCO W / PICCO COMBI W



### EOS PICCO Finnish sauna heater

Stone volume: 10 kg  
Power: 3 / 3.5 kW  
Electrical connection: 230 V 1N ~ 50/60 Hz  
Installation: wall-mounted  
and floor-standing

### EOS PICCO COMBI Combi sauna heater

Stone volume: 10 kg  
Power: 3 / 3.5 kW  
Electrical connection: 230 V 1N ~ 50/60 Hz  
Installation: wall-mounted  
and floor-standing

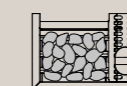
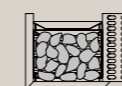
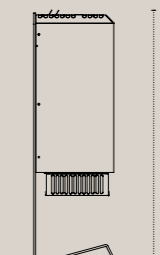
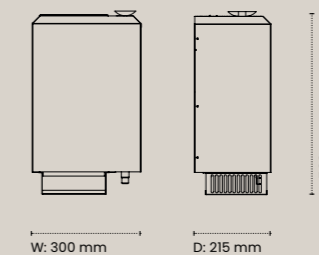
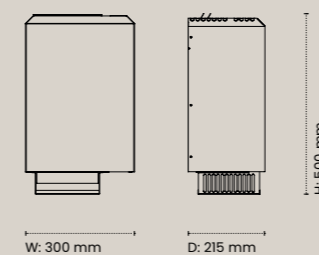

### FEATURES AND OPTIONS

- 1 A **stand** for flexible placement, for example in front of glass surfaces, is available as an optional extra.
- 2 Very **compact and space-saving**, recommended for cabins up to approx. 4.5 m<sup>3</sup>.
- 3 The **Combi model** is also equipped with a built-in vaporizer for flexible climate control. Includes a herb tray for herbs and essences. **Manual filling (approx. 2 l)**.
- 4 Inner and outer shells made of stainless steel. Available in polished stainless steel, matt black, or anthracite. Wall-mounted or with an optional stand.

### ACCESSORIES

- 1 Available with diabase, volcanic rock or white quartz sauna stones.
- 2 Unlock the full potential: With the **cloud-enabled EOS U-Command**, your sauna goes smart.
- 3 For a more invigorating sauna experience, we recommend the **sauna infusion set**, which includes a sauna bucket and a matching ladle.

### SURFACES AND COVERS



Anthracite

Matt black

# The Classic.

The Filius series has been specially developed for private saunas of medium size (up to approx. 10 m<sup>3</sup>, depending on the model). With a balanced ratio of heating power to stone volume, it ensures an even, deeply penetrating warmth. The Filius impresses with its robust construction and durable heating elements.

**Space-saving:**  
Very compact design, only 24 cm deep, for direct mounting on the sauna wall.



**Flexible heating modes:**  
The Combi model is also equipped with an integrated vaporizer for flexible heating modes.

EOS Filius W



EOS Filius Combi W



**Finnish version:**  
With a depth of just 24 cm, the EOS Filius is particularly space-saving and features a full-size rock store holding approx. 8 kg.

**Combi version:**  
0.75 kW vaporizer, can be mounted on the left or right. Herb tray for holding herbs, essential oils and essences directly at the vaporizer outlet.

EOS Filius W

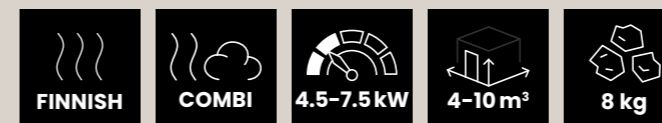



## EOS FILIUS W / FILIUS COMBI W



### EOS FILIUS W Finnish sauna heater

Stone volume: 8 kg  
Output: 4.5 / 6 / 7.5 kW  
Electrical connection: 400 V 3N ~ 50/60 Hz  
Installation: wall-mounted

### EOS FILIUS COMBI W Combi sauna heater

Stone volume: 8 kg  
Output: 4.5 / 6 / 7.5 kW | 0.75 kW Vaporizer  
Electrical connection: 400 V 3N ~ 50/60 Hz  
Installation: wall-mounted

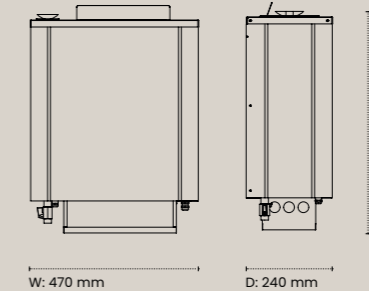
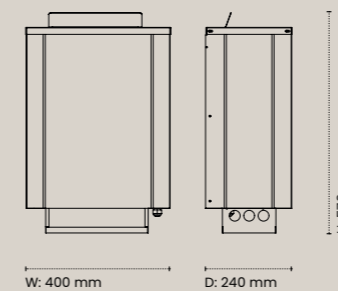

## FEATURES AND OPTIONS

- 1 With a **depth of just 24 cm**, the EOS Filius is particularly space-saving yet still features a full-size rock store with a capacity of approx. 8 kg. The heater is ideal for smaller sauna cabins, such as those found in wellness cabins like in hotel suites.
- 2 The **Combi version** is also equipped with an integrated vaporizer for flexible climate control. **Manual filling (approx. 2 l).**
- 3 Its **brushed stainless steel** top and outer shell with a scratch-resistant anthracite pearlescent powder coating make it a high-quality, robust heater.
- 4 The Filius Combifeatures a **built-in vaporizer tray** for dispensing and evaporating essential oils or fragrances.

## ACCESSORIES

- 1 Available with diabase, volcanic rock or white quartz sauna stones.
- 2 Unlock the full potential: With the **cloud-enabled EOS U-Command**, your sauna goes smart.
- 3 For a more invigorating sauna experience, we recommend the **sauna infusion set**, which includes a sauna bucket and a matching ladle.

## SURFACES AND COVERS

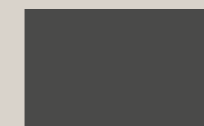

Anthracite

EOS THERMOTEC / THERMOTEC W / THERMOTEC COMBI /  
THERMOTEC COMBI W

# Elegant.

ThermoTec Combines robust technology with a modern design. Its durable construction and high-quality materials ensure long-term reliability. Thanks to efficient airflow, heat is distributed evenly throughout the room – maintaining a constant temperature from floor to ceiling.



**Water pour:**  
An optimal balance between stone volume and air convection for rapid heating times and powerful water pours.

**Striking:**  
An elegant, curved cover made from die-cast aluminium.

**Well thought-out:**  
The advantage of the stainless steel stone-holding grate is its height-adjustable stone support. The junction box is located at the rear. The base plate serves as a drip tray.

EOS ThermoTec

EOS ThermoTec



**Floor-standing model:**  
A floor-standing heater with a stone volume of 18 kg for a dry Finnish sauna.

EOS ThermoTec Combi W



**Model with integrated vaporizer:**  
The Combi model is also fitted with an integrated 1.5 kW vaporizer on the right-hand side. It includes a herb tray for herbs and essences and a stone volume of 15 kg.

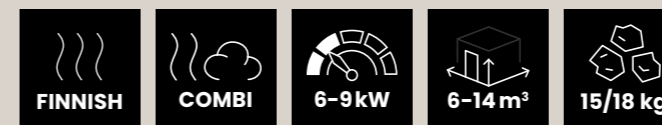

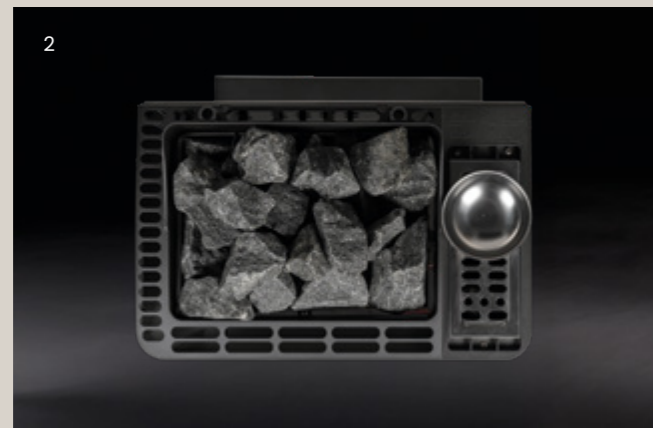

## EOS THERMOTEC / THERMOTEC W / THERMOTEC COMBI / THERMOTEC COMBI W



### EOS THERMOTEC AND THERMOTEC W Finnish sauna heater

Stone volume: 18 kg  
 Power: 6 / 7.5 / 9 kW  
 Electrical connection: 400V 3N / 230V 1N universal  
 Installation: floor-standing or wall-mounted



### EOS THERMOTEC COMBI AND THERMOTEC COMBI W Combi sauna heater

Stone volume: 15 kg  
 Power: 6 / 7.5 / 9 kW | 1.5 kW Vaporizer  
 Electrical connection: 400V 3N / 230V 1N universal  
 Installation: floor-standing or wall-mounted

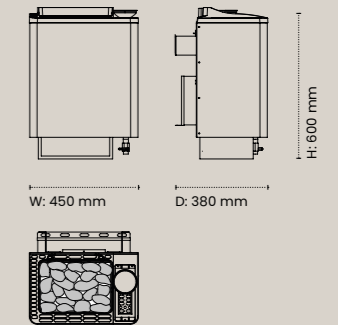
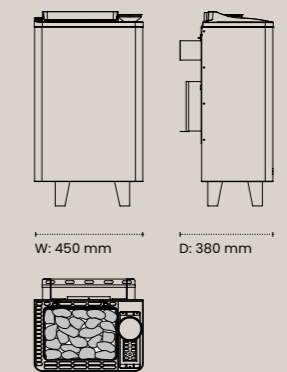
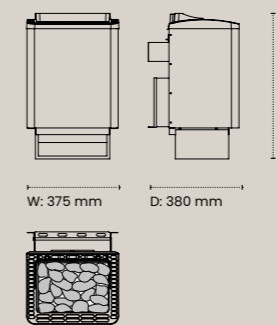
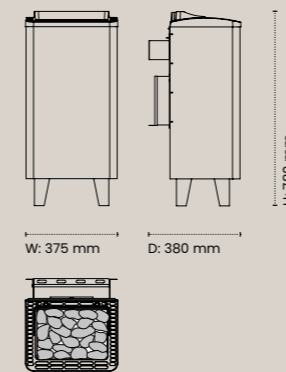

## FEATURES AND OPTIONS

- 1 The **floor-standing or wall-mounted heater** is characterised by its robust, durable construction and is ideal for modern, high-quality sauna facilities.
- 2 An optimal balance between stone volume and air convection for **rapid heating times and powerful steam bursts**.
- 3 The **Combi model** is also fitted with an integrated vaporizer on the right-hand side. It features a herb tray for herbs and essences. Manual filling (approx. 5 l).
- 4 The **curved die-cast aluminium cover**, the stainless steel inner casing and the outer shell in anthracite with a pearlescent finish give the EOS ThermoTec series a timeless and elegant design.

## ACCESSORIES

- 1 Available with diabase, volcanic rock or white quartz sauna stones.
- 2 Unlock the full potential: With the **cloud-enabled EOS U-Command**, your sauna goes smart.
- 3 For a more invigorating sauna experience, we recommend the **sauna infusion set**, which includes a sauna bucket and a matching ladle.

## SURFACES AND COVERS

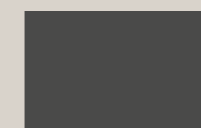

Anthracite

# The Space Saver.

The EOS Gracil impresses with its exceptionally slim design (depth of just approx. 25/27.5 cm) – ideal for small to medium-sized saunas, even when positioned directly in front of glass panels. Its robust triple-walled construction ensures efficient heat generation, whilst a rock store weighing approx. 20 kg delivers a harmonious temperature profile. The minimalist design fits perfectly with high-quality sauna interiors.

**Space-saving and powerful:**  
Triple-wall technology. Thanks to the junction box built into the heater, the Gracil is ideal for compact, high-quality sauna installations.



**Infusion power:**  
Rock store with approx. 20 kg of stones.

**A neat solution:**  
An elegant, clean-lined design with an integrated drip tray.

EOS Gracil

EOS Gracil

EOS Gracil Combi



**Floor-standing:**  
Flat rear panel with a recessed junction box – ideal for placement in front of glass surfaces.

**Model with built-in vaporizer:**  
Flexible climate control in your sauna. 0.75 kW vaporizer, approx. 2 l capacity, manual filling.

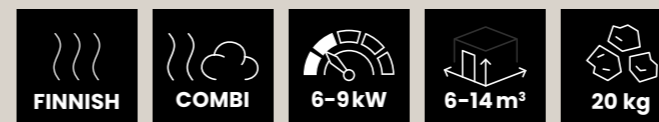



## EOS GRACIL / GRACIL W / GRACIL COMBI / GRACIL COMBI W



### EOS GRACIL UND EOS GRACIL W Finnish sauna heater

Stone volume: 20 kg  
Output: 6 / 7.5 / 9 kW  
Electrical connection: 400 V 3N ~ 50/60 Hz  
Installation: floor-standing and wall-mounted

### EOS GRACIL COMBI UND EOS GRACIL COMBI W Combi sauna heater

Stone volume: 20 kg  
Output: 6 / 7.5 / 9 kW | 0,75 kW Vaporizer  
Electrical connection: 400 V 3N ~ 50/60 Hz  
Installation: floor-standing and wall-mounted

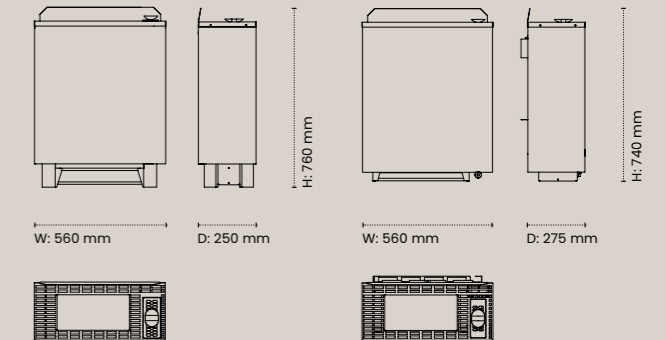
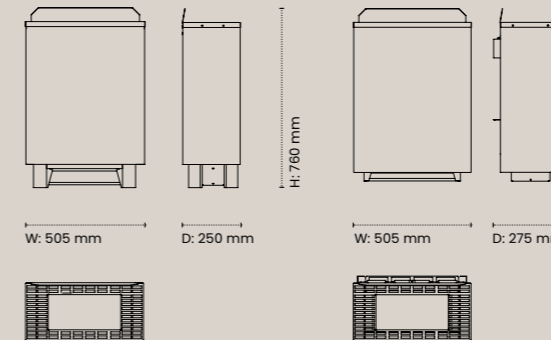

### FEATURES AND OPTIONS

- 1 **Outer shell** with an anthracite pearlescent powder coating. Upper section made of brushed stainless steel. Also available with a high-quality matt black coating.
- 2 Despite its shallow depth, the **EOS Gracil** features a rock store with a capacity of approximately 20 kg.
- 3 The **Combi model** is also fitted with a right-hand vaporizer (2 1) and a herb tray. High safety standards thanks to dry-run protection and an audible low-water warning.
- 4 Thanks to its flat rear panel and **optional designer** back panel, the EOS Gracil is ideal for placement in front of glass surfaces.

### ACCESSORIES

- 1 Available with diabase, volcanic rock or white quartz sauna stones.
- 2 Unlock the full potential: With the **cloud-enabled EOS U-Command**, your sauna goes smart.
- 3 For a more invigorating sauna experience, we recommend the **sauna infusion set**, which includes a sauna bucket and a matching ladle.
- 4 The **Scent Trophy** is an elegant design feature for your sauna, made from special heat-resistant quartz glass (P:64).

### SURFACES AND COVERS

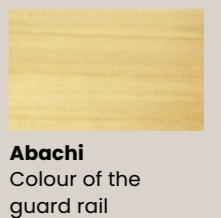

# The Wall Wonder.

The EOS Euro is the strongest wall-mounted saunaheater from EOS. It impresses with its robust triple-walled construction and high operational reliability. Designed for medium-sized saunas, it is suitable for both the discerning private sector and moderate commercial use. The sturdy steel construction with stainless steel components ensures durability, whilst the well-balanced stone volume allows for intense infusions.

**High convection:**  
An optimal balance between stone volume and air convection for rapid heating times and powerful steam bursts.



EOS Euro

**Heat distribution:**  
A rock store with a 15 kg stone volume, serving as an additional inner lining made of stainless steel.

**Floor-standing or wall-mounted:**  
Can also be used as a floor-standing model with optional feet.

EOS Euro



**Robust and tried-and-tested:**  
Thanks to its particularly robust construction featuring triple-walled technology, this model is suitable for both private saunas and commercial facilities with moderate usage in cabins up to 18 m<sup>3</sup>.

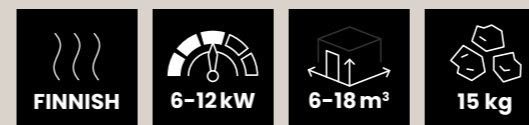

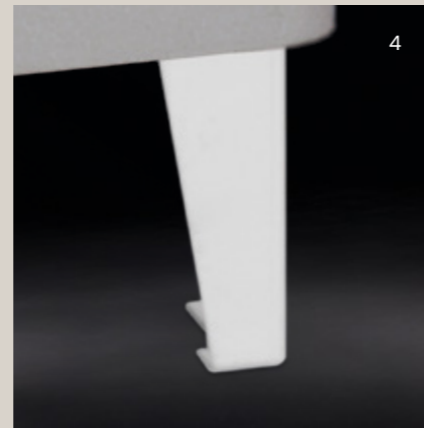

## EOS EURO



### EOS EURO Finnish sauna heater

Stone volume: 15 kg  
 Output: 6 / 7.5 / 9 / 10 / 12 kW  
 Electrical connection: 400 V 3N ~ 50/60 Hz  
 Installation: wall-mounted

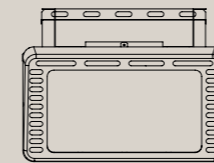
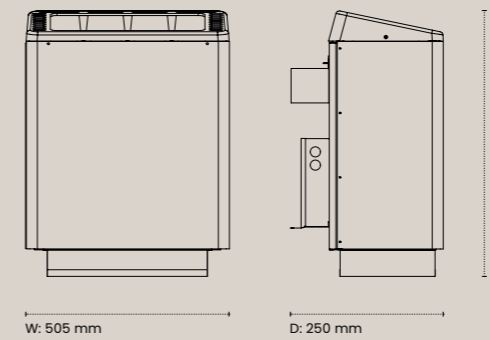

### FEATURES AND OPTIONS

- 1 Thanks to its particularly robust construction featuring triple-walled technology, this model is suitable for both **private saunas and commercial facilities** with moderate usage in cabins of up to 18 m<sup>3</sup>.
- 2 Rock store serving as an additional inner shell made of stainless steel. **Outer shell made of stainless steel.** Grey cast iron cover. Junction box at the rear.
- 3 An optimal balance between stone volume and air convection for **rapid heating times and powerful steam bursts.**
- 4 The **EOS Euro** can also be used as a floor-standing heater with optional legs.

### ACCESSORIES

- 1 Available with diabase, volcanic rock or white quartz sauna stones.
- 2 Unlock the full potential: With the **cloud-enabled EOS U-Command**, your sauna goes smart.
- 3 For a more invigorating sauna experience, we recommend the **sauna infusion set**, which includes a sauna bucket and a matching ladle.

### SURFACES AND COVERS

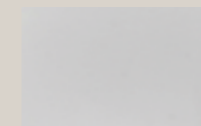

**Chrome steel**  
Polished

# Full of Contrast.

The Herkules S25 Combines powerful heating performance with sophisticated design: whether in black or brushed stainless steel, contrasting with anthracite-coloured side panelling, it makes for an eye-catching feature in any sauna. With a 25 kg stone volume, it delivers consistent, powerful heat and intense infusions – ideal for compact to medium-sized saunas. Available as an optional Combi version with an integrated vaporizer, allowing you to enjoy mildly humid climate settings too.



**Space-saving and versatile:**  
Despite the vaporizer, this sauna heater impresses with its compact design and flat rear panel.

**Long-lasting heat:**  
25 kg of stones ensure powerful infusions and exceptional heat retention.

**360° view:**  
Thanks to its flat back, the Herkules is ideal for placement in front of glass surfaces.

EOS Herkules S25

EOS Herkules S25

EOS Herkules S25 Combi



**Easy to service:**  
User-friendly design – no need to remove the stones when replacing the heating elements. The heating elements do not come into contact with the rock store.

**Model with built-in vaporizer:**  
The Combi model is also fitted with a built-in vaporizer. It includes a herb tray for herbs and essences.

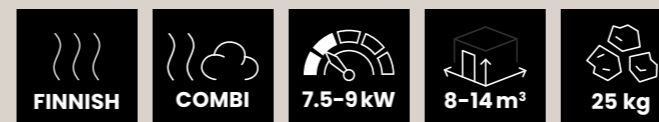



## EOS HERKULES S25 / HERKULES S25 COMBI



### EOS HERKULES S25 Finnish sauna heater

Stone volume: 25 kg  
Power: 7.5 / 9 kW  
Electrical connection: 400 V 3N ~ 50/60 Hz  
Installation: floor-standing

### EOS HERKULES S25 COMBI Combi sauna heater

Stone volume: 25 kg  
Power: 7.5 / 9 kW | 2 kW Vaporizer  
Electrical connection: 400 V 3N ~ 50/60 Hz  
Installation: floor-standing

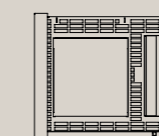
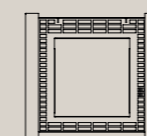
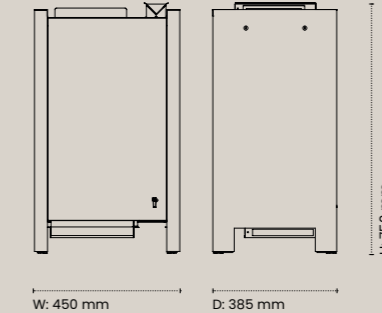
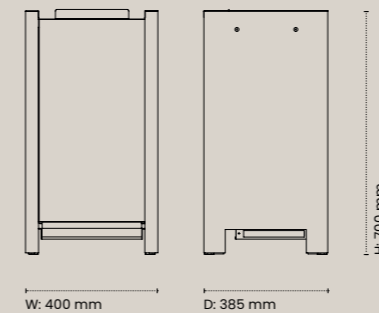

## FEATURES AND OPTIONS

- 1 The 25 kg stones ensure **powerful infusions** and exceptional heat retention. The **Combi version** is also fitted with an integrated vaporizer.
- 2 **Flexible climate control** in your sauna. Powerful 2 kW vaporizer with a capacity of approx. 5 litres, manual refill.
- 3 **Herb tray** for holding herbs, essential oils and essences directly at the vaporizer outlet.
- 4 The **brushed stainless steel front** panel stands in stark contrast to the side panels, which are finished in an anthracite pearlescent coating.

## ACCESSORIES

- 1 Available with diabase, volcanic rock or white quartz sauna stones.
- 2 Unlock the full potential: With the **cloud-enabled EOS U-Command**, your sauna goes smart.
- 3 For a more invigorating sauna experience, we recommend the **sauna infusion set**, which includes a sauna bucket and a matching ladle.
- 4 The **Scent Trophy** is an elegant design feature for your sauna, made from special heat-resistant quartz glass (P:64).

## SURFACES AND COVERS



Anthracite

Matt black



**Abachi**  
Colour of the guard rail

# An Infusion with Character.

The FinnRock is a premium-class sauna heater featuring an open rock store at the front, concealed behind an elegant expanded metal grille – which not only creates a striking design but also provides a larger surface area for infusions. The large stone filling (approx. 40 kg) ensures high temperature stability and particularly intense steam production. Thanks to its flat rear, the floor-standing heater can also be positioned in front of glass surfaces or centrally in the room.

**Space-saving and powerful:**

Just 41.3 cm wide – perfect for installation in small to medium-sized sauna cabins – without compromising on performance or functionality.



EOS FinnRock

**Heat distribution:**

Extra-large rock store with a capacity of 40 kg – for powerful infusions and high energy reserves, Combined with good air circulation.

**Open rock store:**





A unique design thanks to the semi-open rock store with a grille at the front.

EOS FinnRock



**Large stone volume:**

The specially curved slats of the expanded metal grille on the front give the heater its unique design and also ensure safety by preventing the stones from falling out.

 FINNISH	 7.5-12 kW	 8-18 m <sup>3</sup>	 40 kg
--	--	--	--



Alpha Wellness Sensations



## EOS FINNROCK



### EOS FINNROCK Finnish sauna heater

Stone volume: 40 kg  
Power: 7.5 / 9 / 12 kW  
Electrical connection: 400 V 3N ~ 50/60 Hz  
Installation: floor-standing

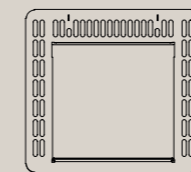
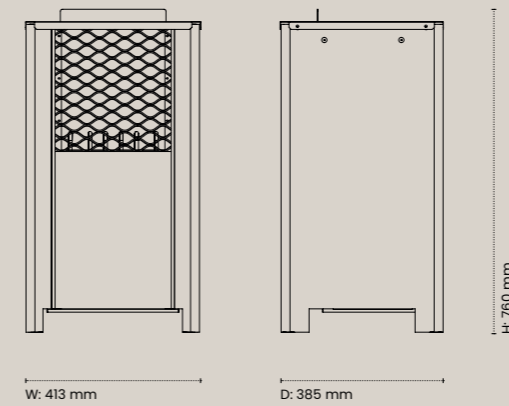

## FEATURES AND OPTIONS

- 1 Thanks to its flat back, the **EOS FinnRock** fits perfectly in front of glass panels or in the centre of the sauna.
- 2 Optional wooden **guard rail** to protect against contact with the heater, available in abachi, with colour-coordinated spacers to optionally allow the sauna builder to customise the design using a matching wood.
- 3 Create a striking, high-contrast focal point: the **EOS FinnRock** in matt black Combined with white quartz sauna stones from EOS.
- 4 The specially curved slats of the **expanded metal grille** on the front give the heater its unique design and also ensure safety by preventing the stones from falling out.

## ACCESSORIES

- 1 Available with diabase, volcanic rock or white quartz sauna stones.
- 2 Unlock the full potential: With the **cloud-enabled EOS U-Command**, your sauna goes smart.
- 3 For a more invigorating sauna experience, we recommend the **sauna infusion set**, which includes a sauna bucket and a matching ladle.
- 4 The **Scent Trophy** is an elegant design feature for your sauna, made from special heat-resistant quartz glass (P:64).

## SURFACES AND COVERS



Anthracite

Matt black



**Abachi**  
Colour of the guard rail

# Modern. Clean. Powerful.

The EOS Cubo impresses with its contemporary cubist design and versatile applications: it is suitable for medium to large sauna cabins and offers a balanced combination of radiant heat and air convection. The design is service-friendly: heating elements with no direct contact with the stones make maintenance easier and extend the unit's service life. Also available as the Cubo + with extra-large stone volume or as a Combi version with an integrated vaporizer.

**Space-saving and powerful:**  
Just 40 cm wide – perfect for installation in small to medium-sized sauna cabins – without compromising on performance or functionality.



EOS Cubo

**Heat distribution:**  
A balanced interplay of radiant heat and air convection achieved through an optimally calculated amount of stones.

**360° view:**  
The designer back panel, finished in the same colour as the heater, allows the heater to be positioned anywhere in the room.

EOS Cubo +



**Version with a larger stone volume:**  
45 kg of stones in the EOS Cubo + provide long-lasting radiant heat and enable intense infusions.

EOS Cubo Combi



**Model with built-in vaporizer:**  
Enjoy both Finnish and Combi saunas with a single heater. Thanks to the vaporizer, it also offers a gentle sauna experience.

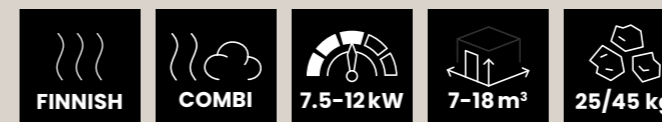

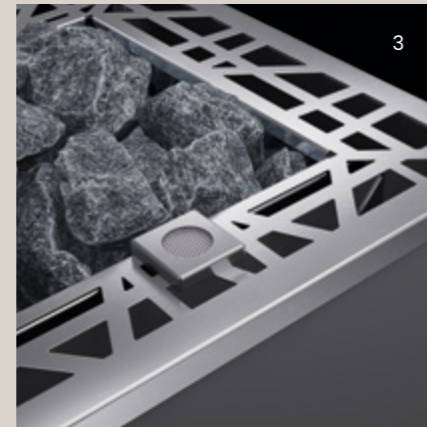
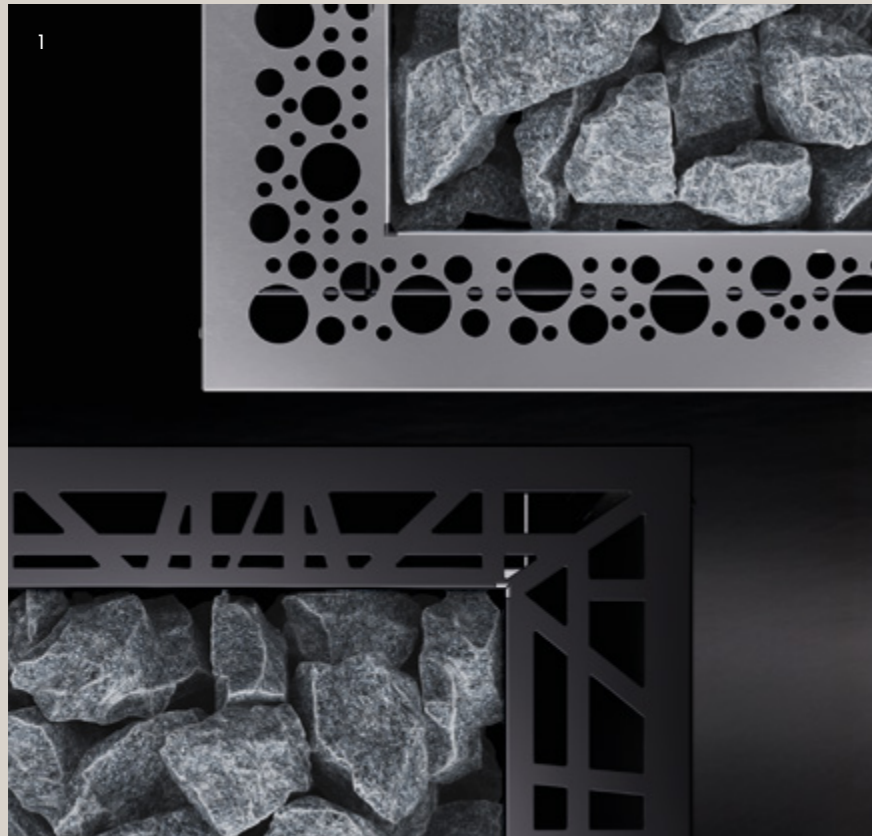

## EOS CUBO / CUBO+ / CUBO COMBI



**EOS CUBO**  
Finnish sauna heater

Stone volume: 25 kg  
Output: 7.5 / 9 / 10 / 12 kW  
Electrical connection: 400 V 3N ~ 50/60 Hz  
Installation: floor-standing



**EOS CUBO +**  
Finnish sauna heater

Stone volume: 45 kg  
Output: 7.5 / 9 / 10 / 12 kW  
Electrical connection: 400 V 3N ~ 50/60 Hz  
Installation: floor-standing



**EOS CUBO COMBI**  
Combi sauna heater

Stone volume: 25 kg  
Output: 7.5 / 9 / 10 / 12 kW | 2 kW Vaporizer  
Electrical connection: 400 V 3N ~ 50/60 Hz  
Installation: floor-standing

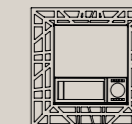
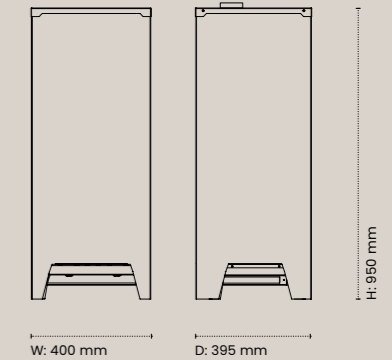
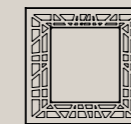
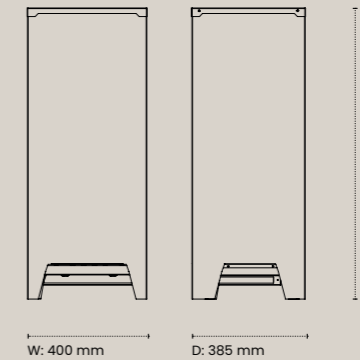
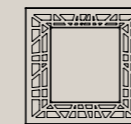
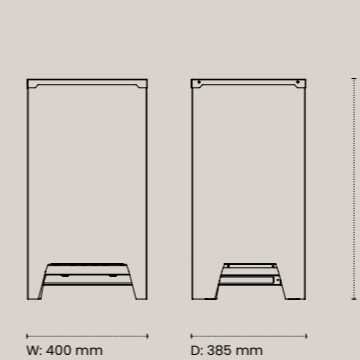

### FEATURES AND OPTIONS

- Covers** are available in one of two designs: round holes (Design 1) or textured (Design 2) – each colour-coordinated with the heater.
- Optional wooden **guard rail** to protect against contact with the heater, available in abachi or walnut, with colour-coordinated spacers to allow the sauna builder to customise the design using a matching wood.
- The optional **EOSafe L** safety system, featuring a light barrier and a reflector on the heater, detects objects in the danger zone.
- The Cubo Combi features a built-in **vaporizer tray** for dispensing and vaporising essential oils or fragrances.

### ACCESSORIES

- Available with diabase, volcanic rock or white quartz sauna stones.
- Unlock the full potential: With the **cloud-enabled EOS U-Command**, your sauna goes smart.
- For a more invigorating sauna experience, we recommend the **sauna infusion set**, which includes a sauna bucket and a matching ladle.
- The **Scent Trophy** is an elegant design feature for your sauna, made from special heat-resistant quartz glass (P:64).

### SURFACES AND COVERS

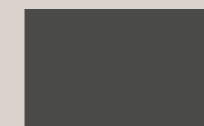

**Anthracite**



**Styling 1**  
Cover



**Styling 2**  
Cover



**Matt black**



**Styling 1**  
Cover

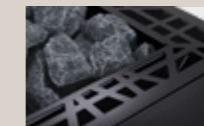

**Styling 2**  
Cover



**Abachi**  
Colour of the  
guard rail

## EOS P1+

# Powerful. Intense.

The EOS P1+ is a robust floor-standing heater with an extra-large stone volume, designed for medium to large sauna cabins. Its construction from sturdy, durable materials and its classic, functional design make it the ideal choice for sauna enthusiasts who value powerful heat and a generous supply of steam. These qualities also make it an attractive option for small commercial cabins.

**Space-saving and powerful:**  
Space-saving, flat design with a depth of just approx. 38 cm.



**Heats up quickly:**  
The large gap between the rock store and the outer shell ensures optimal air circulation and quick heating times.

**Floor-standing:**  
Thanks to its adjustable feet, the EOS P1+ can be placed even on uneven surfaces.

## EOS P1+



**Intense steam infusions:**  
Featuring an enlarged 40 kg rock store – an optimal balance between stone volume and air convection for rapid heating times and effective steam infusions.

EOS P1+

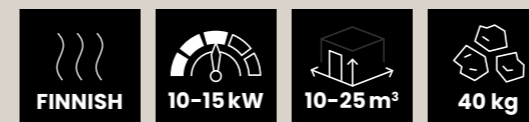



## EOS P1+



### EOS P1+ Finnish sauna heater

Stone volume: 40 kg  
 Output: 10 / 12 / 15 kW  
 Electrical connection: 400 V 3N ~ 50/60 Hz  
 Installation: floor-standing

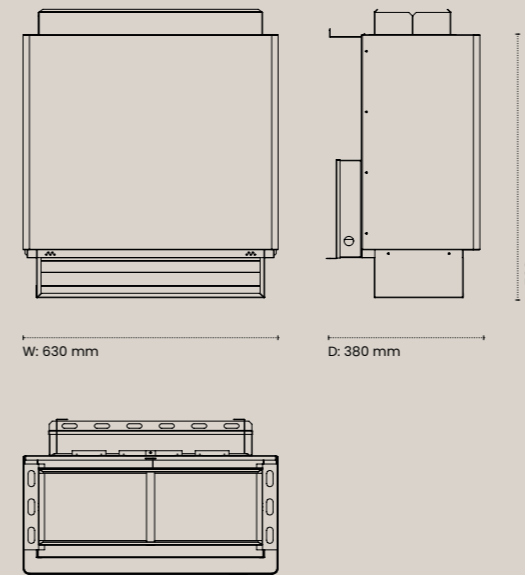

### FEATURES AND OPTIONS

- 1 Universal sauna heater for Finnish-style saunas, featuring a classic design suitable for sauna cabins ranging from 11 to approx. 25 m<sup>2</sup>. **Space-saving**, low-profile design with a depth of only approx. 38 cm.
- 2 With an enlarged **rock store holding 40 kg** – an optimal balance between stone volume and air convection.
- 3 The large gap between the rock store and the outer shell ensures **optimal air circulation and quick heating times**.
- 4 Thanks to its **adjustable feet**, the EOS P1+ can be placed even on uneven surfaces. The base also serves as a drip tray.

### ACCESSORIES

- 1 Available with diabase, volcanic rock or white quartz sauna stones.
- 2 Unlock the full potential: With the **cloud-enabled EOS U-Command**, your sauna goes smart.
- 3 For a more invigorating sauna experience, we recommend the **sauna infusion set**, which includes a sauna bucket and a matching ladle.

### SURFACES AND COVERS

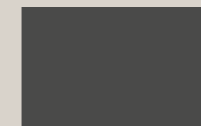

**Anthracite**



**Abachi**  
Colour of the guard rail

# The Powerhouse.

The Saunadome II is an exclusive sauna heater featuring a striking tower design and an open rock store on all sides (approx. 100 kg stone volume). This design ensures excellent heat retention and intense, even steam distribution from all directions. Thanks to its shape, it is perfectly suited for placement in the centre of the sauna interior or in front of glass panels – a premium heater for large cabins and a sophisticated infusion culture.

**Heat distribution:**  
High safety – thanks to the specially shaped grid slats, the stones always remain securely in the rock store.



EOS Saunadome II

**High capacity:**  
Sturdy stainless steel construction, adjustable feet and a rock store with a capacity of approx. 100 kg.

**360° view:**  
The same appearance from all angles – ideal for positioning in front of glass panels or in the centre of the sauna.

EOS Saunadome II



**Design follows function:**  
The extra-large rock store holds up to 100 kg of stones, ensuring particularly intense steam releases from all sides and excellent temperature stability. Thanks to its unique tower design, the EOS Saunadome II is ideal for installation in front of glass panels and in the centre of the sauna cabin.

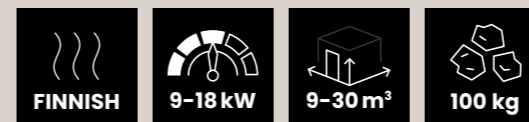

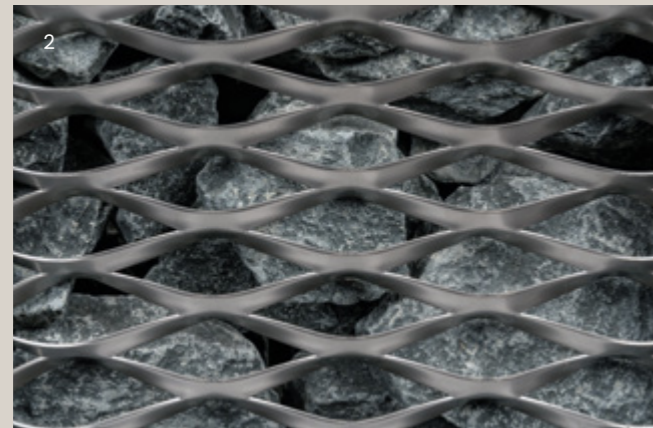
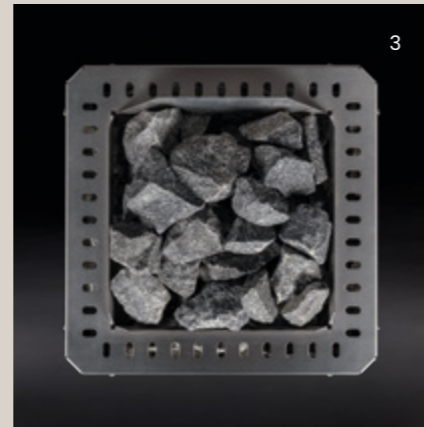

## EOS SAUNADOME II



### EOS SAUNADOME II Finnish sauna heater

Stone volume: 100 kg  
Output: 9 / 12 / 15 / 18 kW  
Electrical connection: 400 V 3N ~ 50/60 Hz  
Installation: floor-standing

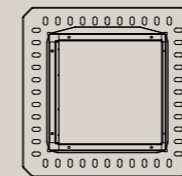
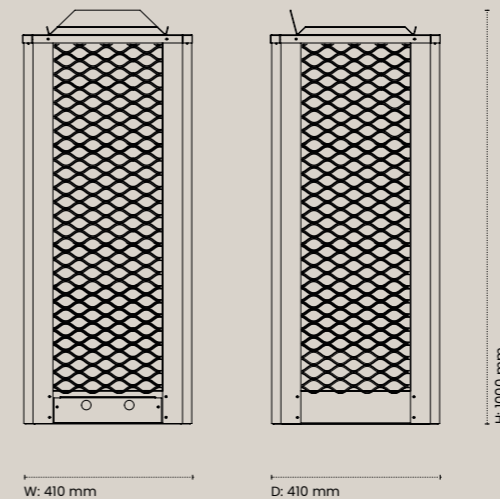

### FEATURES AND OPTIONS

- 1 Thanks to its unique tower design, the EOS Saunadome II is ideal for installation in **front of glass panels and in the centre of the sauna cabin.**
- 2 The **expanded metal mesh** provides enhanced safety whilst preventing the stones from falling out.
- 3 The extra-large rock store holds up to **100 kg of stones**, ensuring particularly intense steam releases from all sides and excellent temperature stability.
- 4 Made entirely of stainless steel, with corner profiles in an anthracite pearl finish. Upper section in brushed stainless steel. **Optimised design for improved air circulation.** Thanks to its adjustable feet, the heater can be placed securely even on uneven surfaces.

### ACCESSORIES

- 1 Available with diabase, volcanic rock or white quartz sauna stones.
- 2 Unlock the full potential: With the **cloud-enabled EOS U-Command**, your sauna goes smart.
- 3 For a more invigorating sauna experience, we recommend the **sauna infusion set**, which includes a sauna bucket and a matching ladle.
- 4 The **Scent Trophy** is an elegant design feature for your sauna, made from special heat-resistant quartz glass(P:64).

### SURFACES AND COVERS

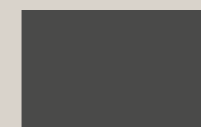

Anthracite



Abachi  
Colour of the guard rail

# Instant Heat.

The EOS Vitae infrared wall-mounted heaters provide finely adjustable radiant heat at the touch of a button, helping to soothe and relax the muscles in the back, legs or shoulders. Infrared heaters transform a traditional sauna into an infrared cabin. They promote blood circulation, relaxation and recovery.

**Ready to use:**  
Delivers infrared heat at wavelengths A, B and C – for immediate, optimal deep penetration with no warm-up time.

**Also available in "Compact":**  
The Vitae Compact models make efficient use of the available space and deliver intense infrared heat despite their compact design.



EOS Vitae+

**Flexible installation:**  
Can be mounted vertically on the wall – suitable for flush installation.

**Built-in dimmer:**  
The Vitae+ and Vitae+ Compact infrared heaters have a built-in dimmer that allows the heat output in the cabin to be adjusted.



**EOS VITAE**  
Infrared heater

Power: 350 / 500 / 750 W  
Electrical connection:  
230 V 1N ~ 50 Hz.  
Installation: Vertical.

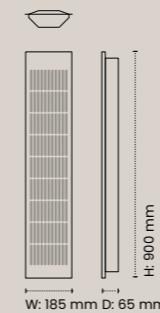

**EOS VITAE COMPACT**  
Infrared heater

Power: 350 / 500 / 750 W  
Electrical connection:  
230 V 1N ~ 50 Hz.  
Installation: Vertical.

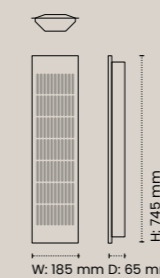

**EOS VITAE+**  
Infrared heater with  
built-in dimmer

Power: 350 / 500 / 750 W  
Electrical connection:  
230 V 1N ~ 50 Hz.  
Installation: Vertical.

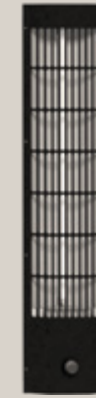
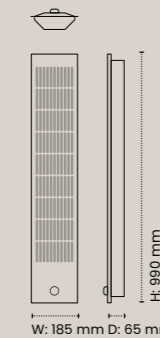

**EOS VITAE+ COMPACT**  
Infrared heater with  
built-in dimmer

Power: 350 / 500 / 750 W  
Electrical connection:  
230 V 1N ~ 50 Hz.  
Installation: Vertical.

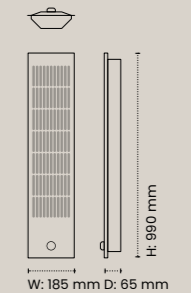

## ACCESSORIES AND OPTIONS

1 An optional, freely positionable **dimmer unit** allows you to control the radiant heat directly inside the cabin. (Only for the Vitae/Vitae Protect series, as the Vitae+/Vitae Protect+ series has a built-in dimmer)

**Sauna controls** with an infrared function are required for the installation of infrared heaters: EOS InfraTec Premium, EOS InfraStyle, EOS InfraStyle i, EOS U-Command.

**The IR heaters are supplied with pre-fitted connection cables.**



## SURFACES

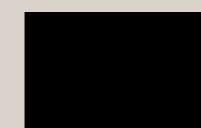

Black

EOS VITAE PROTECT / VITAE PROTECT COMPACT / VITAE PROTECT+  
VITAE+ COMPACT / VITAE PROTECT+ COMPACT

# Well Filtered.

Full-spectrum, high-performance heating element made of quartz glass. Comes with a high-quality housing, connection cable and, optionally, with or without a flocked protective grille. Features a special glass filter screen that protects the emitter and internal components from moisture.

**Ready to use straight away:**  
Delivers infrared heat at wavelengths A, B and C – for immediate, optimal deep penetration with no warm-up time.

**Also available in "Compact":**  
The Vitae Compact models make efficient use of the available space and deliver intense infrared heat despite their compact design.

**Flexible installation:**  
Can be mounted vertically on the wall – suitable for flush installation.

**Robust construction:**  
Featuring a high-quality housing, a glass-ceramic panel, a protective grille with a protective coating and black flock finish, and a connection cable.

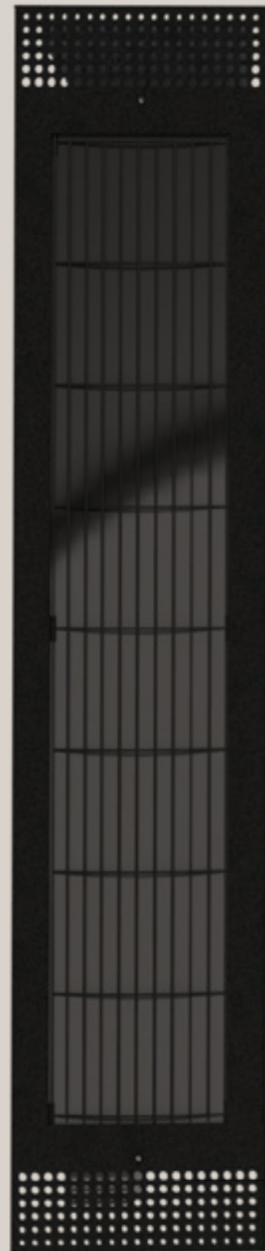

EOS Vitae Protect

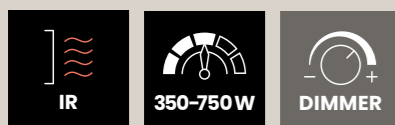

**EOS VITAE PROTECT**  
Infrared heater

Power: 350 / 500 / 750 W  
Electrical connection:  
230 V 1N ~ 50 Hz.  
Installation: Vertical.

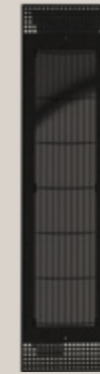

**EOS VITAE PROTECT COMPACT**  
Infrared heater

Power: 350 / 500 / 750 W  
Electrical connection:  
230 V 1N ~ 50 Hz.  
Installation: Vertical.

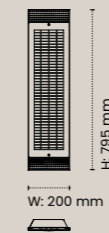

**EOS VITAE PROTECT +**  
Infrared heater with built-in dimmer

Power: 350 / 500 / 750 W  
Electrical connection:  
230 V 1N ~ 50 Hz.  
Installation: Vertical.

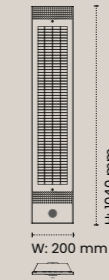

**EOS VITAE PROTECT + COMPACT**  
Infrared heater with built-in dimmer

Power: 350 / 500 / 750 W  
Electrical connection:  
230 V 1N ~ 50 Hz.  
Installation: Vertical.

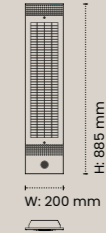

## ACCESSORIES AND OPTIONS

1 An optional, freely positionable **dimmer unit** allows you to control the radiant heat directly inside the cabin. (Only for the Vitae/Vitae Protect series, as the "Vitae+/Vitae Protect+ series" has a built-in dimmer)

**Sauna controls** with an infrared function are required for the installation of infrared heaters: EOS InfraTec Premium, EOS InfraStyle, EOS InfraStyle i, EOS U-Command.

**The IR heaters are supplied with pre-fitted connection cables.**



## SURFACES

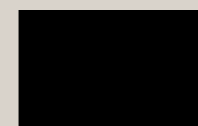

Black

## EOS VITAE PROTECT TOP

# Heat from Above.

IR radiant heaters for ceiling installation in an IR heat cabin. Vitae quartz glass emitters with 1000 and 1500 W. Includes housing and reflector. Protective flocked cover grille (black). Fully pre-assembled with two 3 m silicone connection cables (3 x 1.5 mm<sup>2</sup>).

### Distances:

The recommended distance between the spotlight and the body is approximately **80 cm**.



**Instant heat:**  
Full power in less than a second.

### Control:

To be used only in combination with a suitable control unit. The maximum total load must not exceed 3500 W.



### EOS VITAE PROTECT TOP Infrared heater

Power: 1000 / 1500 W  
Electrical connection:  
230 V 1N ~ 50 Hz.  
Installation: Ceiling mount.

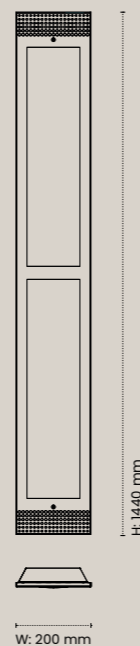

## EOS IRS 30 CERAMIC

# A real Sense of Warmth.

Infrared heat emitter for IR heat cabins. Infrared emitter for wall mounting. With pre-fitted 3 m silicone connection cable and pre-assembled plug. For indoor use only. With 300 W ceramic emitter, long-wave IR-C range. Reflector made of high-gloss polished aluminium. Housing made of galvanised sheet steel. Protective flocked cover grille (black).

### Everything included:

with reflector, protective grille and connection cable.

### Rapid heat transfer:

The favourable heat radiation properties of ceramic materials.

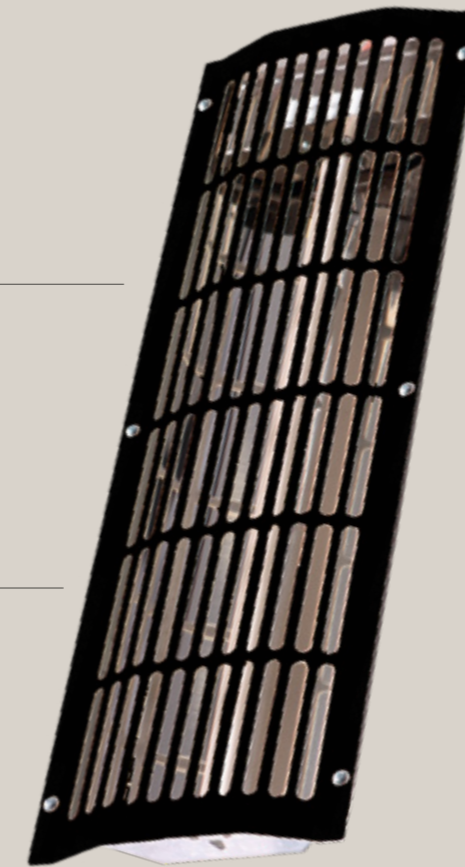

### Flexible planning:

Can be installed either in a 90° corner or within a wall unit.

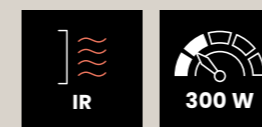

### EOS IRS 30 CERAMIC Infrared heater

Power: 300 W  
Electrical connection:  
230 V 1N ~ 50 Hz.  
Installation: Vertical.

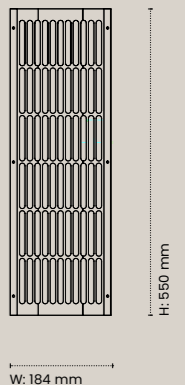

# Invisible.

EOS IR heating foil for saunas and infrared cabins. Concealed installation behind the wooden panelling. Flexible and bendable. Long-wave IR-C radiation range. Heavy metal-free. With fully automatic safety temperature limiter 110 °C. Operating temperature approx. 100 °C. Fully pre-assembled with 3 m silicone cable. Available in various power ratings and sizes.

### Langwelliger IR-C-Strahlungsbereich

Für gleichmäßige, tiefgehende Wärme nach Aufheizphase.

### Everything included:

Heavy-metal-free. With a fully automatic safety temperature limiter set to 110 °C. Operating temperature approx. 100 °C. Fully pre-assembled with a 3 m silicone cable.

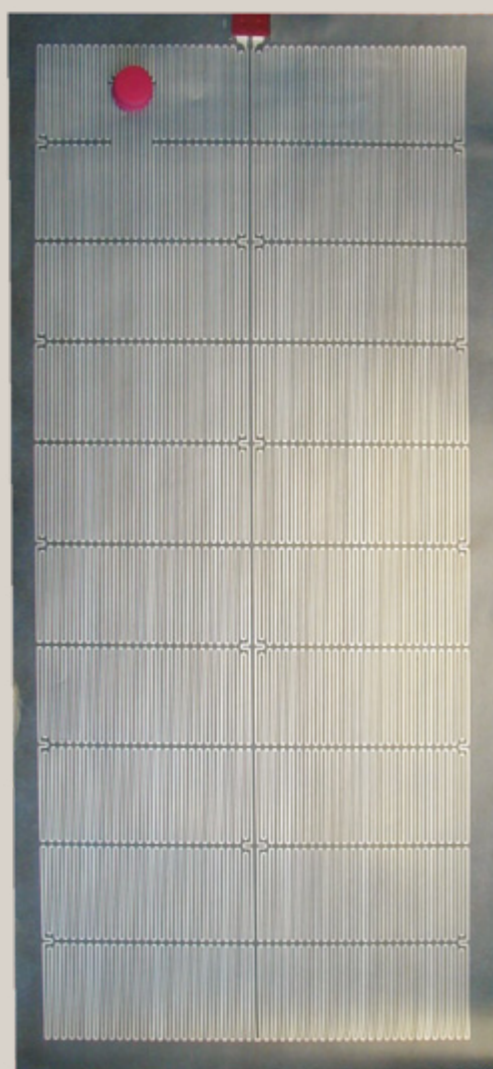

EOS IR-heating foil

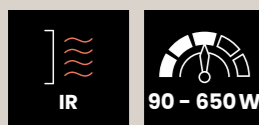

## EOS IR-heating foil

EOS IR heating foil for saunas and infrared cabins. Concealed installation behind the wooden paneling. Flexible and pliable. Long-wave IR-C radiation range.

Various power ratings: 70 / 275 / 350 / 450 / 550 / 650 W. Various dimensions, from 600 x 300 mm to 1700 x 800 mm.

Free from heavy metals. With fully automatic safety temperature limiter at 110 °C. Operating temperature approx. 100 °C. Fully pre-assembled with a 3 m silicone cable. Available in various power ratings and sizes.

For technical reasons, the actual power output may vary from the nominal value by up to +5% / -10%.

### IRF 650 W

- Dimensions H x W foil: 1700 x 800 mm
- Dimensions H x W heating surface: 1620 x 720 mm

### IRF 550 W

- Dimensions H x W foil: 1450 x 800 mm
- Dimensions H x W heating surface: 1370 x 720 mm

### IRF 450 W

- Dimensions H x W foil: 1600 x 600 mm
- Dimensions H x W heating surface: 1520 x 520 mm

### IRF 350 W

- Dimensions H x W foil: 1250 x 600 mm
- Dimensions H x W heating surface: 1170 x 520 mm

### IRF 275 W

- Dimensions H x W foil: 1600 x 400 mm
- Dimensions H x W heating surface: 1520 x 320 mm

### IRF 90 W

- Dimensions H x W foil: 600 x 300 mm
- Dimensions H x W heating surface: 520 x 220 mm

## EOS STEAMATTRAC

# The Guarantee of Steam.

It guarantees exceptional steam room and sauna experiences with a wide range of climate settings. The EOS SteamAttrac can be used as a standalone steam generator in your steam room and also as a steam source for your sauna with a humidification function. Its flexibility and compact size are particularly noteworthy. It also works well in Combination with other equipment.

### Durable:

Sturdy stainless steel water tank with long-lasting heating elements and a practical threaded fitting.

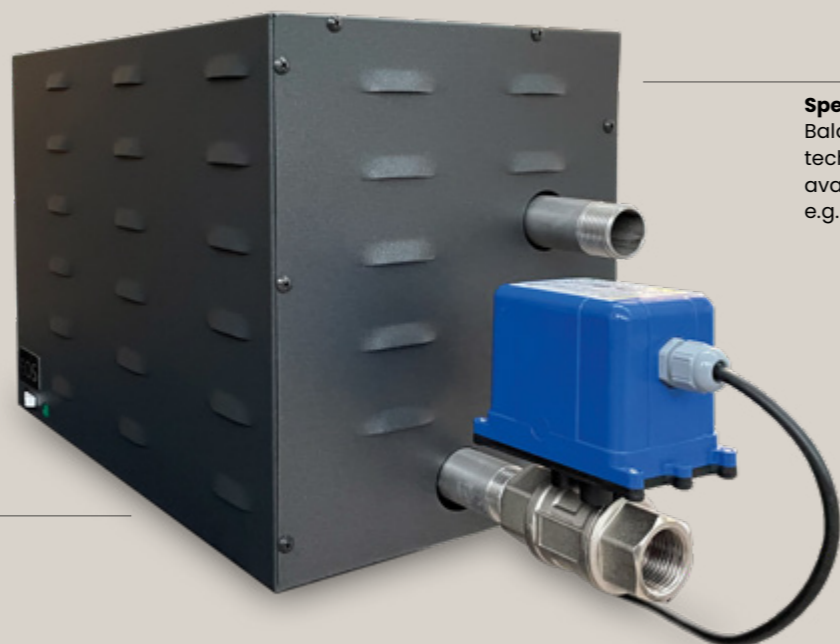

### Special solution:

Balanced – Special technical solutions available on request, e.g. for use on ships.

### Low-maintenance:

Service-friendly design, with easy access to key components during maintenance and servicing.

### EOS STEAMATTRAC Steam Generator

Power: 3 / 4 / 6 kW  
Electrical connection:  
230 V 1N ~ 50Hz / 400 V 3N ~ 50Hz.  
Steam output per hour:  
4 kg / 5 kg / 8 kg

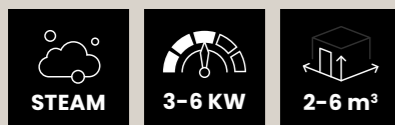

## EOS STEAMROCK II SERIES

# Full Steam.

High-performance, premium-class steam generator with up to 18 kW power for steam rooms. Ideal for both domestic and commercial use. Robust, durable construction with high-quality heating elements. Very rapid steam production, high efficiency. The unit's output can be easily adjusted on site – e.g. from 9 to 6 kW. Flexible installation thanks to variable steam outlet. Water tank made entirely of stainless steel, individually replaceable heating elements. Fully automatic operation with overheating protection. Integrated automatic self-cleaning (descaling and rinsing). Descaling agent reservoir with level sensor included in the scope of delivery.

### Durable:

Sturdy, durable construction with high-quality heating elements. Very fast steam production, high efficiency.

### Basic or Premium?:

With the EOS SteamRock II Premium, you take it one step further: touchscreen controls, integrated fragrance dispensing and a host of convenience features turn every steam bath into an exclusive wellness experience.

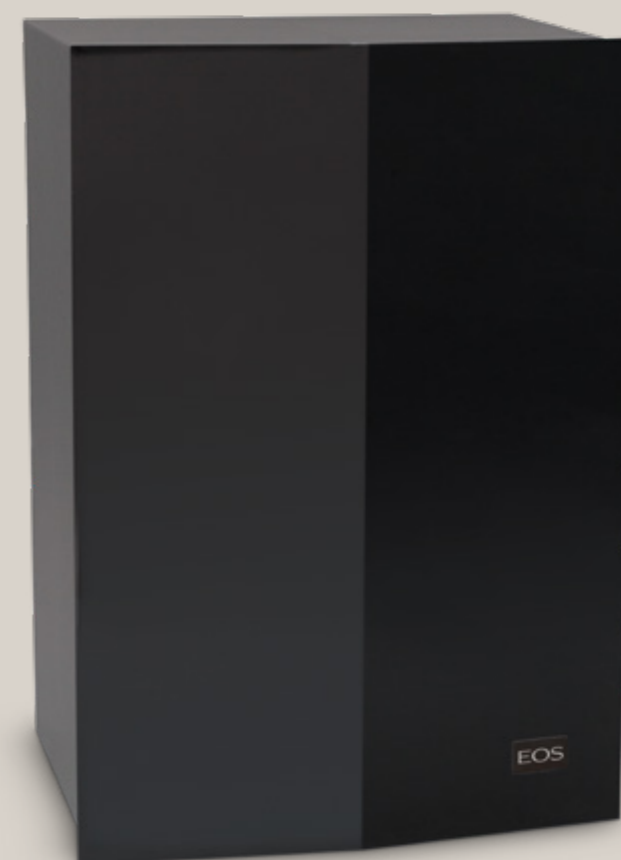

### Special solution:

With an integrated fragrance dispensing system for two scents. The unit's output can be easily selected on site. Flexible installation thanks to a variable, extra-large 1 1/4" steam outlet for efficient operation.

### Low maintenance:

Built-in descaling and self-cleaning system.

### EOS STEAMROCK II SERIES Steam Generator

Power: 3 / 6 / 9 / 12 / 15 / 18 kW  
Electrical connection:  
230 V 1N ~ 50 Hz.  
Steam output per hour:  
4 kg / 8 kg / 12 kg  
16 kg / 20 kg / 24 kg

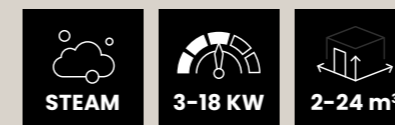



### Thermo- / Hygrometer

- Sauna thermometer, round, wall-mounted, Ø 100 mm.
- Measuring range 0–120 °C. Also available with a Fahrenheit scale on request.
- Sauna hygrometer, round, wall-mounted, Ø 100 mm.
- Measuring range 0–100% relative humidity.
- “Made in Germany” quality.

### Sauna climate station

- Sauna climate meter, Ø 100 mm or Ø 160 mm.
- Combined thermometer and hygrometer.
- Sauna measurement range highlighted in colour.
- “Made in Germany” quality.



### EOS Excellent climate station

- Exclusive weather station.
- Round measuring instruments set in an anthracite pearlescent metal plate with a frame made of fine walnut and maple.
- Ø 100 mm thermometer and hygrometer, measuring range: 0–120 °C and 0–100% relative humidity respectively. Dimensions 340 × 195 mm.
- Available in two design variants in walnut and maple:
- Type 100D – Walnut
- Type 100L – Maple



### Sand timer

- Beechwood sauna hourglass.
- Runtime approx. 15 minutes.



### EOS Excellent sand timer

- Exclusive sauna hourglass in a stylish, cubist design.
- With contrasting sand filling. Meticulously handcrafted from solid wood.
- Features an innovative self-locking mechanism that keeps it upright thanks to an integrated magnetic holder.
- Dimensions 370 x 60 x 45 mm
- Available in two designs: walnut and maple:
- Typ 15 D – Walnut
- Typ 15 L – Maple



### Sauna climate station with glass/wood design

- Sauna thermometer and hygrometer set in a stylish glass case with a wooden frame.
- Measurement range: 0–120 °C / 0–100% rel. humidity. Dimensions: 180 × 245 mm.
- Diameter of individual units: Ø 100 mm.





### Sauna set N I

Set N I, 6-piece: Consisting of a 5-litre infusion bucket, PVC bucket insert, ladle, hourglass, climate gauge (Ø 100 mm) and bathing rules board.

### Sauna backrest

- Ergonomic backrest made of poplar wood with non-slip leather pads.
- Allows for a very comfortable sitting position that can be adjusted to suit individual preferences.
- Dimensions: H x W x D 520 x 400 x 70 mm.



### Stainless steel sauna set

- A high-quality set for discerning users – extremely robust and durable. Highly resistant to corrosion, easy to clean.
- 4.5-litre stainless steel ladle with a wooden handle. Polished stainless steel ladle with a wooden handle.
- a wooden handle.



### Pail shower

- Aspen bucket with metal rings.
- Minimal effort required thanks to the tilting lever.
- Chain, fittings and tilting mechanism made from rust-resistant stainless steel.
- Adjustable water capacity from 4.5 to approx. 7 litres, with automatic refilling.



NEW

### Sauna infusion set

The sauna infusion set comprises a sauna bucket and a matching ladle, Combining modern design with functional quality.

Thanks to its low density, aspen wood heats up slowly and remains pleasantly cool even at high temperatures.

- Approx. 4-litre capacity.

### Sauna set wood

- Classic sauna bucket made from high-quality softwood, with a capacity of approx. 5 litres. Features a steel rim and handle.
- Includes a PVC liner. Classic sauna ladle made from hardwood, approx. 40 cm in length.





### Diabase sauna stones

- Very fine-grained, durable texture.
- Long-lasting, with very high heat retention capacity.
- Ideal for frequent infusions.
- Colour: Medium grey to grey-green.
- Grain size approx. 30–150 mm. Various pack sizes, e.g. 8, 15, 20, 25 kg.



### Dark volcanic sauna stones

- High-quality dark volcanic sauna stones.
- During infusions, the stone appears almost black and shimmers with numerous light reflections.
- Colour: dark grey with distinctive crystalline inclusions.
- Grain size: approx. 50–100 mm.
- Various pack sizes – 20 kg or 25 kg.



### White quartz sauna stones

- High-quality quartz sauna stones.
- Particularly suitable as decorative elements on the sauna heater.
- Snow-white stones must only be used as the top layer.
- Specially rounded shape – offer excellent infusion properties thanks to their fine-pored surface. Colour: White.
- Grain size approx. 50–80 mm.
- Pack size: 10 kg.

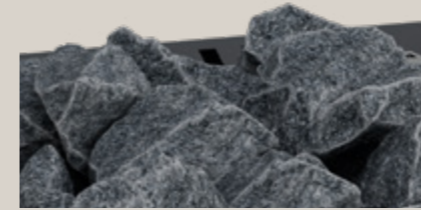

Picture shows diabase sauna stones.

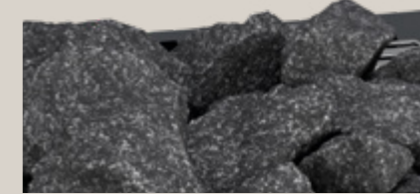

Picture shows dark volcanic sauna stones.



Picture shows white quartz sauna stones.



## EOS Scent Trophy S



- Quartz glass essence bowl, capacity up to ~0.75 l.
- No assembly required.
- Includes Himalayan salt crystals, approx. 20–24 mm.
- Ideal for sauna essences, essential oils or salt inhalation baths.
- One filling usually lasts for several hours.

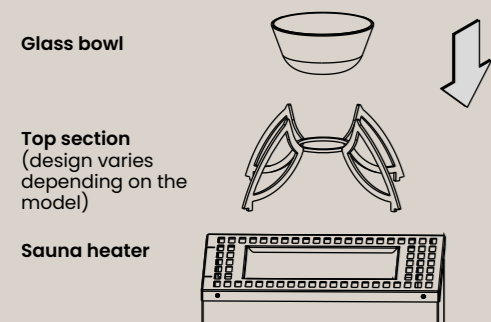

EOS Scent Trophy S2 – with EOS Cubo – Styling 1.



EOS Scent Trophy S7 – with EOS Mythos S45.



## EOS Scent Trophy W

- Quartz glass aroma bowl, capacity up to ~0.75 litres.
- Subtle elegance in your sauna – the Scent Trophy fills your sauna with wonderful scents and turns every sauna session into a special experience.
- High-quality swivelling stainless steel arm with a black lacquer finish.
- Includes Himalayan salt crystals, approx. 20–24 mm.
- Very quick and easy wall mounting.
- Ideal for sauna essences, essential oils or salt inhalation baths.
- One filling usually lasts for several hours. The swivel mechanism allows for precise positioning above the heater for a stronger or gentler evaporation effect.
- EOS Scent Trophy – manufactured exclusively in Germany!

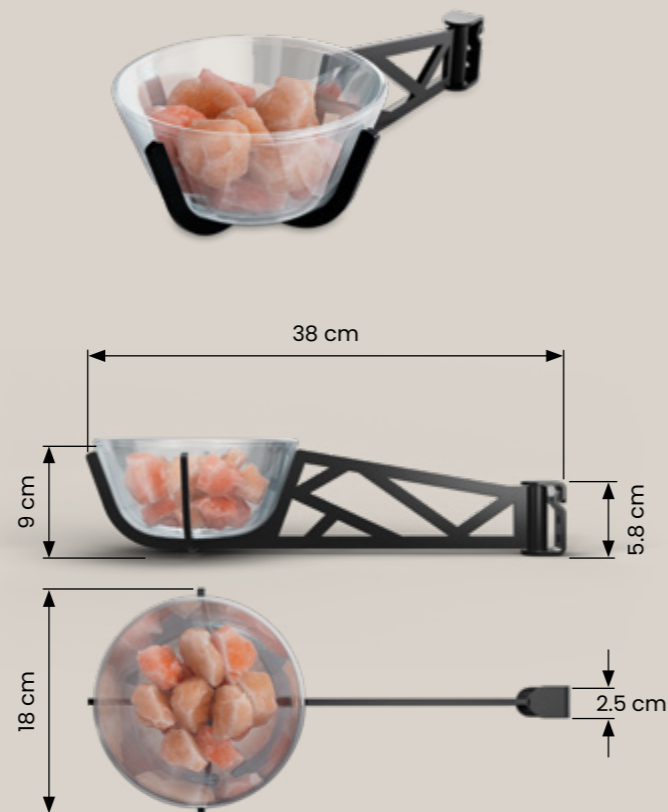

Model	Suitable sauna heaters
EOS Scent Trophy W	
EOS Scent Trophy S1	BlackRock, KUSATEK Independent
EOS Scent Trophy S2	Cubo (+, 2, 2+), Selection
EOS Scent Trophy S3	FinnRock
EOS Scent Trophy S4	Gracil / Gracil W
EOS Scent Trophy S5	Herkules / Stone S25
EOS Scent Trophy S6	Herkules / Stone S60
EOS Scent Trophy S7	Mythos S45, Credo
EOS Scent Trophy S8	Organic W
EOS Scent Trophy S9	Saunadome II
EOS Scent Trophy S10	Zeus S / SL
EOS Scent Trophy S11	Mythos S35

## Designer aroma bowl for saunas.



The EOS Scent Trophy is an elegant design enhancement for your sauna, featuring special heat-resistant quartz glass and a high-quality swivelling stainless steel arm. It is also very practical – the glass bowl can be easily removed for cleaning, and the swivel mechanism allows the bowl to be adjusted above the sauna heater, enabling you to customise the intensity of the steam.

Discover further possibilities – try the included Himalayan salt crystals to enrich the air with salt for a pleasant 'seaside atmosphere'.



### Junction box

- For connecting 400 V 3N sauna equipment to a 230 V 1N mains supply.
- This compact wall-mounted unit enables 400 V 3N sauna heaters to be connected to the 230 V 1N mains supply in accordance with best practice. Thanks to the built-in fuses, all incoming phases are protected internally by 16 A fuses.
- For sauna heaters up to a maximum of 9 kW.

### FWA Fixed water connection

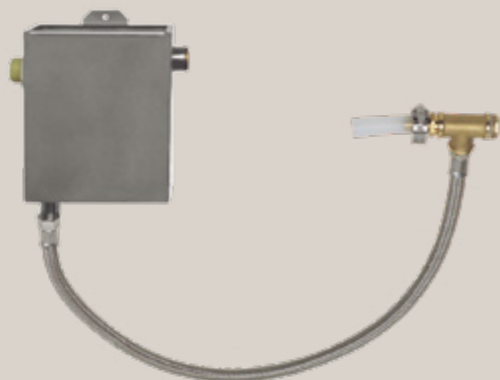

- FWA for automatic filling of the vaporizer from the mains water supply.
- Fixed water connection for EOS Combi sauna heaters. Can be fitted either directly to the sauna heater or to the sauna wall. Connects to the water supply via the supplied steel flexible hose. Hose connection 1/2".
- Very compact, space-saving design. Particularly practical for commercial use. Operates mechanically; no electrical connection required. With the option to fit an overflow protection device on site.
- FWA 02 – same as FWA 01 but for EOS Herkules S60 sauna heaters.
- FWA 03 – same as FWA 01 but for EOS Cubo Combi sauna heaters.

### Drain pan



- Plastic drain pan for collecting residual water when draining evaporative heaters.
- Plastic, black, with handle. Enables quick and easy emptying of the water tank to reduce limescale build-up.
- Fits easily under all EOS heaters thanks to its flat design.
- Dimensions (L x W x H): 420 x 220 x 50 mm.
- Recommended for all EOS Combi heaters.

### Auxiliary vaporizer

- Compact vaporizer for wall mounting in sauna cabins.
- Ideal for retrofitting or increasing the capacity of existing vaporizers.
- Filling and steam outlet via a hinged and removable herb tray. Suitable for sauna cabins up to approx. 14 m<sup>3</sup> in size.
- Vaporizer features integrated dry-run protection and an audible low-water warning. Water storage tank approx. 5 l.
- Outer housing made entirely of stainless steel. With stainless steel herb tray.
- Dimensions 60 x 31 x 14 cm
- 3 m silicone connection cable 4 x 1.5 mm<sup>2</sup> included in the scope of delivery. Power 2.0 kW. Controllable with all EOS vaporizer control units.



### Silicone connection cable

- High-quality connection cable with heat-resistant silicone sheathing.
- Ideal for connecting sauna equipment.
- Various types and designs – e.g. for sauna heaters, sensors, lighting, etc.
- Also available in other lengths on request.



Model	Length
Silicone connection cable 3 x 1.5 mm <sup>2</sup>	5 m
Silicone connection cable 5 x 1.5 mm <sup>2</sup>	2 m
	5 m
Silicone connection cable 5 x 2.5 mm <sup>2</sup>	2 m
	5 m
Silicone connection cable 5 x 4 mm <sup>2</sup>	5 m
Silicone connection cable 5 x 6 mm <sup>2</sup>	5 m
Silicone cable 2 x 0.5 mm <sup>2</sup> red	5 m
Silicone cable 2 x 0.5 mm <sup>2</sup> white	5 m
Silicone cable 3 x 0.5 mm <sup>2</sup> red	5 m



### Surround for control units

- Weatherproof housing for sauna control units for outdoor saunas.
- Softwood frame with window.
- Dimensions (H x W x D): 350 x 400 x 200 mm

### Silicone sensor cable

Silicone connection cable for sensors (silicone cable, 2 x 0.5 mm<sup>2</sup>)



Type	Length	Colour
Temperature sensor	5 m	Red
STL limiter	5 m	White
Humidity sensor F2	5 m	Red

### Temperature sensor

Replacement heater sensor, complete with housing and over-temperature protection. EOS EmoTec / EmoStyle / U-Command / EmoTouch series: Digital temperature sensor including STB over-temperature protection and sensor housing (colour: beige, black on request), with 5 m cable.

**Note:** The temperature sensor is already included with all control units.



### Bench sensor

Bench sensor for more precise control of the bath temperature. 2. Temperature sensor: Bench sensor including sensor housing and 6 m silicone cable.

Enables optimised temperature control in larger sauna installations or those with complex layouts.

EOS EmoTec / EmoStyle / U-Command / Emo-Touch series: Digital bench sensor including sensor housing (colour: beige, black on request) and 5 m sensor cable for more precise control of the bath temperature. Ideal for very large installations or saunas with complex layouts.

Optionally compatible with control units.

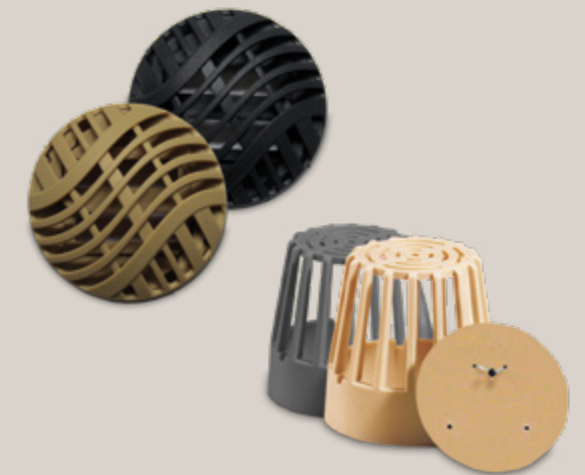

### Humidity sensor

Humidity sensor for improved control of relative humidity. F2 humidity sensor: Humidity sensor including sensor housing and 4 m silicone cable. For humidity control based on relative humidity.

EOS Compact series: Combination sensor including sensor housing and 4 m silicone cable.

EOS EmoTec / EmoStyle / U-Command / Emo-Touch series: Digital humidity sensor including sensor housing (colour: beige, black on request) and 5 m sensor cable for precise control of relative humidity (% rel. humidity).

Optionally compatible with control units

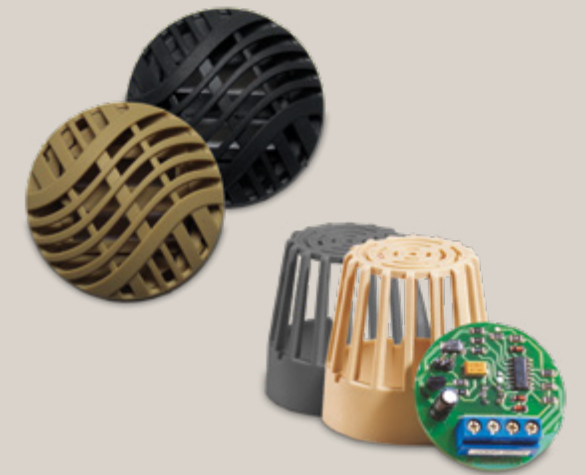



### Ventilation fan

Ventilation fan, ideal for saunas up to 16 m<sup>3</sup>. Protection class IP55, air flow rate: 160 m<sup>3</sup>/h, ball-bearing mounted. For larger cabins, additional fans must be installed in parallel within the exhaust air system in accordance with sauna installation guidelines.

- Dimensions 120 x 120 x 38 mm
- Permissible ambient temperature: -10 °C to +70 °C.

NEW



### Duct fan

Duct-mounted fan, for use in domestic saunas. This robust and compact sauna accessory ensures efficient ventilation and optimal air circulation in sauna cabins. Available in three different sizes.

- Ø 100 mm / Ø 125 mm / Ø 150 mm. Protection class IPX4 (splash-proof).
- Permissible ambient temperature: 0 °C to +45 °C.
- Note: for use in private saunas only

### Sauna loudspeakers

Built-in speakers for saunas and steam rooms. 25 W rated power handling at 8 ohms, Ø 10 cm (4"), glass fibre cone, temperature-resistant up to 120 °C – making it ideal for installation in sauna facilities; also suitable for outdoor use; seawater-resistant. White cover frame.

- Protection class IP65.
- External dimensions Ø 133 x 59 mm.

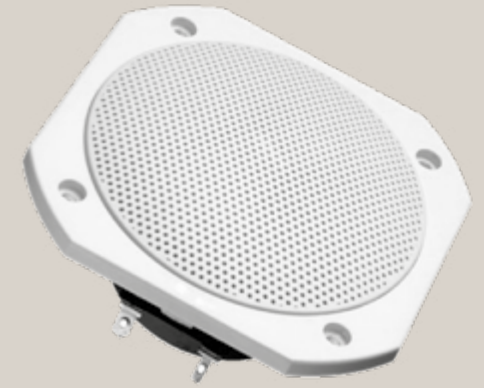

### Speakers for steam rooms

High-quality full-range loudspeaker for steam rooms. 16 cm (6.5") loudspeaker with a glass-fibre cone, plastic basket and plastic grille. Balanced frequency response, high efficiency and good mid-to-high frequency reproduction. Thanks to its IP65 protection rating, it is ideally suited for use in steam room cabins.

80 W nominal power handling (100 W max. power handling) at 4 ohms, Ø 16 cm (6.5"), 2-way coaxial speaker with injection-moulded plastic cone, plastic basket and grille. Completely corrosion- and water-resistant thanks to magnetic shielding. Additional tweeter at the centre.

- Colour: White. Also available with a high-quality matt black finish.
- Protection class IP65, -40 °C to 80 °C, seawater-resistant. 60–20,000 Hz, 86 dB average sound pressure level.

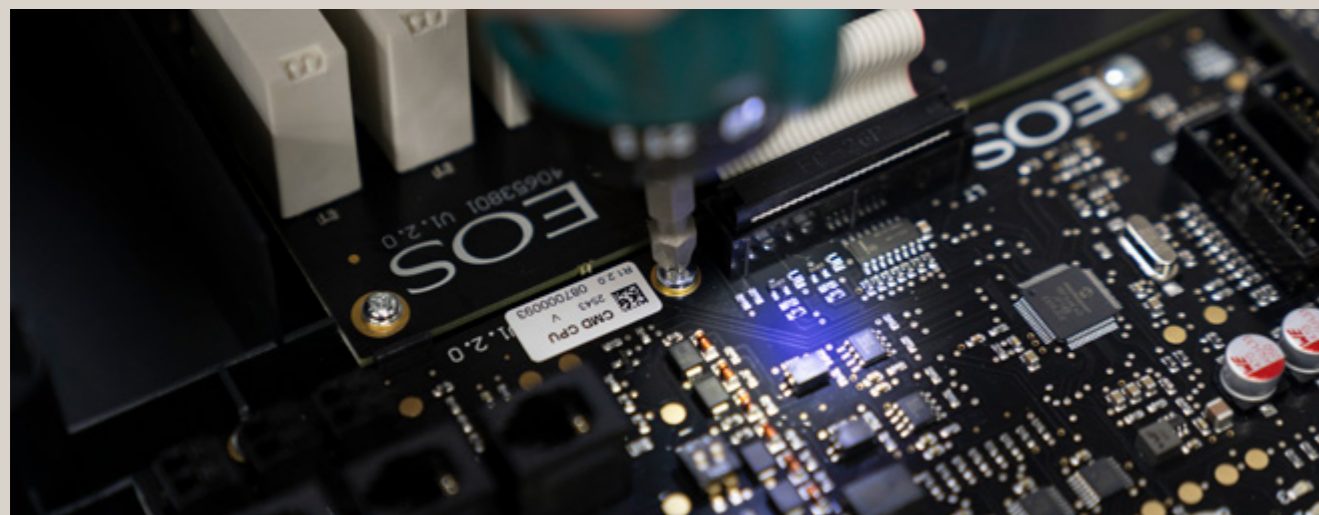

### Salt stones

Genuine Himalayan salt crystals.  
Himalayan salt for health, beauty, vitality and a zest for life.

It originated from the drying up of the primordial seas during the Permian period.

- 0.5 kg pack, e.g. for Multicup.



### Salt stones

Original Himalayan salt stones.  
Available in two versions – with all sides cut smooth or with the front side left 'natural' (rough-hewn).

- Dimensions: 200 x 100 x 50 mm.
- Pack size: 10 pieces per box, price per pack, tolerance: 3–6 mm per side



### Himalaya salt wall panel

Salt stone module in a wooden frame, filled with Himalayan salt stones, 25 mm thick. For wall mounting on load-bearing walls.

- Dimensions: 1090 x 283 x 40 mm.



### Glue for salt stones and tiles

Special salt adhesive, 1 kg pack, for bonding salt stones.

1 kg is sufficient for approx. 1 m<sup>2</sup> of bonding surface. Very easy to use, high strength.

This special salt adhesive consists of a pre-mixed two-component mixture and is ready for use (with the appropriate amount of water) for bonding salt stones together and to wood.



### Salt tile

Original Himalayan salt tiles in a set of 20. Available in two sizes – 200 x 100 x 25 mm or 200 x 200 x 25 mm.

Packaging unit: 20 pieces per box

**We recommend EOS salt adhesive for installation.**

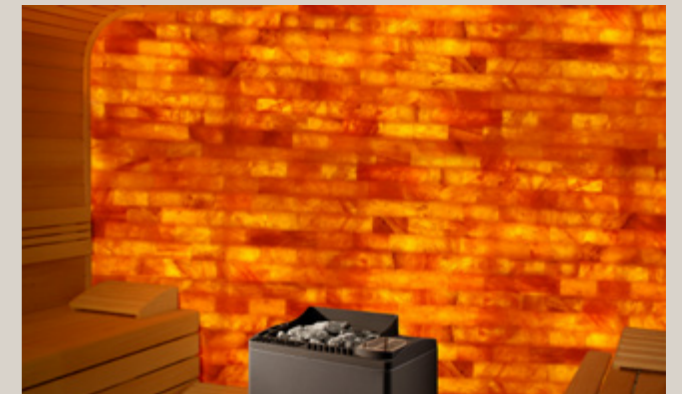



### Sauna door

- All-glass door, including 2 door hinges, with all-round seal.
- Includes door knob and door magnet. Spruce wood frame.
- Glass colour: clear
- Hinged side: universal DIN right or left.
- Glass dimensions (H x W): 590 or 680 x 1915 mm
- Wooden frame dimensions (W x H x D): 650 or 740 x 1960 x 40 mm
- 8 mm ESG safety glass

### Door magnet

Door magnet, closing force 95N and 150N.  
Dimensions: Ø15 x 8 mm.

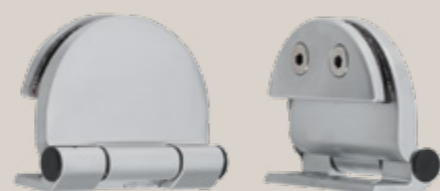

### Door hinge for 6 - 8 mm glass doors

- Door hinge for 6-8 mm glass doors made of aluminium / zinc alloy.
- Load capacity: 28 kg per hinge.
- Dimensions (W x H): 60 x 70 mm

### Door handle

- Door handle set for sauna doors in a modern design.
- Combination of beech wood for the inside and a stainless steel-look metal alloy for the outside.
- Stainless steel handle: height 300 mm, Ø 30 mm, hole spacing 200 mm
- Wooden handle: height 255 mm, Ø 31 mm, hole spacing 200 mm
- Drilling distance 202 mm, drilling diameter Ø 8 mm.
- The door handle can be fitted to doors with glass thicknesses ranging from 3 to 15 mm.



### Twin-side door hinge for 6 - 8 mm glass doors

Door hinge for 6-8 mm glass doors, 180° opening angle, made from aluminium / zinc alloy.  
For connecting one glass panel to another.

- Load capacity: 28 kg per hinge
- Dimensions (W x H): 92 x 82 mm
- **Also available in silver.**



### U-shaped metal catch for magnet locks

U-shaped retaining strip for glass doors (6 mm and 8 mm), stainless steel.



## EOSafe

The EOSafe Heater Guard lives up to its name and ensures safety in your sauna. It detects objects being accidentally left within the heater's danger zone. As an almost invisible backup, it remains discreetly in the background, so you can confidently say goodbye to unsightly, bulky installations. Whether you are configuring a new heater for yourself and want the EOSafe included, or simply wish to retrofit an existing heater, both options are possible.

### Variants:

EOSafe L  
EOSafe D

The EOSafe system is also available on request as a Combination of both variants 'L' (with a 27 mm or 52 mm reflector in stainless steel or black) and 'D', with a central control unit.

Compatible control units: EOS Econ D4/H4, EOS Compact, EOS EmoTec, EOS EmoStyle, EOS Emo-Touch 3 series



## Cover protection rail

If the switch lever is pressed down by an object, the heating process is interrupted or does not start. When the object is removed, the switch lever returns to its original position and operation resumes.

New, improved design with an internal switch – simpler and requiring less on-site installation work. The cover protection system consists of a stainless steel safety rocker switch and a safety system housed in a robust metal casing.

Wall mounting directly above the heater (Type W). Mounting directly onto a floor-standing heater (Type F) is also available on request. Thanks to five different sizes, it fits all EOS sauna heaters.

The EOS cover protection system is a tested, standard-compliant safety solution (in accordance with EU 60335-2-53). It is required for sauna installations featuring, for example, remote start, remote control or a timer function, and minimises the risk of the sauna heater being switched on whilst in an unsafe condition (e.g. a forgotten towel on the heater).

This system is required, for example, for the SBM App module for remote control via smartphones / tablets. Compatible with all EOS control units and nearly all sauna heaters.



## Emergency button

The emergency stop button allows the sauna heater to be switched off via the safety circuit in the event of an emergency. The emergency situation can also be signalled visually and/or audibly via a signalling device in a room that is permanently staffed by qualified personnel.

Also available as a set with a maple push-button plate, including mounting materials.

Dimensions of push-button plate (H x W x D):  
80 x 80 x 12 mm  
Installation depth of emergency stop button:  
85 mm



## Door contact

The door contact is the perfect addition to your smart home sauna system, enabling the safe activation of the sauna heater and other functions within the sauna cabin.

The sensor monitors only the door status (open/closed). The control unit detects if the door has been left open for too long, notifies the user and switches off the heater if the door remains open.

Compatible control units: EOS Compact DC / D18 / HC / H18 Cloud, EOS EmoTec D / H Cloud, EOS EmoStyle D / H / Hi Cloud, EOS U-Command.



### EOS LED Spot

Recessed spotlights for steam rooms and sauna cabins. LED spotlights for use in saunas, infrared cabins, steam rooms and hammams.

Elegant, timeless design. Metal housing, matt nickel. Also available in elegant matt black. Quick and easy installation and mounting, including a pre-assembled 2 m connection cable.

24 V, IP65 protection rating on the front. Heat-resistant up to at least 140 °C, electronic protection for LED chips (automatic reduction of brightness from 110 °C).

Available in RGB or warm white.

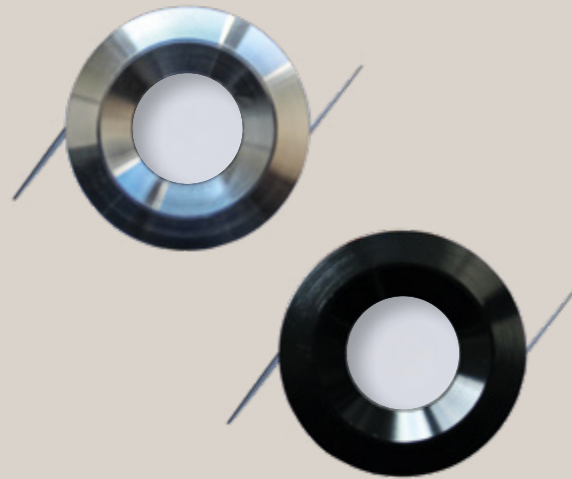

### EOS LED Spot Compact

Compact recessed spotlight for steam rooms and sauna cabins. LED spotlights for use in saunas, infrared cabins, steam rooms and hammams.

Quick and easy installation and mounting, including a pre-assembled 2 m connection cable. Elegant, timeless design. Aluminium housing with a glossy silver anodised finish. Also available in black.

Beam angle approx. 60°. Heat-resistant up to at least 140 °C, electronic protection of LED chips (automatic reduction of luminous intensity from 110 °C).

The EOS spotlights are available individually or in sets of 5 in RGB or warm white versions.

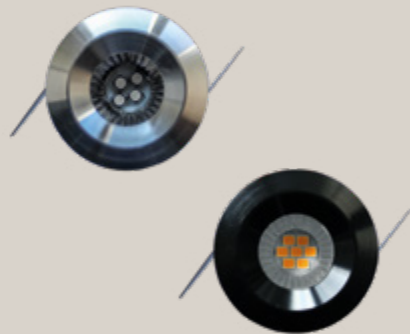

### EOS LED Strip

New, innovative LED strips with plug-in connectors on both ends – making it easy to extend the strip. Very easy to mount on any flat surface thanks to the mounting holes (spaced 16.5 cm apart).

Very vivid, high-intensity colour rendering. Three primary colours, mixed colours. Dimmable (voltage-based). Suitable for saunas with humid conditions (for steam rooms, see LED Strip Neon Flex).

Available in three different sizes as RGB and warm white (3000 K) versions. With optional connection boards, several LED strips can be connected into a single group (e.g. 2x backrest).

Voltage 24 V, rated power 3.6–4 W.

Dimensions LWH 495 / 330 / 165 x 15 x 5 mm.



### RGBW LED Strip Neon Flex

Special flexible RGBW LED light strips, universally suitable for saunas, infrared saunas or steam rooms. Very uniform illumination thanks to an opaque base and a milky, silicone-coated top surface.

Very high heat resistance up to 140°C – ideal for installation in traditional saunas.

IP67 protection rating – fully suitable for areas with high humidity (e.g. steam rooms). Universal colour output – RGB and warm white (2700 K) Combined in a single strip. High light intensity – 410 to 620 lm/m. Low energy consumption – only 15 W/m. Dimmable (constant voltage).

Available in three different sizes:

2,5 m / 5 m / 10m



NEW

### EOS LED Control

Standalone control unit for LED RGB strips and LED spotlights.

Includes a compact remote control – enabling quick and easy operation from up to 20 metres away. Direct selection of individual colours, colour changes and special effects.

Very quick and straightforward installation thanks to plug-in connections. Operates completely independently of the sauna control system.

Contents: 230 V power supply unit with mains cable (Schuko plug), control unit with pre-fitted 5 m cable, remote control with wall mount (battery included).



### Sauna lamp

- Sauna light, complete with wooden chipboard shade, 205 x 270 mm.
- Glare-free, including a splash-proof, heat-resistant (up to 150 °C) oval light, protection class IP54, made of die-cast aluminium, with a glass shade and E27 porcelain socket, bulb not included.
- Heat-resistant, compact E27 incandescent bulb for sauna cabins, 40 W.
- Alternative basic sauna light, without chipboard shade and bulb.



NEW



### Transformer for LED strips

Electronic transformer for LED strips and LED spotlights.

- 60 W / 200 W version – Output voltage: 24 V
- Dimmable
- Mains connection: 100–240 V, 50/60 Hz
- 75 W version – Input 220–240 V ~ / Output 24 V

With soft-on and fade-in functions. Dimming range: 0–100%, LED start possible at 0.1%. Up to 50,000 hours service life. Dimensions LWH: 293 × 43 × 30 mm



### Coloured Light Module (SBM-FL75/150)

Coloured light module for LED lamps. With the coloured light module, you can control almost any LED coloured light system (e.g. LED spotlights, LED strips, etc.) via your sauna control unit. No transformer required; LEDs connect directly to the module. Compatible with voltage-based (0–24 V) and current-based (0–3000 mA) LEDs.

Output: RGB (three individually adjustable colour channels) and white light (adjustable and can be synchronised with the main light). In a matching EmoTec-design housing.

Available in two power ratings: 67.5 W and 135 W. Max. 3 A per channel.

All outputs are provided in duplicate – for 6-pin flat connectors and for classic screw terminals.

Not compatible with RGB LED strips with a common '+' terminal.

#### Compatible controllers:

- EOS EmoTec series
- EOS EmoStyle series
- EOS U-Command
- EOS EmoTouch 3

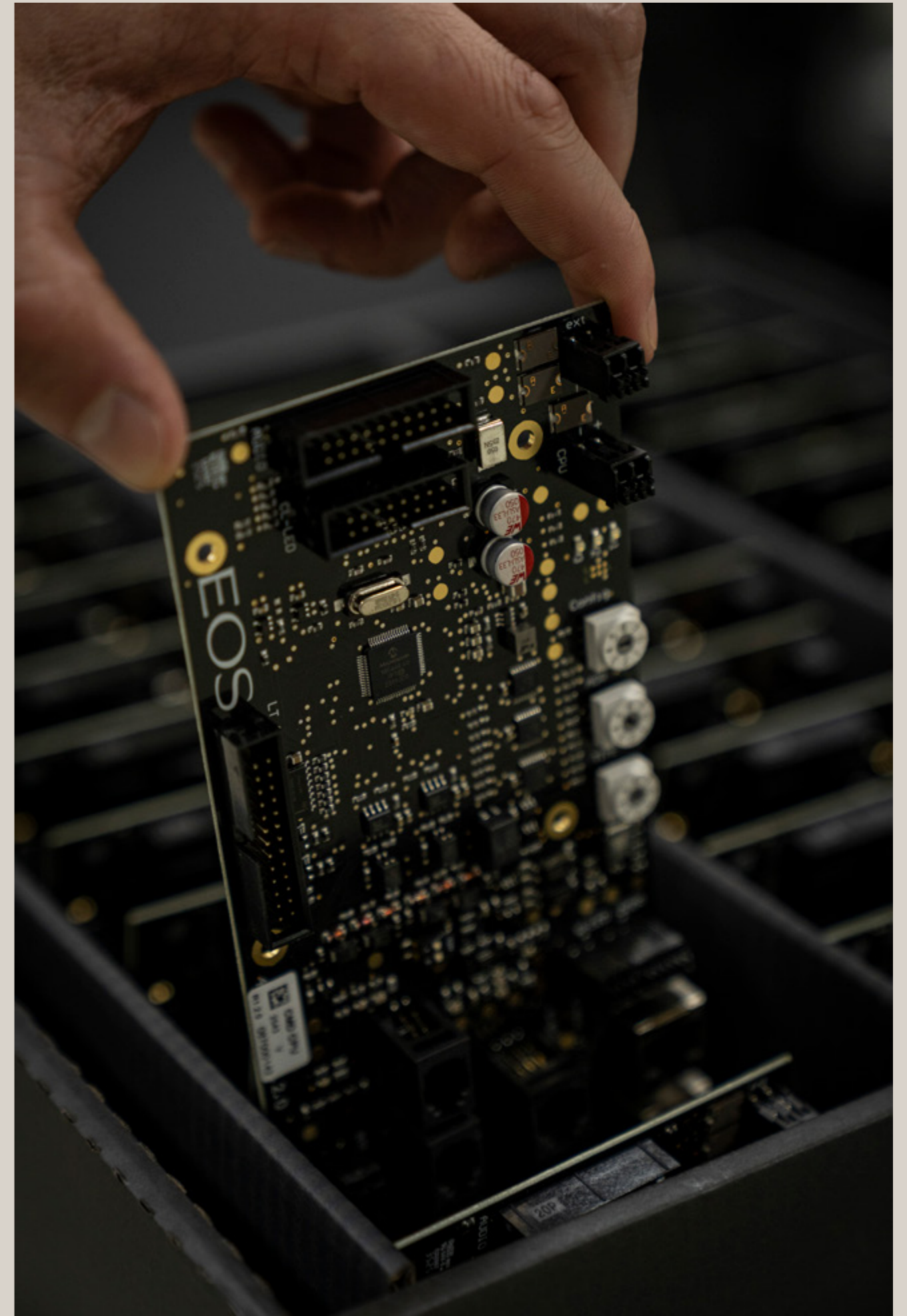

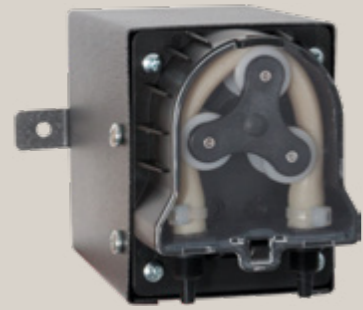

### Dosing pump

High-quality, high-performance dosing pump for fragrances in steam baths. Perfectly suited for the EOS Econ S2 control unit and the Steamtec II steam generator.

High-quality peristaltic pump with a dosing capacity of up to 5 l/h, featuring a robust metal housing with an anthracite pearlescent finish.

Supplied complete with connecting hose and injection nozzle.



### Temperature sensor

Temperature sensor for steam rooms (Sensorbus). Digital temperature sensor for steam rooms. In a special stainless steel housing. Waterproof. With a 20 cm cable and a special plug.

**Compatible with the following controllers:**

- EmoTouch 3
- LSG Steam
- SteamRock II Premium



### Fragrance essence container

5-litre tank with level sensor. For SteamRock steam generators.

### Steam nozzle

Steam nozzle with optimised steam distribution. Made from high-quality, heat-resistant plastic.

With a compartment for fragrance concentrates. 1/4" threaded connection with seal.

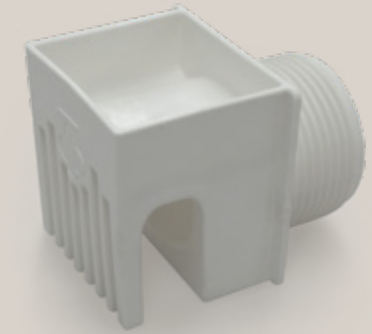

### Exhaust fan

Exhaust fan for steam rooms. Ventilation for steam room cabins.

Exhaust fan DN 100 (12.5–15 W) 230 V 50 Hz.

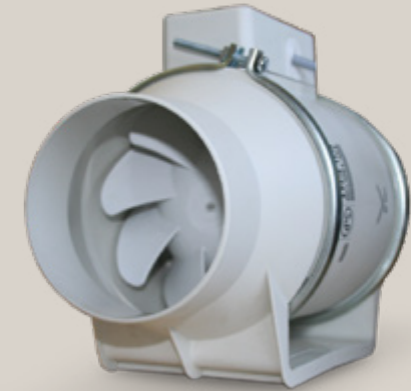

### Blower fan

Supply air fan for steam rooms. Ventilation for steam room cabins.

Supply air fan DN 100 (80W T50), including a non-return valve and a separate 5-speed speed controller.



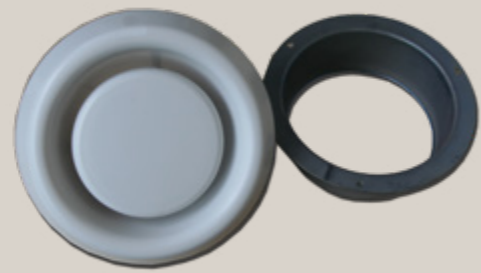

### Disc valve

Diaphragm valve for exhaust fans. Made of plastic or stainless steel.

For ceiling or wall installation.

### Water Softening System

Water softening system for steam generators and other vaporizers. Compact, highly efficient floor-standing unit with electronic control unit and salt tablet container.

Water flow rate:

- AKE40 up to 2400 l/h
- AKE120 up to 3000 l/h

Salt tablet container:

- AKE40 – 40 kg
- AKE120 – 80 kg

1/2" water connection on the control head. Protective cover for the control unit.

Operating pressure 2.0–6.0 bar.

Consumption per regeneration:

- AKE40 – 2.4 kg salt, 84 l water.
- AKE120 – 7.2 kg salt, 144 l water.

Regeneration time 25 min.



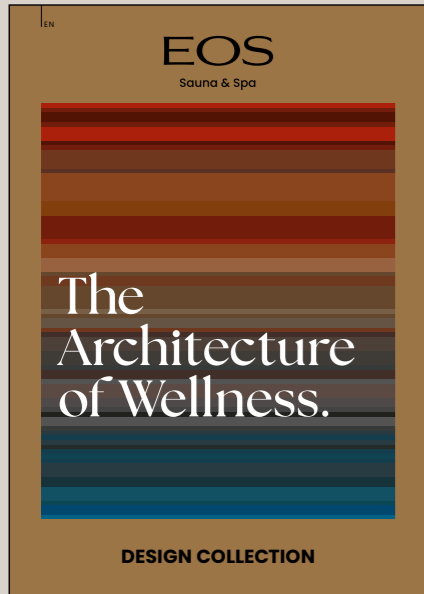

## Design Collection

In the design catalogue, you will discover sauna heaters and components that Combine functionality and aesthetics at the highest level. The focus is on exceptional forms, high-quality materials and a wide range of customisation options that integrate harmoniously into modern spa and architectural concepts. The products impress with their design flair, transforming the sauna into a style-defining feature of the room.

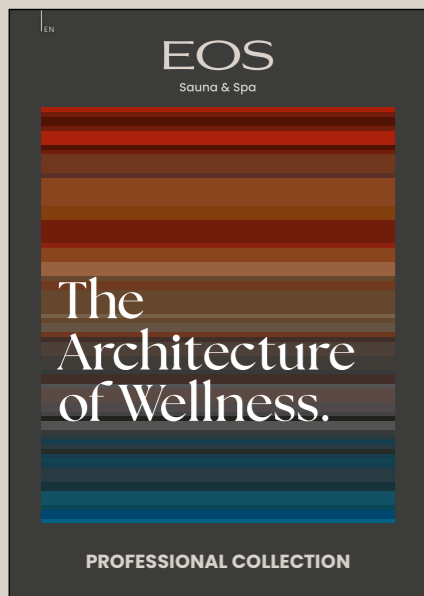

## Professional Collection

The Professional catalogue is designed for commercial use and showcases high-performance sauna heaters and systems for sophisticated spa and wellness facilities. It offers solutions for large cabins, intensive use and professional infusion concepts, Combined with the highest levels of reliability, efficiency and durable technology 'Made in Germany'.

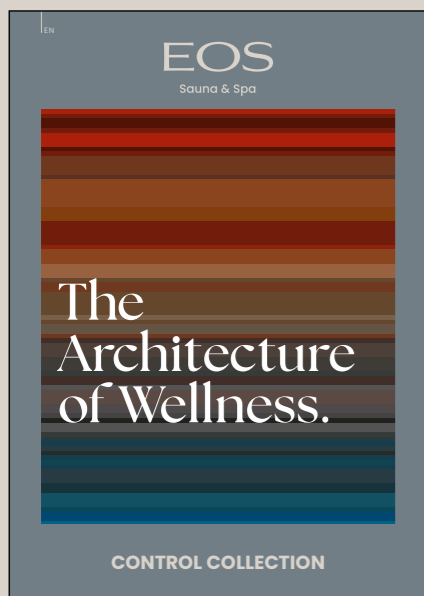

## Control Collection

In its control systems catalogue, EOS offers a wide range of smart control units for sauna, infrared and steam applications. From classic control panels to modern touchscreen and app-based solutions, they enable convenient, precise and intuitive control of all key parameters – such as temperature, humidity and operating time – for a personalised wellness experience.

# EOS

B05067 EN V2.0 05/2026



# The Architecture of Wellness.

EOS Saunatechnik GmbH  
Schneiderstriesch 1  
D-35759 Driedorf  
[www.eos-sauna.com](http://www.eos-sauna.com)

Made in Westerwald, Germany