

ECON I1

control unit for infrared warming cabins

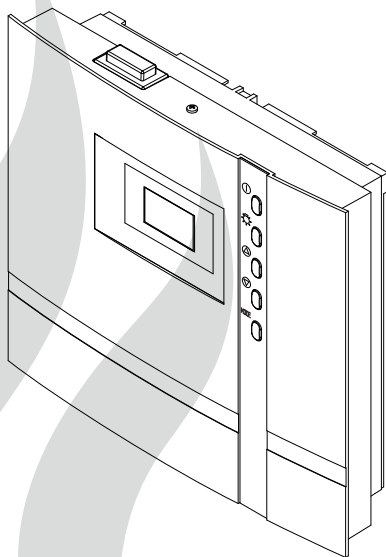

EN Installation and operating instruction

Made in Germany

  IPx4

Firmware R4.35

Druck Nr. 2934 4778en / 24.18



English

Table of contents

General Information.....	4
General safety precautions.....	5
Scope of Delivery	7
Technical data.....	8
Installation of the control unit.....	9
Wall installation.....	9
Surface-mounted installation.....	9
Recessed installation	10
Connecting the sensor cables	11
Installation of the main sensor.....	11
Electrical connection	13
Installation of IR-radiator.....	13
Connecting the cabin lamp.....	13
Installation diagram	14
Terminal arrangement on the circuit board	14
Connection diagram for IR-radiators	15
Operation	16
General information.....	16
The user interface	16
Operating buttons.....	16
Default display Stand-by.....	17
Default display in operation.....	17
Energy-saving display.....	17
Symbol description	18
Operation principle.....	19
Initial commissioning	20
Switching the IR-unit on / off.....	21
Temperature query.....	21
Individual settings	22
Cabin temperature	22
Auto-stop / heat-up time limitation.....	23
Cabin lighting.....	24
Advanced settings	25
Change language.....	25
Change time	25

Activate / deactivate the child lock	26
Activate / deactivate the Life - Guard	26
Life-Guard	27
Switching on the IR unit with Life-Guard	28
Holiday home - Holiday park mode.....	29
Device fuses	30
Error messages	31
The device „Switch-off“ switch	32
Recycling	33
Service address	33
General Terms and Conditions of Service.....	34

Dear customer,

with this IR-control unit, you have received an advanced electronic device, which was developed and manufactured to meet to the highest quality and safety standards.

The following operation instructions describe how to use the control unit.

Read these instructions carefully and keep it for future references, in order to quickly and easily operate your infrared cabin.

General Information

The IR control unit is designed for a power supply of 230 V 50 Hz and must be separately protected with 16 A.

According to the valid regulations, the electrical connection of the control unit and the electric components has to be carried out through the specialist of an authorized electric shop. Please check the regulations according VDE 0100 Part 703/2006-2.



To ensure a reliable and trouble-free operation please read the following installation guidelines and manual. Make yourself familiar with all operation steps.

Make sure to also observe the specifications and instructions of the cabin manufacturer.

Note!

Connecting the mains inputs L1-L3 to only one phase is not permitted!

General safety precautions

- This device can be used by children aged 8 upwards and by persons with physical, sensory, or mental disabilities, or who have inadequate experience and knowledge if they are supervised or if they have received adequate instruction in how to use the device safely and understand the associated risks. Children may not play with this device. Children may not clean or carry out any user maintenance if unsupervised.
- Children are to be supervised in order to make sure that they do not play with this device.
-  Attention: It is forbidden to install the control box in a closed switch cabinet or behind a wooden panelling!
- The electrical installation may be done only by a qualified electrical technician.
- You must comply with the regulations of your power supply company and the applicable local legal regulations, such as e.g. VDE regulations (DIN VDE 0100).
-  WARNING: Never attempt repairs or installations by yourselves, as this could result in serious injury or death. Only a qualified technician is allowed to remove the housing cover.
- Please note the dimensions in the assembly instructions, especially when installing the temperature sensor. The temperature above the oven is critical for the temperature setting. The temperature can be held within operating parameters and a minimal temperature gradient inside the cabin can be achieved only if unit is installed correctly.
- The device may only be used as intended as a control unit for IR radiators or IR heating foils.
-  Only the IR radiators or heating foils with the integrated overheating protection 140°C compliant with the EN 60335 norm are permitted to be used.
- Completely disconnect the control unit from the electrical circuit, i.e. flip all circuit breakers or the main circuit breaker during each installation or repair.
- Please observe the safety and installation information of the manufacturer of the IR heating equipment.
- Make sure to also observe the specifications and instructions of the cabin manufacturer.

 **Attention!**

Dear customer,
according to current legal regulations, the electrical connection of the IR radiator and the control unit has to be carried out through the specialist of an authorized electric shop.

We would like to draw your attention that in case of a warranty claim, you are kindly requested to present a copy of the invoice of the executive electric shop.

 **Attention!**

Only the original spare parts may be used.
Any modification of the cables included in the delivery can lead to malfunctions and is not permitted.

Any unauthorized technical alteration makes the product warranty void.

Scope of delivery

(changes without prior notice reserved)

The package contents includes:

1. Control unit
2. Temperature sensor, consisting of: sensor circuit board with overheating protection fuse, KTY-sensor, sensor housing, two 3x25 mm fastening screws and 2,0 m sensor cable.
3. Plastic bag with three 4x25 mm fastening screws.
4. 5 rubber cable glands
5. 1 replacement overheating protection fuse
6. Installation and operating manual

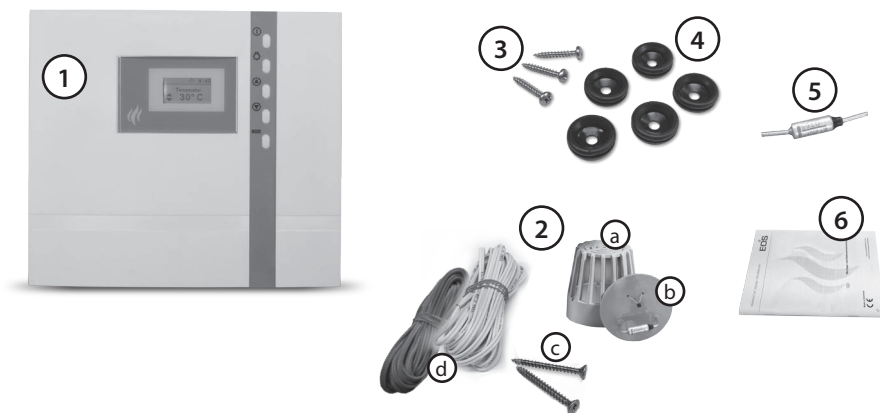

Technical data

Voltage (power supply)	400 V 3 N 50 Hz AC
Switch output	max. 9 kW resistive load (AC1 mode).
Heating time limit:	12 h
Display	LCD display 40 x 22 mm, graphic
Dimensions (HxWxD)	220 x 250 x 67 mm
Protection type	IPx4 acc. to EN 60529 splashwater protection
Temperature control range	30 to 70 °C
Sensor system (temperature)	KTY-sensor with safety temperature limiter 139 °C
Control characteristic	Two-point control with fixed hysteresis of 3K. For control via the stove sensor offset of 7K to compensate the higher temperatures directly below the cabin ceiling
Light	max. 100 W
Ambient temperatures	-10 °C to +40 °C
Storage temperature	-20 °C to +70 °C
Temperature display temperature sensor	Current value on the sensor minus 7K to compensate the higher temperatures directly below the cabin ceiling

Installation of the control unit

Wall installation

The control unit may only be mounted outside the IR-cabin. It is advisable to select the outside wall of the cabin to which the IR-radiator is fixed from the inside as mounting position. If ductwork is already provided for electrical installations then the position of the control unit is predetermined by that. Please follow the instructions for installation:

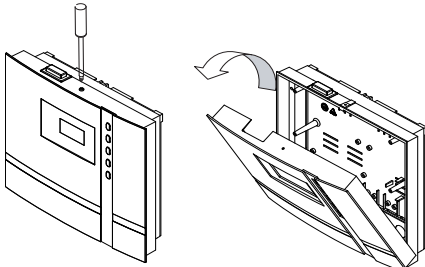

Fig. 1

Remove the control device cover. In order to do this loosen the screw at the top of the housing and pull the housing top upward while swivelling (Fig. 1).

Surface-mounted installation

1. The 3 mm diameter boreholes for the supplied wood screws 4 x 20 mm are drilled according to the dimensions shown in Fig. 2 + 3.
2. Insert one of the wood screws into the top center hole. The control unit is hooked onto this screw. Therefore, leave the screw out by approx. 3 mm (Fig. 3.1).
3. Hook the control unit onto the 3 mm protruding screw in the upper mounting hole. Insert the supplied rubber grommets into the openings at the rear wall of the housing and insert the connecting cable through these openings.

Fasten the housing bottom at the two bottom openings (Fig. 4) firmly to the cabin wall.

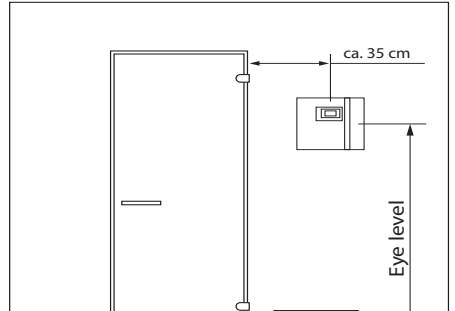

Fig. 2

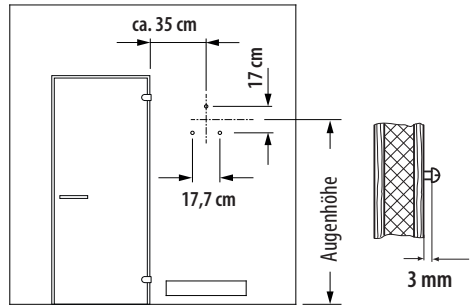
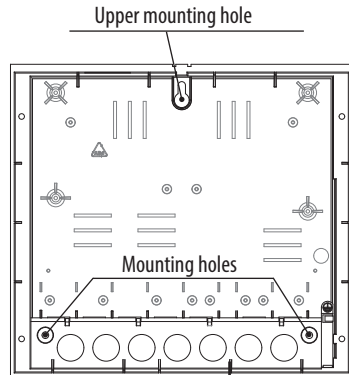

Fig. 3

Fig. 3.1



Feed-through for:

Mains cable
IR cable
Lamp

Feed-through for:

through for
sensor lines

Fig. 4

Recessed installation

1. Cut out a wall section that is at least 3.5 cm deep according to the dimension in Fig. 5.

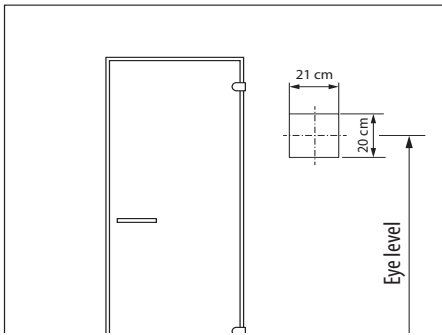

Fig. 5

Insert the supplied rubber grommets into the openings at the rear wall of the housing and insert the connecting cables through these openings.

Place the control unit into the wall opening and fasten it with 4 wood screws.

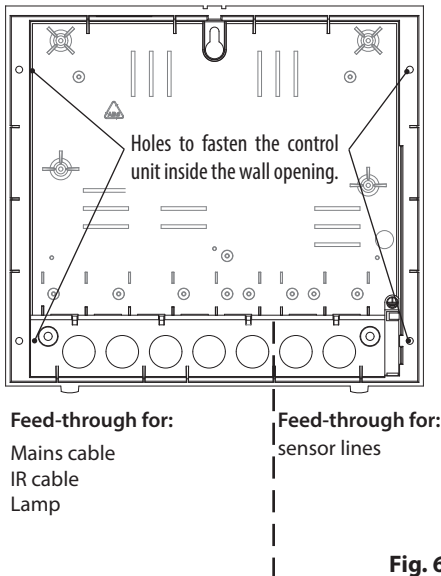

Fig. 6

Connecting the sensor cables

You should not install sensor and power supply lines together, or lead them through the same feedthrough. This can lead to interferences in the electronics, such as "fluttering" in the relays. If it is necessary to lay the cables down together, or if the line is longer than 3 m, use a shielded sensor cable (4 x 0.5 mm²).

Connect the shielding to ground in the control unit.

Please observe that the following dimensions relate to the values stipulated during the unit inspection acc. EN 60335-2-53. The heater sensor must always be installed at the point where the highest temperatures are to be expected. Illust. 7-9 give you an overview of the mounting point of the sensor.

2. Drill a hole to lead the cable through, preferably through the middle of one of the wooden boards.
3. Lead the sensor cable through the drilled hole and attach it to the sensor line according to fig. 8.
4. The cables for the temperature sensor (red) are connected to the sensor circuit board according to Fig. 9. Engage the sensor board into the casing.
5. Lead the sensor cables through the right cable intake into the control unit. Install the sensor cables inside the control unit as shown in Fig. 10. Connect the sensor cables as shown in Fig. 11. In order to do this, pull the plug **X2** from the circuit board and plug it back in after the connection.



Installation of the temperature sensor

1. The temperature sensor should be mounted on the ceiling in the middle of the cabin. See fig. 7 for details.

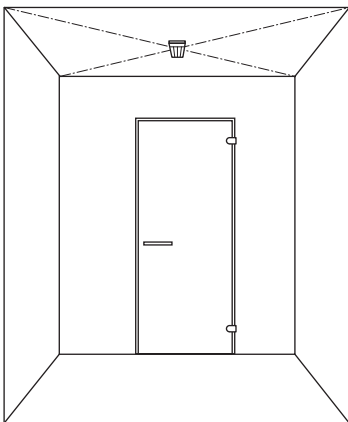

Fig. 7

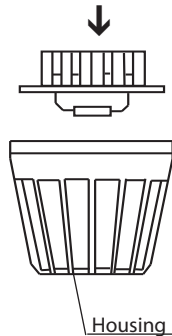

Fig. 8

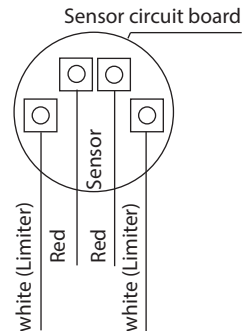

Fig. 9

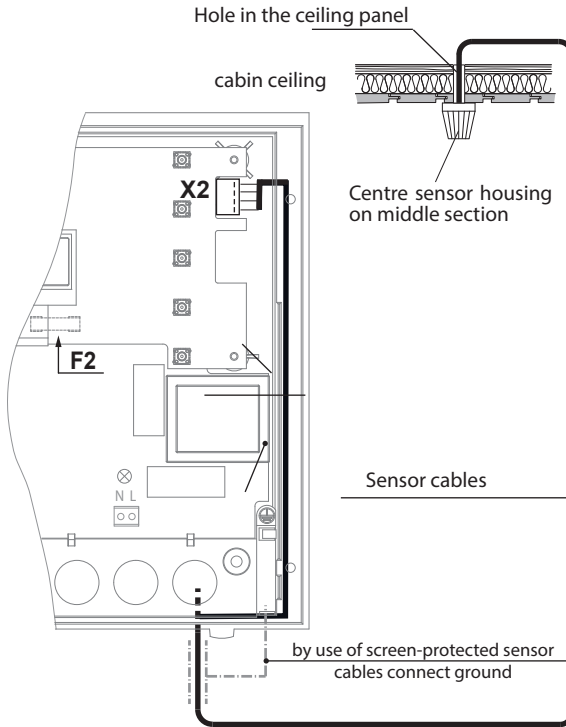

Fig. 10

Attention! Incorrect connection at the connector X2 will cause the fuse F2 to blow (see chapter „Errors“ for replacement advice).

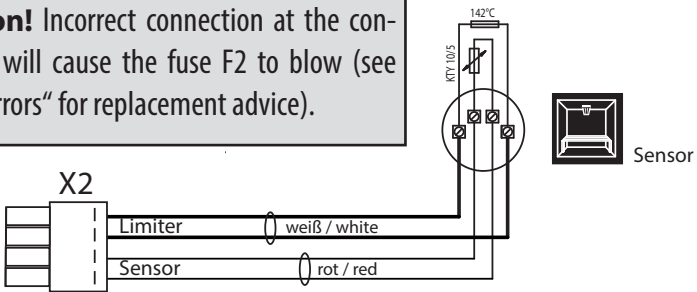
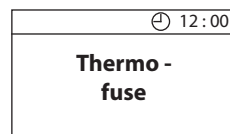

Fig. 11

6. After completed installation and correct commissioning of the control unit, the line for overtemperature protection must be checked for short-circuits. In order to do this, disconnect one of the wires of the white cable in the sensor casing. The respective error message appears in the display. Reconnect the wire to make the message disappear.



Electrical connection

The electrical connection may only be done by a certified electrician in compliance with the guidelines of the local utility company and the VDE.

In general, there should be only one permanent connection to the mains. Furthermore, equipment should be provided that makes it possible to disconnect the system on all phases from the mains with a contact opening width of minimum 3 mm.

All electrical installations and all connection lines that are installed inside the cabin must be suitable for an ambient temperature of at least 170 °C.

The power supply line is run to the control unit and connected to the power input terminals.



ATTENTION!

Swapping the phase line and neutral line will damage the control unit and can make the safety-relevant components fail.

Danger to life!



Installation of IR-radiator

- Install the IR-radiator in the cabin as per the appropriate installation manual.
- Please note that the maximal power of connected IR-radiators per phase may not exceed 3500 W.



Connecting the cabin lamp

- The cabin lamp must be suitable for the temperatures expected in the infrared cabin.
- Lay the connection cable from the control unit to the lamp through the pre-drilled hole in the cabin wall, so that the cable is not visible inside cabin. Make the connections as per connection diagram and installation guide for the lamp.
- The lamp should be installed as far as possible from the IR-radiators and may not be installed within the direct heat radiation range.
- Make sure to observe the maximum power load of the light output.

Installation diagram

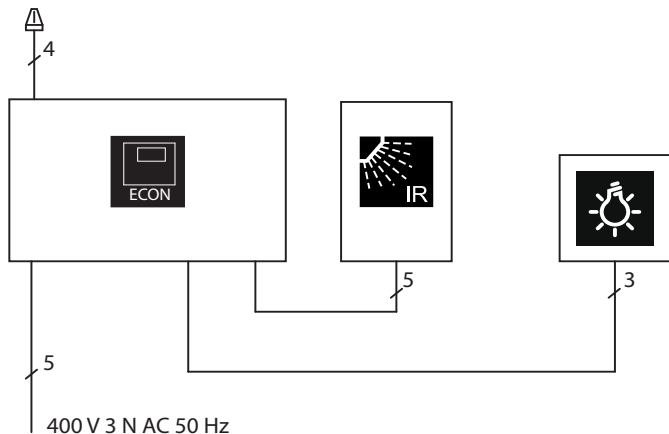

Terminal arrangement on the circuit board

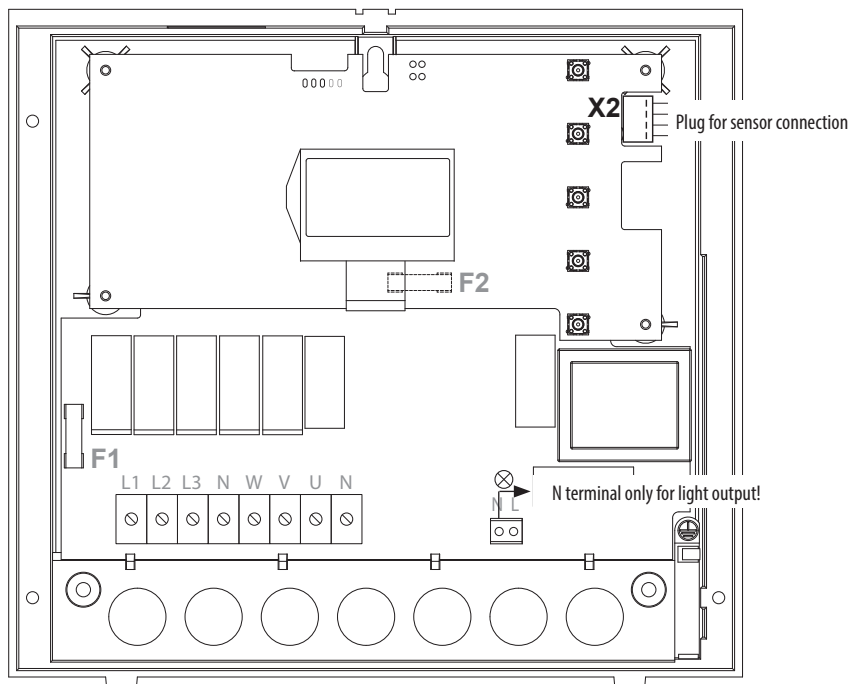

Connection diagram for IR-radiators

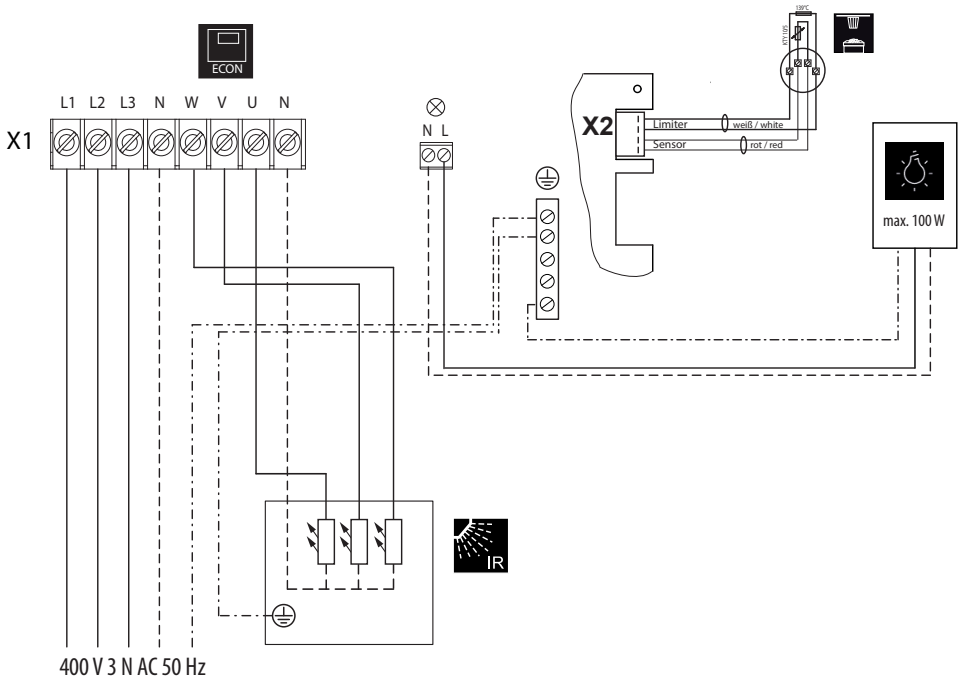

If you use this device with single phase with max. 3kW, the power supply must be connected to terminal **L1** and the load to output **U**.

Operation

Once the system has been installed with all components and the front cover has been fixed, you can put the control unit into operation.

Over the following pages we will show you the options provided to you with the control.

General information

The user interface

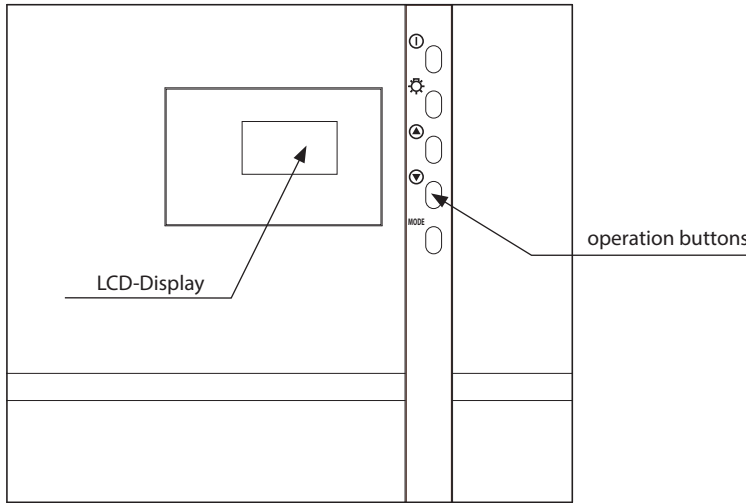



Operating buttons

 = Heating on / off (stand-by mode)

 = Cabin lighting on / off

 = Programming mode

 = Increase the value / next function

MODE  = Decrease the value / next function

Default display Stand-by

is shown if the system is in Stand-by mode.

The system also returns to this screen from other menu items, if there is no activity for >15 seconds.

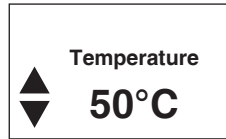

Default display in operation

is displayed when the system is operational. The display changes between the set temperature and the remaining heating time (Auto-Stop). The system also returns to this screen from other menu items, if there is no activity for >15 seconds.

Illustration of the heating performance:

During the heating phase, the thermometer fills in the right part of the display.

Once the target temperature has been reached, the thermometer is displayed as filled.

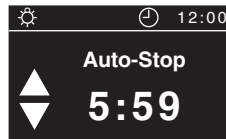
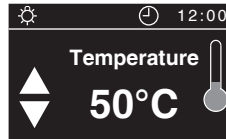

Energy-saving display

If the unit is not used, it will switch into energy-saving mode.

A moving time is shown after 5 minutes, similar to a PC screensaver. The back light for the display is switched off after an additional 15 minutes.

You can return to the basic standby screen by pressing any button.



To start heating press the On/Off button for >3 seconds.



Symbol description



The following is shown in the top area of the display:

	Light symbol	<ul style="list-style-type: none"> • Light switches on automatically when heating is switched on • Light stays on 30 min. after the heating stops • Manual light switching is possible at any time
	Clock symbol	<ul style="list-style-type: none"> • Time indication
	Clock	<ul style="list-style-type: none"> • Displays the time of day
	Keypad lock	  <ul style="list-style-type: none"> • Locks all buttons but still allows to switch off heating if the system is currently running. • Light can be still switched on and off
	Holiday home mode Holiday park mode	<ul style="list-style-type: none"> • Holiday home = symbol static, restricted access mode • Holidays park = symbol flashing, restricted access, only on/off possible

Operation principle

For settings press shortly the **MODE** -button.

Use the ▲ or ▼ - buttons to navigate to the required parameter which you would like to adjust.

Parameter values that flash on the display can be changed and are shown in this manual as displayed.

Press the **MODE** button again shortly to start the adjustment for the selected parameter.

The background of the value of the selected parameter will be flashing.

Now you can adjust this value using the ▲ or ▼ buttons.

All settings made in the standby mode should be confirmed by pressing **MODE** for >3 secs and are then saved in the current profile.

The parameter stops flashing and the new value becomes valid until it is changed again.

If no button is pressed for >15 secs, the device returns to the standard screen. Any changes made will not be saved.

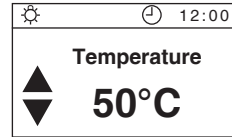

Modifiable parameter

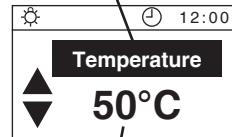

Modifiable value

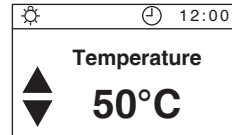

Initial commissioning

Set language (DE, GB, IT, NL, PL, RU, FR, SE, ES, CZ, FI, SLO)

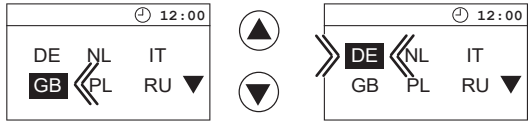

MODE
> 3 Sec

Set time of day (0:00 bis 23:59)

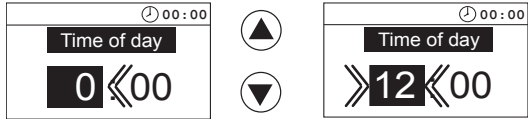

MODE

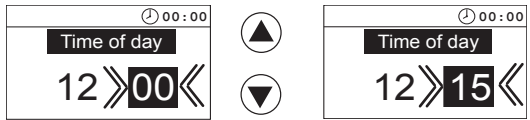

MODE
> 3 Sec

Set Life-Guard function

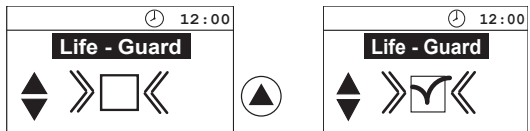

MODE > 3 Sec

Enable or disable Life-Guard

Select and confirm one of the following:

- disable, or - enable.

Switching on the IR-unit

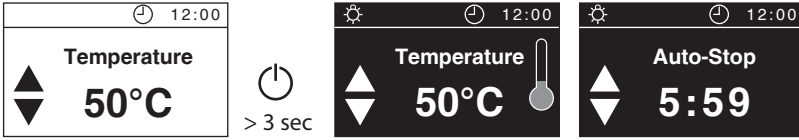

Switching off the IR-unit

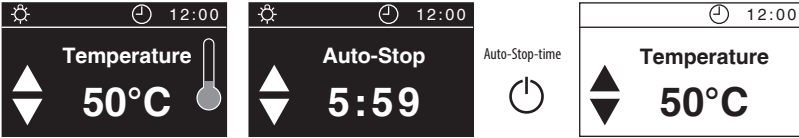

Temperature query (only when IR is on, not in stand-by.)

> 3 Sec = displays current temperature



Individual settings

The following are options for adapting the control systems to your individual needs. The parameters can be adjusted both in stand-by or in operation mode and the changes are then saved in the device. Changes made in operation mode will apply immediately, once saved.

Cabin temperature Setting range: mode 30 - 70°C

In Stand-by

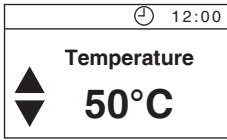

MODE

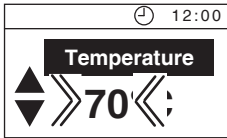
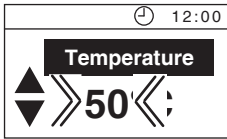

MODE > 3 sek.

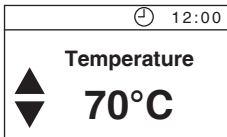

In operation

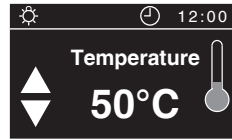

MODE

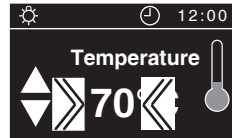
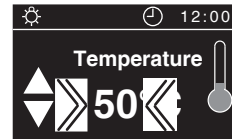

MODE > 3 sek.

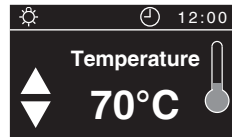

Auto-stop / heat-up time limitation

Auto-Stop defines the heating time limitation. The IR-unit automatically turns off once this time has expired.

A time between 0:30 to 12:00 can be set.

In Stand-by

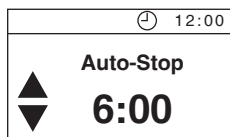
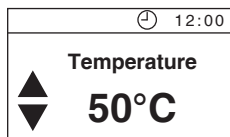

MODE

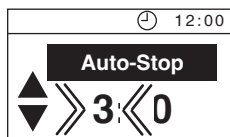
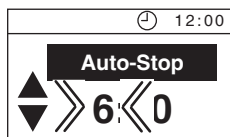

MODE

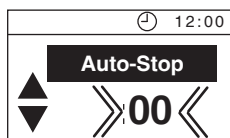

In operation

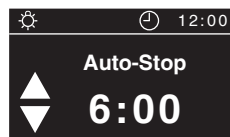
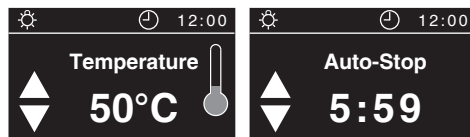

MODE

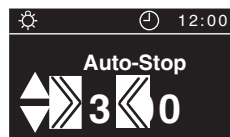

MODE

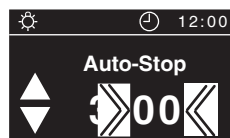

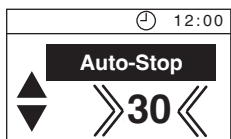

MODE > 3 sek.

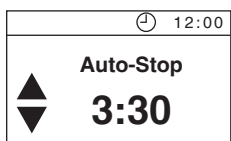

15 sek. / > 3 Sek

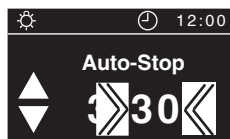

MODE > 3 sek.

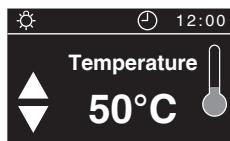
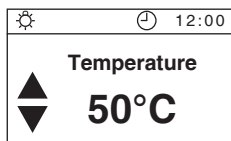
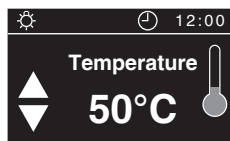

Cabin lighting

Every time that the IR system is activated, the cabin lighting is automatically switched on. The - symbol is shown at the top left of the display. If the system is switched off, the cabin lighting is also switched off after a delay of 30 minutes.

Regardless of the operational state of the IR system, the cabin lighting can be switched on or off at any time via the button.

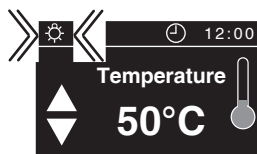

Advanced settings

Change language

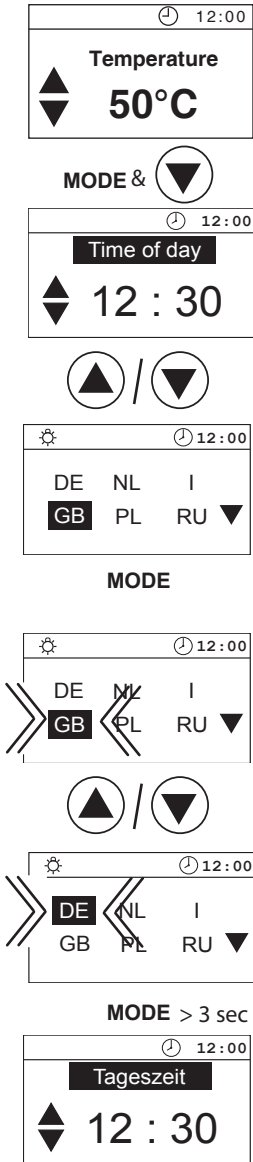

Change time

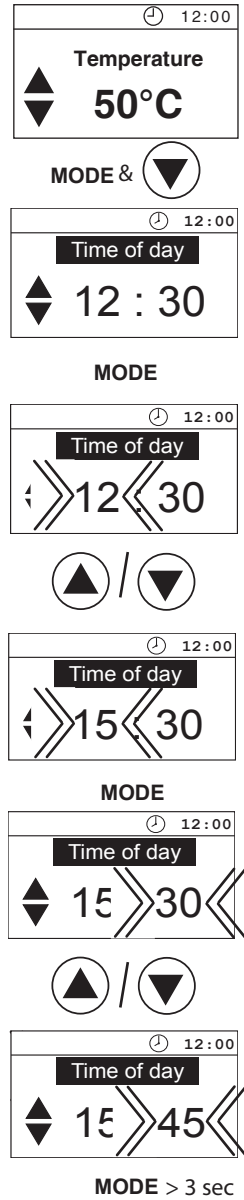

Activate / deactivate the child lock

If the child lock is activated (the key symbol is visible in the top section of the display) only the cabin lighting can be switched. All other buttons are without function. The child lock can be activated / deactivated in Stand-by as well as in operation.

The unit can still be switched off when in operation.

The mode is saved even after a switch-off.

Activate

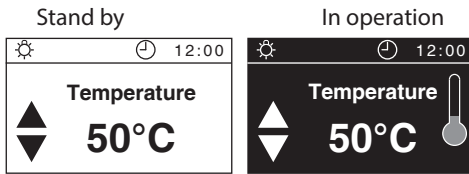

Deactivate



Activate / deactivate the Life - Guard

Life - Guard is a settable, relatively short time, e.g. 20 minutes, after which the unit is switched off, except for the cabin lighting. After this time has expired the unit can be switched on again by pushing the **MODE** button for the set time.

Activate

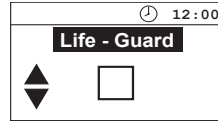
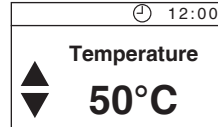

MODE

Deactivate

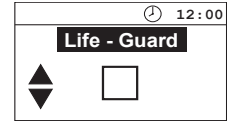
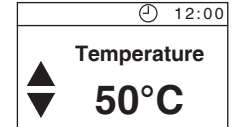

MODE

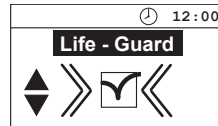
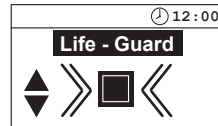

MODE > 3 Sek

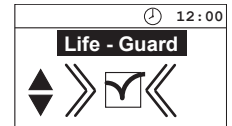
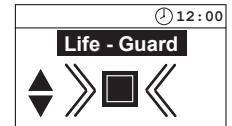

MODE > 3 Sek

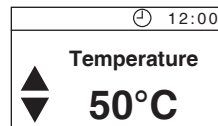

Life Guard activated

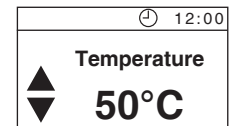

Life Guard deactivated

Life-Guard

Here you can set a short period of time after which the unit will be automatically switched off (interrupted) and may be immediately restarted for the same period of time by pressing the **MODE** button.

For example, set up 15 minutes.

If you do not press the button again after 15 minutes, the unit will switch off. After completed confirmation, it will run again for 15 minutes, etc.

The setting of the „Life-Guard“ time may be made only in stand-by mode. The „Life-Guard“ function must be activated in the basic set-up menu and shown on the display.

In stand-by

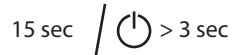
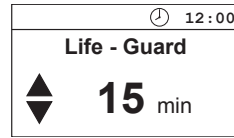
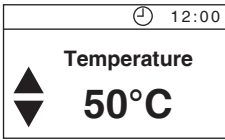

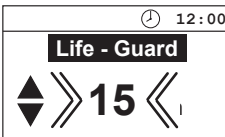
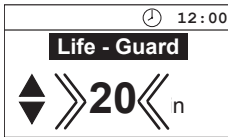

MODE

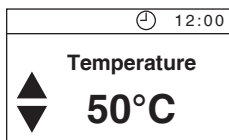

MODE

Switching on the IR unit with Life-Guard



 > 3 Sek

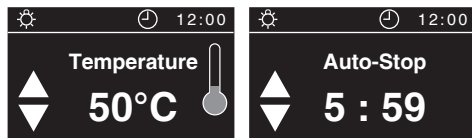

The IR-radiator is now heating normal, without "Life-Guard"-time. To activate the function "Life-Guard".

MODE

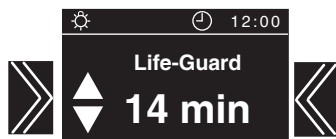

After the „Life - Guard“ - time has expired, the IR-radiator is switched off and the set „Life - Guard“ - time blinks.



Restart

MODE

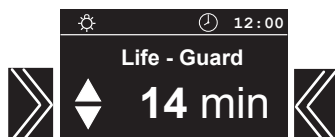

or switch off the system

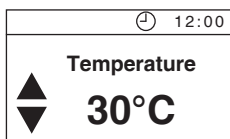

Note:

In the Life-Guard mode, no changes can be made to the temperature, if the device is operational (active heating).



Holiday home mode

The holiday home mode allows the control system to be blocked so that only the most essential functions are visible and can be set. The menu language must be selected every time before use.

The holiday home mode is activated and deactivated by keeping the keys + pressed whilst activating the system via the Switch-Off.

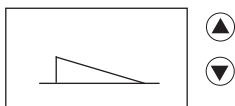

This setting is saved permanently. When the holiday home mode is active, a house symbol is permanently visible in the display.

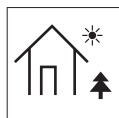

The control system functions as follows in the holiday home mode:

- The language is queried every time the control system is activated or when the system returns from the energy saving mode
- The pre-select time, life-guard, auto-stop and child lock are not available
- The configuration menu with the time, language, fan setting and life-guard is not available
- Only the temperature can be set, and the light activated

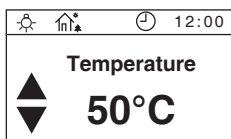

Holiday park mode

Symbol flashes

In the holiday park mode, all functions are deactivated apart from Infrared and Light (On/Off).

None of the settings, such as language, temperature, auto-stop, are available.

All values must be set before the holiday park mode is activated.

The holiday park mode is activated and deactivated by keeping the keys + Mode pressed whilst activating the system via the Switch-Off.

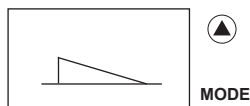

This setting is saved permanently. The house symbol in the display flashes when the holiday park mode is active.



The control system functions as follows in the holiday park mode:

- The pre-select time, life-guard, auto-stop, child lock and holiday home mode are not available
- The configuration menu with time, language and other functions is not available
- The temperature cannot be set
- The unit can only be set On/Off, and the light activated
- Light follow-up time: 10 Min.

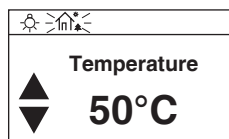

Device fuses

The control unit is fitted with two protective fuses which are mounted on the main relay board of the unit. These fuses protect the electronics on the board and the light and fan outputs.

Notice: fuses do not mean absolute protection, in an unlikely case of a power surge or a short circuit with particularly fast voltage increase the electronic components may be still be affected.

Unit fuses

F1 = T 2A H 250V Fuse electronics primary and light (*fan, if available)

F2 = T 315 mA L 250V Fuse of the electronics secondary

 Only allow a specialist to carry out this work. Before working on the open control unit, disconnect all poles from the mains. (Switch off the master switch, or trigger the FI switch). **Risk of an electrical shock!**

Loosen the four screws on the opened unit that hold the circuit board.

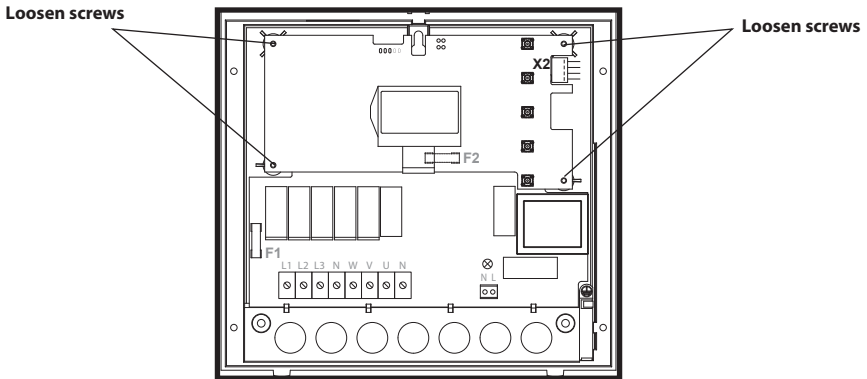

Display PCB

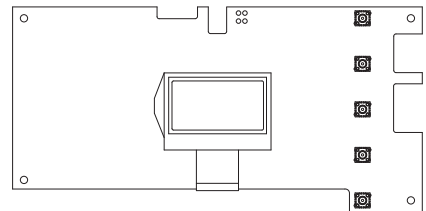

Relais PCB*

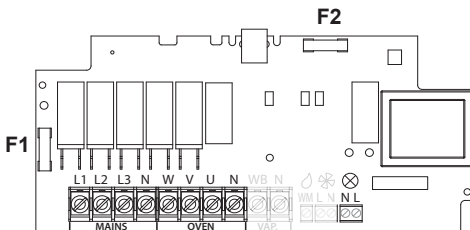

*) specific layout of the board and its components may vary slightly from model to model.

Error messages

The control unit continuously monitors the sensor for short circuits and interruptions.

The error messages appear as follows:

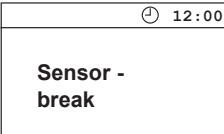
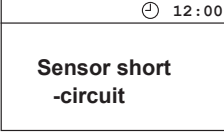
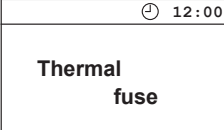
Display	Cause	Remedy
	<p>= interrupted room sensor circuit The temperature sensor (KTY) is faulty, or the line to the temperature sensor is interrupted.</p>	<p>Arrange for a specialist to check the lines and KTY. KTY at 20°C approx. 1.9 kΩ replace if necessary.</p>
	<p>= short-circuit in the room sensor circuit temperature sensor (KTY) is faulty, or the line to the temperature sensor has a short circuit.</p>	<p>Arrange for a specialist to check the lines and KTY.</p>
	<p>= interrupted limiter circuit The temperature fuse (139°C) has triggered or the line to the temperature fuse is interrupted.</p>	<p>Arrange for a specialist to check the lines and temperature fuse.</p>

The device „Switch-off“ switch

The control unit is equipped with a “Switch-off” rocker switch.

You will find this switch on the top side of the housing by Econ series control units.

This switch allows to switch the control unit to the standby mode (notice the heating will not start), to switch the control unit completely off (disconnect from power) or to switch the control unit off but to leave the light switched on.

Notice: if you leave the Econ control units switched off for more than 24 h the time setting will be lost. Other settings will be saved. You will have to repeat setup and re-confirm the settings.

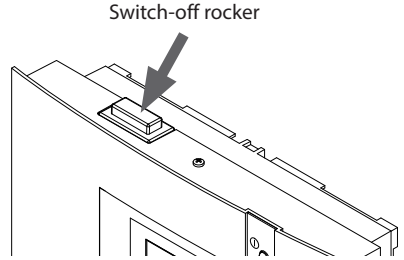

Note!

When switching the switch-off rocker from Pos. I to Pos. II, you will be at the intermediate position 0 for approx. 1s.



Attention! Parts of the printed circuit board will still remain energized in the switched off condition! Risk of electric shock!

Switch setting 0

Press the switch on the lower side of the rocker to the first latch (**switch setting 0**). The switch will be in the middle position. The unit is now completely switched off (disconnected).

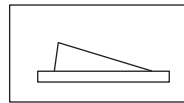

Device switched on.
(default Position I)

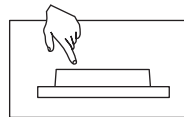

Device switched off
(completely);
Position 0.

Switch setting II

To turn the light on in the cabin while the unit is still disconnected (for maintenance and cleaning) push the left side of the rocker to the second latch (**switch setting II**).

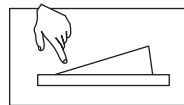

Light enabled;
Device switched off.
Position II.

Switch setting I

To make the unit ready for operation, switch back to the initial position (**switch setting I**). The unit will return to stand-by mode.

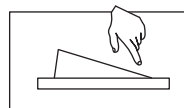

Device switched on.
Position I.

Reset control to factory settings:

Restart control via the switch-off rocker and keep the buttons **MODE**, ,  pressed. After the appearance of the picture, press the keys **MODE**,  for > 3 sec.



Recycling

Devices or lighting elements that will not be used any longer have to be handed in at a recycling station according to regulation 2012/19/EU. Do not dispose it with the normal household waste.



Service Address:

EOS Saunatechnik GmbH
Schneiderstriesch 1

35759 Driedorf, Germany

Tel: +49 (0)2775 82-514

Fax: +49 (0)2775 82-431

servicecenter@eos-sauna.de

www.eos-sauna.de

Please retain this address together with the installation guide for further references.

To help us answer your questions quickly and competently please provide the information printed on the type shield including the model, item no. and serial no., in all inquiries.

Equipment commissioning date:

Stamp and signature of the authorized electrician:

General Terms and Conditions of Service

I. Scope

Unless otherwise agreed in writing in a specific case, these terms and conditions of service shall apply to service operations, including examining and repairing complaints. All our existing or future legal relationships shall be governed solely by the following terms and conditions of service. Our recognition of any conflicting terms and conditions of the Ordering Party shall be conditional upon our having given our express written consent to their applicability. We hereby expressly object to any terms and conditions of the Ordering Party contained in its General Terms and Conditions of Business or order confirmation. If order confirmations or deliveries are accepted without reservation, this shall not be deemed to constitute recognition of such terms and conditions. Any ancillary agreements or amendments must be confirmed in writing.

II. Costs

The Ordering Party shall bear the following costs in connection with the service operation:

- De-installation/installation and electrical works (connection / disconnection).
- Transportation, postage and packaging.
- Function testing and troubleshooting including inspection and repair costs.

There shall be no third-party billing.

III. Obligations / Ordering Party's cooperation

The Ordering Party shall provide free-of-charge assistance to the manufacturer in carrying out the service operation.

In the case of a warranty claim the manufacturer shall provide the required replacement parts to the Ordering Party free of charge.

IV. Service visit by the manufacturer

In the event that it is essential that a manufacturer employ carry out the service operation on site, this must be agreed in advance. Where the main reason for the service call is not the fault of the manufacturer, any costs incurred shall be recharged to the Ordering Party after the service visit and shall be paid as per agreed payment terms.

V. Liability

The manufacturer shall assume liability in accordance with the currently applicable statutory regulations. The packaging for all of our products is designed for the shipping of individually packed goods (pallet). We expressly

point out that our packaging is not suitable for individual shipments via parcel post. The manufacturer shall accept no liability for damage incurred as a result of improper packaging in an individual shipment.

VI. Manufacturer's Guarantee

The manufacturer's guarantee shall apply only in the event that installation, operation and maintenance have been carried out in accordance with the manufacturer's specifications contained in the installation instructions and instructions for use.

- The guarantee period shall commence from the date on which proof of purchase is provided and shall be limited, in principle, to 24 months.
- Guarantee services shall be performed only if the original proof of purchase relating to the equipment can be presented.
- Any and all guarantee claims shall become void if modifications are made to the equipment without the manufacturer's express consent.
- Any guarantee claim shall likewise become void in the case of defects that arise due to repairs or interventions made by unauthorized persons or due to improper use.
- In the case of guarantee claims, the serial and article numbers must be indicated together with the product name and a meaningful description of the fault.
- This guarantee shall cover defective equipment parts, with the exception of usual wear parts. Wear parts are, among others, lamps, glass parts, heating elements and sauna stones.
- Only original replacement parts may be used within the warranty.
- Service visits by outside companies shall require a written order to be issued by our service department.
- The equipment in question shall be sent to our service department by the Ordering Party and at its expense.
- Electrical installation and connection works in the event of service or replacement shall be carried out at the Customer's expense and shall not be borne by the manufacturer.

Complaints in respect of our products shall be reported to the responsible authorized dealer and shall be exclusively handled via the latter.

The manufacturers General Terms and Conditions of Business, which can be found at www.eos-sauna.com/agb, shall apply in addition to the foregoing terms and conditions of service.

As of 08/2018