

Emotec IR

Control unit for infrared cabins

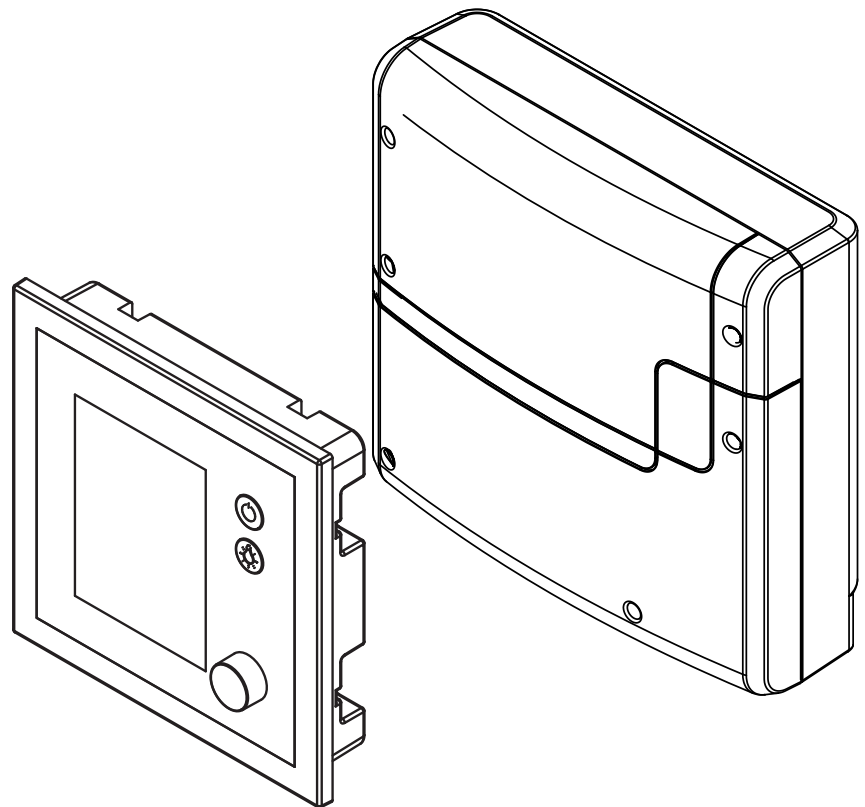

Operating Instructions

Made in Germany



Druck-Nr.: 2902 5035
Stand: 13/19

Documentation

Manufacturer

EOS Saunatechnik GmbH	
Schneiderstriesch 1	
35759 Driedorf, Germany	
Tel.	+49 2775 82-0
Fax	+49 2775 82-431
Web	www.eos-sauna.com

Original installation and operating instructions EN







Copyright for these operating instructions remains with EOS Saunatechnik GmbH.

Copyright as per DIN ISO 16016:

The copying and distribution of this document, as well as the use and communication of its contents without express authorisation, are not permitted. Compensation will be claimed in the event of infringements.

All rights reserved with regard to patent claims or submission of design or utility patent.

Characters, symbols and illustrations

-  Additional information about an operating step
-  Cross-reference to a page
-  Read instructions
-  Result of a step
-  Table title
-  Title of figure

Revision history

Date	Version	Description
26 March 2019	01.00	First version

Contents

Documentation	2
1 General safety instructions	5
1.1 Safety levels.....	5
1.2 Mounting and electrical installation	6
1.3 Operator instruction	7
1.4 Standards and regulations	9
2 Identification	10
2.1 Information about the Emotec IR control panel.....	10
2.2 Intended use.....	11
3 Description of the control panel	12
3.1 Scope of delivery.....	12
3.2 Overview of control panel	14
3.2.1 Control panel with housing	14
3.2.2 Control panel circuit board	15
3.3 Technical data	16
3.3.1 SBM-LSG-IR	16
3.3.2 EmoTec	16
4 Operation	17
4.1 Switching the system on/off.....	19
4.2 Switching the lighting on/off	20
4.3 Configuration upon commissioning or after a reset	21
4.4 Adjusting the IR emitters.....	24
4.5 Basic settings	25
4.5.1 IR operating mode	27
4.5.2 IR temperature	28
4.5.3 IR intensity	29
4.5.4 Automatic start time.....	30
4.5.5 Dimming the cabin lighting.....	32
4.5.6 One-time heating period	33
4.5.7 Recurring heating periods	36
4.5.8 Switching ECO mode on/off.....	41
4.6 Advanced settings	43
4.6.1 Screen saver	44
4.6.2 Standby mode.....	45
4.6.3 Operational lock/child lock	46
4.6.4 Heating period – auto stop	49
4.6.5 Operating data	51
4.6.6 Display brightness.....	55
4.6.7 Holiday cottage mode	56

4.7	Troubleshooting	59
5	Service settings	60
5.1	Service level	61
5.1.1	Opening service settings.....	62
5.1.2	Service/maintenance.....	63
5.1.3	Switching hysteresis for the IR temperature.....	63
5.1.4	Reset function	65
5.1.5	Temperature control.....	66
5.1.6	Configuring the channel groups	67
5.1.7	Setting the ECO runtime	70
5.2	Defining the light source manually	71
5.3	Heating period limiter	74
5.4	Updating firmware	75
6	General terms and conditions of service	79
7	Disposal	82

1

General safety instructions

1.1 Safety levels

Safety instructions and important operating instructions are classified according to ANSI Z535.6. Please familiarise yourself with the following terms and symbols:

⚠ DANGER

Danger

Indicates a hazardous situation which, if not avoided, will result in death.

⚠ WARNING

Warning

Indicates a hazardous situation which, if not avoided, could result in death or serious injury.

⚠ CAUTION

Caution

Indicates a hazardous situation which, if not avoided, could result in minor or moderate injury.

NOTICE

Notice

Indicates a hazardous situation which, if not avoided, will result in damage to the unit.

General safety instructions

1.2 Mounting and electrical installation



These installation instructions are intended for qualified personnel familiar with the laws and regulations applicable to electrical installations at the installation site. Observe the following general safety instructions during assembly, setup and commissioning.

Risk to life and limb and risk of fire

Risk to life and limb from electric shock and fire in the event of improper or faulty electrical connection. This risk also applies following completion of the installation work.

- ▶ The electrical installation of the relay box and other electrical systems or equipment with a fixed mains connection must only be performed by a trained electrician from an authorised electrical company.
- ▶ Observe the stipulations in VDE 0100 part 701.
- ▶ The system must be disconnected and removed entirely from the mains supply before commencing installation and repair work.
- ▶ The housing cover must only be removed by a specialist.
- ▶ Do not install the control panel, relay boxes or modules in enclosed cabinets or wood panelling.

Fire hazard from overheating

Infrared emitters and heating foils without overheat protection can lead to overheating of the cabin and fire. Flammable parts must not exceed a temperature of 140°C when the unit is operated as intended or in the event of a malfunction.

- ▶ Install only infrared emitters or heating foils that are designed and installed in such a way that they do not pose a fire hazard when the unit is operated as intended. Alternately, infrared emitters or heating foils with overheat protection as per EN 60335-2-53 may be used.
- ▶ Install a safety temperature limiter if needed.
- ▶ Observe the manufacturer's safety and installation instructions for infrared emitters and heating foils.
- ▶ Observe the cabin manufacturer's safety and installation instructions.

Damage due to incorrect mounting location

The control panel is not suitable for outdoor use.

- ▶ It must be operated only inside buildings and may not be exposed to environmental conditions such as extreme humidity and moisture or the possible formation of condensation or corrosive substances in the ambient air, as well as other weather conditions.
- ▶ Similarly, excessive cold and extreme exposure to sunlight must be prevented.
- ▶ Protect the unit accordingly if there is an increased risk of mechanical damage.

1.3 Operator instruction

The operator of the infrared or sauna cabin must be instructed in the general safety instructions during commissioning. The operator must be given a copy of the instructions for use.

Risk of electric shock

A risk to life and limb from electric shock and fire arises in the event of improper repair work. This risk also applies after work is completed.

- ▶ The housing cover must only be removed by a specialist.
- ▶ Repairs and installations must only be performed by a trained specialist.
- ▶ The system must be disconnected and removed entirely from the mains supply before commencing repair work.
- ▶ Use only original spare parts from the manufacturer.

Risk of burns and chemical burns

Touching hot parts may lead to skin burns and chemical burns of the skin.

- ▶ The operator must be familiar with the unit's hot parts and be able to identify them.
- ▶ The operator must be familiar with the settings for the heating period and understand how it is controlled.

Health risks

Spending time in an infrared or sauna cabin can lead to serious health risks or even death for persons with health impairments.

- ▶ Persons with health impairments who spend time in a sauna must consult a doctor before entering an infrared or sauna cabin.

General safety instructions

Equipment damage due to overuse

Excessive humidity in commercial infrared or sauna cabins can lead to property damage.

- ▶ In a commercial infrared or sauna cabin, the heating period must be set so that it switches off automatically after a specific period of time.
- ▶ If the heating does not switch off automatically after a defined heating period, cabin use must be supervised at all times.
- ▶ Inspect the cabin before each use.

Operation by children or persons with reduced mental capacity

Children and persons with reduced mental capacity can be a risk.

- ▶ Children must be supervised to ensure they do not play with the unit.
- ▶ Children under 8 should not operate the infrared cabin.
- ▶ The settings for the heating period must only be used by children under 8 years of age if they are supervised by an adult.
- ▶ The infrared cabin must only be used by persons with reduced mental capacity, or limited physical or sensory abilities under supervision or if they have already been instructed in its use and understand the risks.
- ▶ Children and persons who have not received proper instruction must not clean or service the system.

1.4 Standards and regulations

The following standards, in their currently applicable versions, were observed during design and construction.

Local regulations also apply to the installation and operation of heating, sauna, and steam room systems.

Standard	Title
DIN EN 60335-1	Household and similar electrical appliances – Part 1: General requirements
DIN EN 60335-2-30	Household and similar electrical appliances – safety – Part 2-30: Particular requirements for room heaters
DIN EN 60335-2-53	Household and similar electrical appliances – safety – Part 2-53: Particular requirements for sauna heating appliances and infrared cabins
DIN EN 60335-2-96	Household and similar electrical appliances – safety – Part 2-96: Particular requirements for heating equipment
DIN EN 55014-1	Electromagnetic compatibility – Requirements for household appliances, electric tools and similar apparatus – Part 1: Emission
DIN EN 55014-2	Electromagnetic compatibility – Requirements for household appliances, electric tools and similar apparatus – Part 2: Immunity

2

Identification

This chapter describes the control panel. For a detailed description of the SBM-LSG-IR, please refer to the installation instructions.

The Emotec IR control panel is available in the following colour models:

- Anthracite/silver
- White/silver

Software version R. 3.50 or higher must be installed in the control panel. Update your software if it does not match the specifications above.

See:

- 4.6.5 Operating data, [51](#)
- 5.4 Updating firmware, [75](#)

2.1 Information about the Emotec IR control panel

Nameplate

The nameplate is located on the inside of the front panel next to the circuit board.

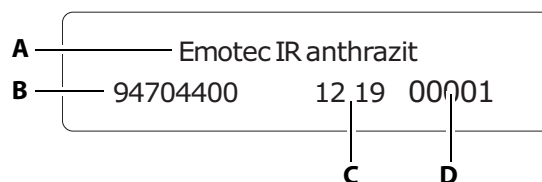

- | | |
|--------------------------------|-----------------------------|
| A Name and colour model | C Manufacturing date |
| B Item number | D Serial number |

 EmoTec IR nameplate (example)

Requirements for operation and storage

The Emotec IR is only intended for installation outside the infrared cabin. The mounting location must meet the following climate condition requirements:

- Ambient temperature during operation -10°C to 40°C
- Storage temperature -20°C to 60°C

2.2 Intended use



The control panel is not suitable for outdoor use.

It must be operated only inside buildings and may not be exposed to environmental conditions such as extreme humidity and moisture or the possible formation of condensation or corrosive substances in the ambient air, as well as other weather conditions. Similarly, excessive cold and extreme exposure to sunlight must be prevented. Protect the unit accordingly if there is an increased risk of mechanical damage.

SBM-LSG-IR

The SBM-LSG-IR is designed to operate infrared radiators and foils (IR emitters).

Emotec control panel

The Emotec IR control panel is suitable for private and commercial use to control infrared and sauna cabins. It must be mounted on a wall.

Foreseeable misuse

The following are considered instances of foreseeable misuse:

- The infrared heating foils do not have an integrated temperature sensor with overheat protection.
- The control and sensor cable plugs are plugged in incorrectly.
- The cabin addresses are programmed incorrectly.
- The unit is operated without knowledge of or compliance with the safety instructions.
- Operating, service and maintenance requirements are not observed.
- The unit is operated after technical or other modifications are made to the module.
- The unit is operated by children or persons with reduced mental capacity or by persons who have not been thoroughly instructed in its use.

 General safety instructions,  5

For more information, see the Emotec IR installation instructions.

Description of the control panel

3

Description of the control panel

The Emotec IR control panel is designed to control infrared cabins. To do so, the SBM-LSG-IR is required. It is controlled by the control panel.

In addition to the temperature sensor, various add-on modules can be connected to the infrared cabin and controlled by Emotec IR.

3.1 Scope of delivery

The complete scope of delivery is described in the installation instructions. The following components are important for operation:

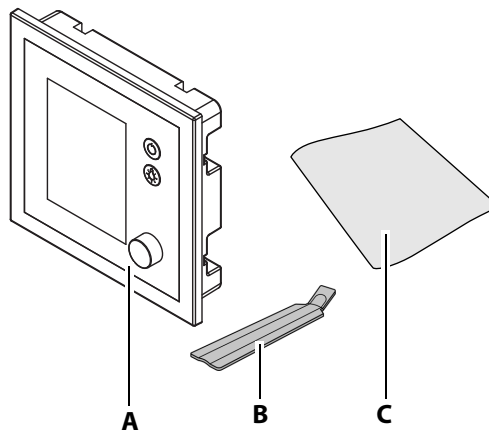

- A** Emotec control panel – front panel with housing
- B** Removal tool
- C** Operating instructions
- ☒ Emotec IR scope of delivery – control panel

Check the scope of delivery for completeness.

Accessories (optional)

Accessories	Item no.
20 m connecting cable for temperature sensor	94.6281
50 m connecting cable for temperature sensor	94.6282
10 m connecting cable for control panel (RJ10/RJ14)	94.6802
25 m connecting cable for control panel (RJ10/RJ14)	94.6285
50 m connecting cable for control panel (RJ10/RJ14)	94.6968
100 m connecting cable for control panel (RJ10/RJ14)	94.6969
10 m connecting cable for sauna bus (RJ12/RJ12)	94.5861
25 m connecting cable for sauna bus (RJ12/RJ12)	94.4647
50 m connecting cable for sauna bus (RJ12/RJ12)	94.4648
IR module as installation add-on	94.6966
IR plug-in module with adapter cable	94.2046
IR plug-in module without adapter cable	94.4960
2.5 m connecting cable for IR plug-in module	94.4396
Set SBM ECO push button	94.6980
SBM-WCI-01 web app module	94.5987
SBM remote start	94.5782
SBM-FL75/150 coloured light module	94.5996, 94.6007
SBM-S BT sound module	94.5921
Infrared receiver for coloured light module and sound module	94.6810
SBM-GLT-MOD HOME Modbus module	94.7077
SBM-GLT-KNX HOME KNX module	94.7078
Modular distributor RJ12 for connecting cable for control panel and sauna bus	2001.5298

Description of the control panel

3.2 Overview of control panel

The control panel consists of a display with a circuit board and is enclosed in a plastic housing. The housing completely encloses the circuit board and the electronics.

3.2.1 Control panel with housing

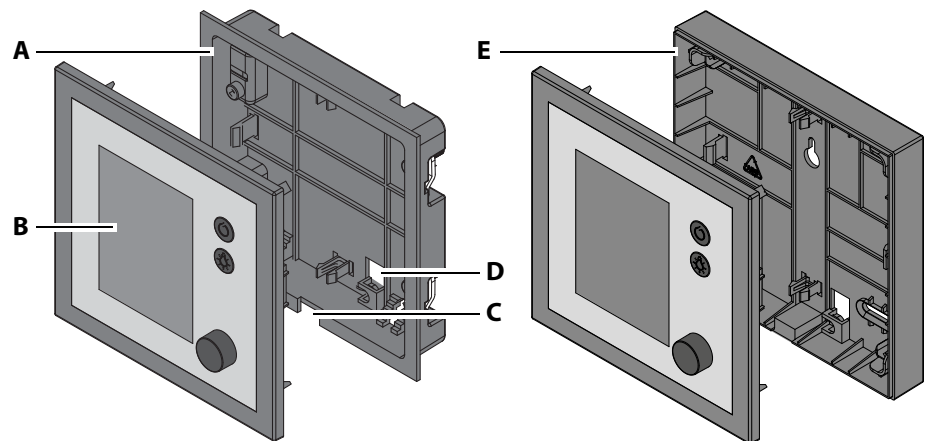

A Housing for flush-mounting installation
B Front panel with display

C Slot at base for removal tool
D Opening for sauna bus connection
E Housing for surface-mounting installation

 Emotec IR diagram

The control panel has two installation options::

- Flush-mounting installation (**A**): The housing is mounted in the wall.
- Surface-mounting installation (**E**): The housing is mounted on the wall.

The connecting cable for the relay box is fed through the back of the housing. The circuit board is built in the control panel housing.

3.2.2 Control panel circuit board

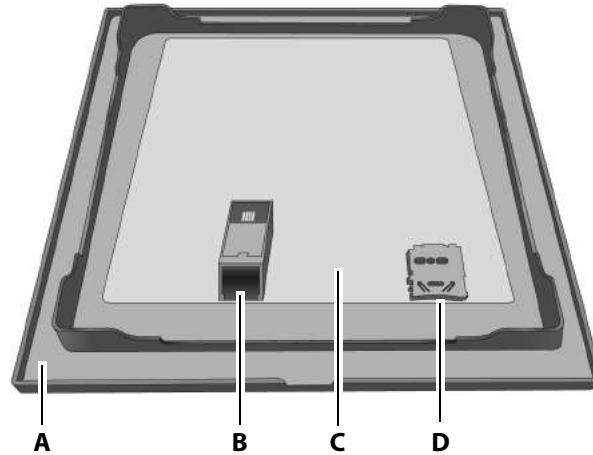

- A** Front panel – back
 - B** Sauna bus connection
 - C** Circuit board (diagram)
 - D** Memory card (microSD) connection
-  Emotec IR circuit board connections

Description of the control panel

3.3 Technical data

3.3.1 SBM-LSG-IR

Ambient temperature	-10°C to +40°C
Storage temperature	-20°C to +60°C
Relay box housing	Plastic
Dimensions (H x W x D)	240 x 230 x 70 mm
Weight	Approx. 1.5 kg
Control panel	Emotec IR
Outputs/inputs	3 x RJ10 jack for sensor connection 2 x RJ12 jack for control panel and add-on modules Input for power supply plug
Power supply	230 V 1N AC 50 Hz
Switching output	Max. 3.5 kW
Circuits	3 separate circuits with total output of 3.5 kW, can be freely defined - 2 of which individually dimmable - 1 of which non-dimmable switching output
Temperature control	Based on ambient temperature: 30-70°C Based on personal preference using dimmable channels (zones)
Control characteristics	Digital output control on circuits 1 and 2
Connection for lighting	Min. 5 W (20 mA), resistive load, max. 100 W Dimmable energy-saving bulbs, max. 35 W Light source with conventional transformers, max. 60 VA Use only dimmable light sources.
Sensor system	Digital sensor for ambient temperature
Heating period limiter	Up to 6 hrs/12 hrs/infinite

3.3.2 EmoTec

Ambient temperature	-10°C to +40°C
Storage temperature	-20°C to +60°C
Housing	Plastic
Control panel dimensions (W x H x D)	127 x 130 x 25 mm, mounting depth approx. 20 mm
Display	TFT colour display 55 x 74 mm (3.5" diagonal)
Control panel outputs/inputs	1 x RJ10 jack for relay box 1 x connection for memory card (microSD memory card reader)
Operation	Buttons for on/off and lighting, jog dial

4

Operation

All cabin settings are made at the control panel.
 All functions must be configured to commission the system.
 Add-on modules or accessories are detected after the unit is switched on again and their corresponding icons appear in the sub-menus.

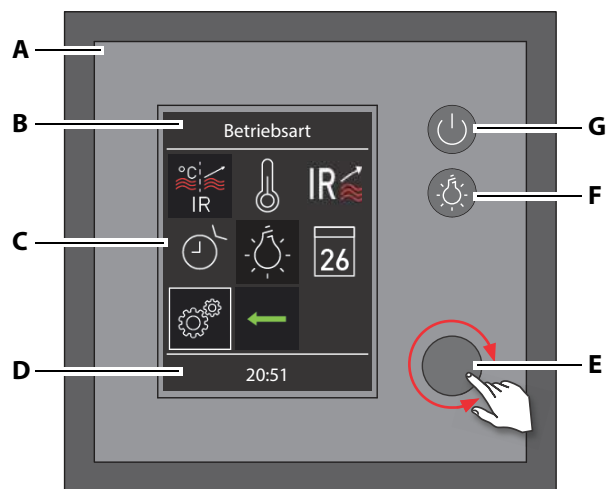

- A** Front panel
 - B** Selected function
 - C** Function icons
 - D** Status bar
 - E** Jog dial
 - F** Switch cabin lighting on/off
 - G** Switch on/off
-  Emotec control panel

Operation

Controls

The following controls are used to operate the unit:



On/off
Close sub-menu

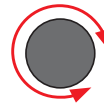

Jog dial:
Turn = select functions or input value



Lighting on/off



Jog dial:
Press = confirm functions and settings.

- Selected icons are displayed inside a white frame. Once the selection is confirmed, the frame turns green and the display now shows the selected function.
- When a value is entered, a line appears under the active place value. Confirmed values are displayed in green.

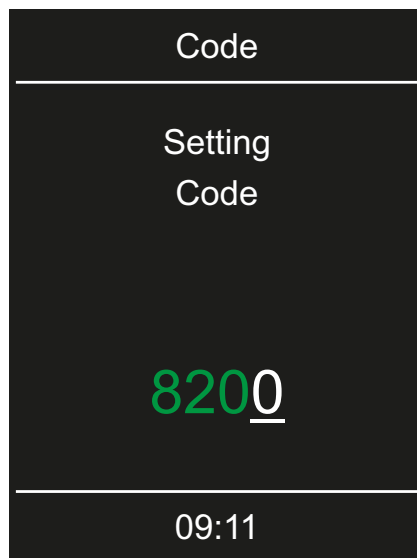

Example – Entering values

The standby screen appears after the jog dial has not been touched for 15 seconds.

- Settings that have not been saved are lost.
- Date and time are saved if the built-in battery is in working order. All other settings are saved permanently.

4.1 Switching the system on/off

You can switch the system on or off manually at any time. If the display is blank, it means that the relay box is not switched on. An on/off switch is located on the left side of the relay box.

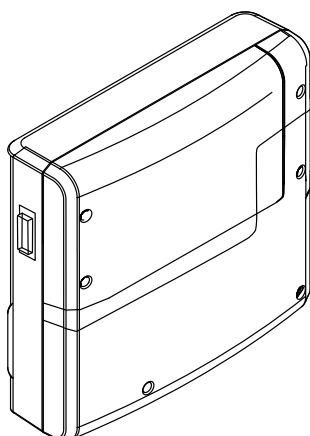

Position I:
Relay box is switched on.
The relay box is ready for operation in standby mode.



Position 0:
Relay box is completely switched off.
Parts of the circuit board are still energised.



Position II:
Cabin lighting is switched on, relay box is switched off.
Position for maintenance and cleaning.

► Switching the system on

- 1  : Press and hold for approx. 3 seconds until the cabin is switched on.

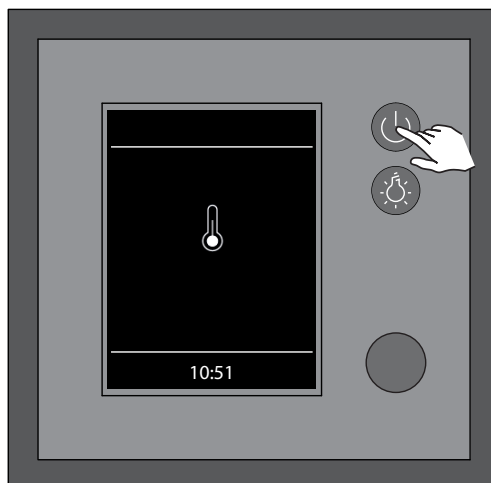

- ① The cabin is switched on with the pre-set parameters after the countdown.

► Switching the system off

- 1 Press .

4.2 Switching the lighting on/off

Lighting can be mounted anywhere. The light output is set to inductive load by default, to which resistive loads may also be connected. If required, the light output can also be manually set to capacitive loads.

Cabin lighting is not included in the scope of delivery. Observe the separate installation instructions for lighting.

Lighting requirements

- Lighting must be dimmable
- Minimal output 5 W
- Resistive loads max. 100 W
- Dimmable energy-saving bulbs max. 35 W
- Light sources with conventional transformers max. 60 VA
- Dimmable LED bulbs max. 60 W

NOTICE

Material damage

Lighting and the control panel could become damaged if non-dimmable light sources are installed. In this case, the warranty becomes void.

- ▶ Do not install lighting in the emitting range of an IR emitter.
- ▶ The lighting must conform to protection class IPX4 (splash-proof) and be resistant to ambient temperatures.
- ▶ Connect only dimmable light sources.

Setting the light output, see 5.2 Defining the light source manually, [71](#).

► Switching the system on

- 1 Press .

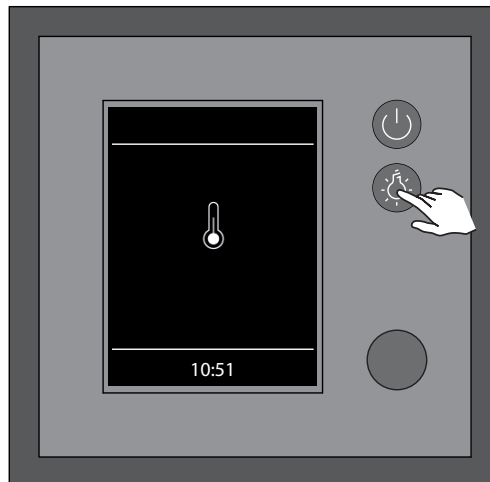

► Switching the system off

- 1 Press .

4.3 Configuration upon commissioning or after a reset

The settings must be redefined upon commissioning and after a complete system reset. The program guides you through the required steps.

► Defining the user interface language

- 1 Select a language and confirm.



► Setting the time

- 1 Set the hour and confirm.

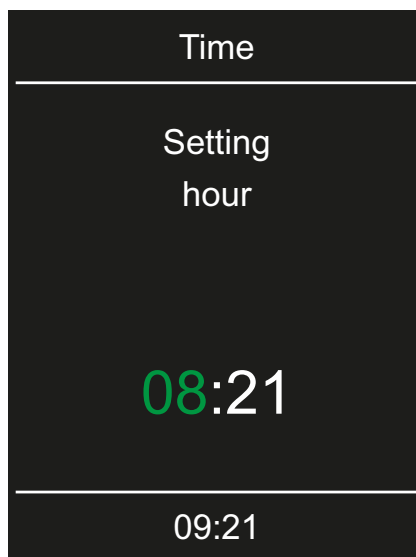

- ⓘ A line appears under the active place value.
- ⓘ The confirmed place value appears green.

- 2 Set the minutes and confirm.

► Setting the date

- 1 Set the year, month and day and confirm your settings.

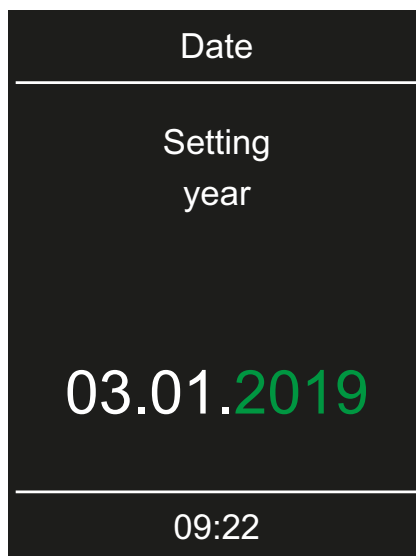

- ⓘ Once a setting is confirmed, the next place value is selected.

► Defining the type of use

1 Select the type of use and confirm.

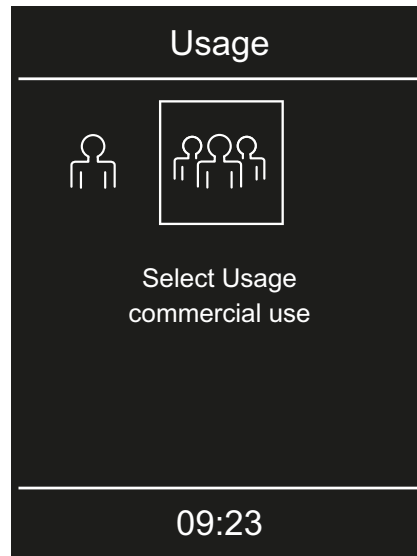

a)  Private use

b)  Commercial use

① Special safety regulations apply to the commercial setting. See 1.3 Operator instruction, [p 7](#)

This completes configuration of the IR cabin. The standby screen is displayed once configuration is complete.

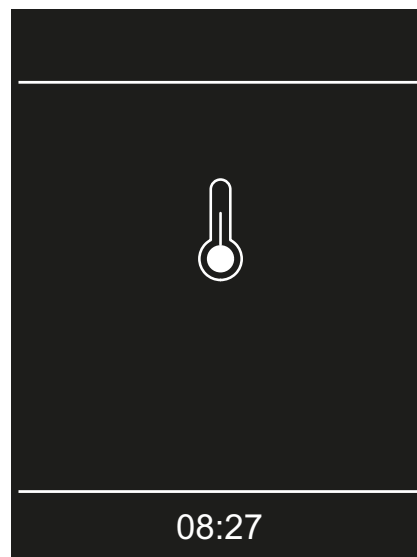



You must now set the channel groups and operating mode for infrared operation.

- ► Configuring the IR channel groups, [p 68](#)
- ► Setting the operating mode, [p 27](#)

4.4 Adjusting the IR emitters

The IR emitters have two operating modes.

These operating modes let you determine how the IR emitters can be used: via intensity and/or temperature.

Operating mode	Temperature	Intensity
	Ambient temperature can be set via temperature sensors Emitters heat until the temperature has been reached	All channel groups at 100%
	Ambient temperature increases slowly via channel group intensity	Can be set for each channel group

IR intensity operating mode

The following settings are available in IR intensity operating mode for outputs IR-1 to IR-3:

Foils at IR-3	Emitter at IR-3	Foil at IR-1, IR-2	Emitter at IR-1, IR-2	Intensity setting
	x			0% or 100%
x		x		20% to 100%, in increments of 2%
			x	15, 25, 33, 50, 66, 75, 100%

IR temperature operating mode

The following settings are available in IR temperature operating mode for outputs IR-1 to IR-3:

Foil at IR-1, IR-2, IR-3	Emitter at IR-1, IR-2, IR-3	Control mode for relay output
x	only IR-1 and IR-2	Control via T (target)
	x	Switch-off > 70°C

The connection for switching output IR-3 is not controlled via the temperature of the IR emitter in Emitter operating mode, but rather is switched off when the ambient temperature reaches 70°C. In Foil operating mode, it is controlled via the ambient temperature sensor.

Note that the intensity and temperature settings impact the duration of the heat-up phase.

4.5 Basic settings

Add-on modules or accessories are detected after the unit is switched on (again) and their corresponding icons appear in the sub-menus. For information on the settings for these modules, please refer to the relevant operating instructions.

You can change the current settings while the system is in operation.

In addition to cabin-specific settings, the following settings are also available: one-time and recurring heating periods and remote control functions, such as remote start, app, home.

The following descriptions apply to both private and commercial operation.

Menus

The display switches to standby mode if there is no activity for 15 seconds. You can cancel standby mode by turning the jog dial.

Standby mode is indicated by one of the following icons depending on the operating mode.

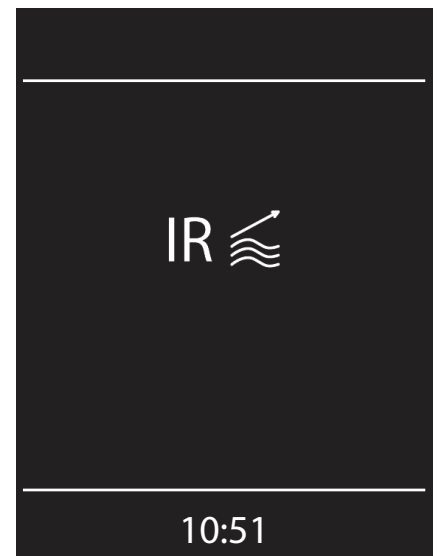

 Standby mode

Operation

Main menu settings

The following icons appear in the main menu, depending on the installation.

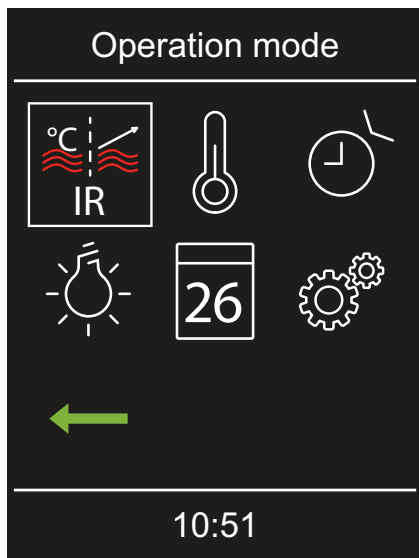

Icons

The icons displayed depend on the operating mode currently in use.



IR operating mode selection
4.5.1 IR operating mode, [p 27](#)



IR temperature
4.5.2 IR temperature, [p 28](#)



IR intensity
4.5.3 IR intensity, [p 29](#)



Auto start
4.5.4 Automatic start time, [p 30](#)



Light
4.5.5 Dimming the cabin lighting, [p 32](#)



Timer
4.5.6 One-time heating period, [p 33](#)
4.5.7 Recurring heating periods, [p 36](#)



Settings
4.6 Advanced settings, [p 43](#)



ECO mode
4.5.8 Switching ECO mode on/off, [p 41](#)



Back

When the system is switched off, you can close a sub-menu by pressing



4.5.1 IR operating mode

These operating modes allow you to determine how the IR emitters can be used: via intensity and/or temperature.



See 4.4 Adjusting the IR emitters, [p 24](#)

► Setting the operating mode

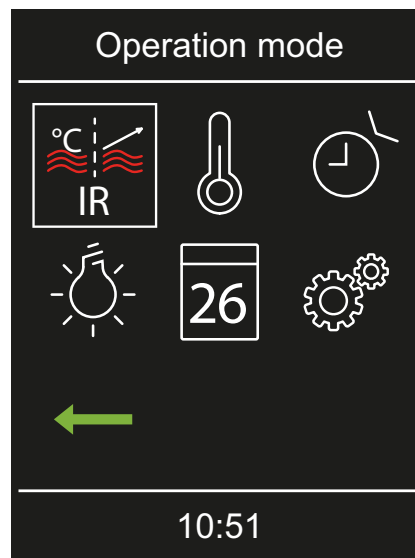
- 1  : Select and confirm.



- 2 Select the IR operating mode and confirm.

- a)  IR temperature. In this operating mode, both the IR temperature and the intensity of the IR emitters can be set.
 - b)  IR intensity. In this operating mode, only the intensity of the IR emitters can be set.
- ① Depending on the IR operating mode you select, you can now set the temperature and/or intensity.

4.5.2 IR temperature

You can set the temperature only after you have selected the IR operating mode for temperature.

See 4.5.1 IR operating mode, [p 27](#)

► Setting the IR temperature

- 1  : Select and confirm.

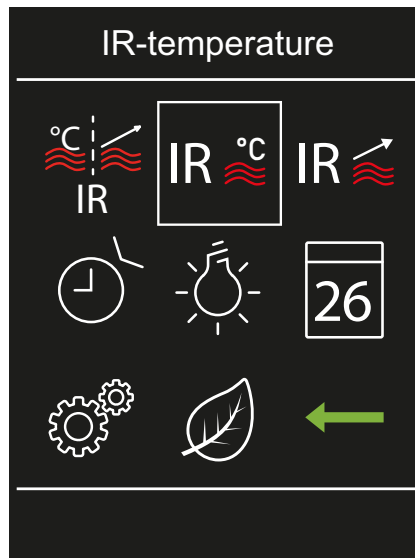

- 2 Set the temperature and confirm.

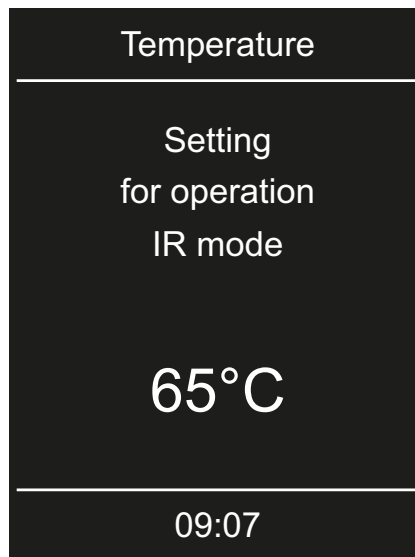

- 3 Confirm the set value.
 - The value is saved and the display returns to the screen for operating mode selection.

4.5.3 IR intensity

You can set the intensity only after you have defined the channel groups. See 5.1.6 Configuring the channel groups, [p 67](#)

► **Setting the IR emitter intensity**

- 1 : Select and confirm.

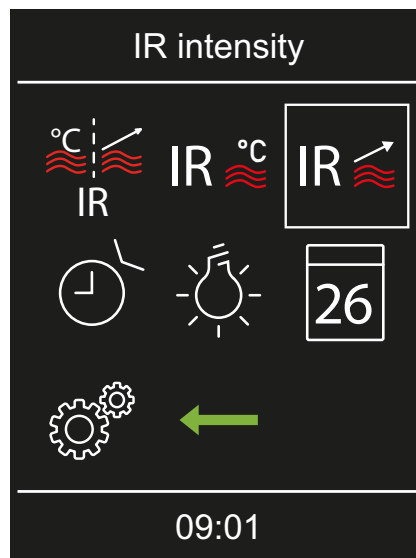

- 2 Select the channel and confirm.

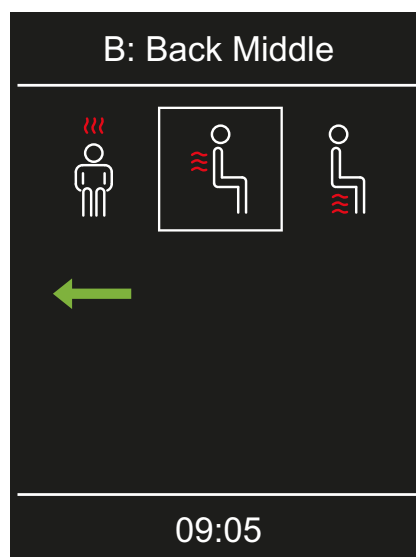

- 3 Set the IR emitter intensity.

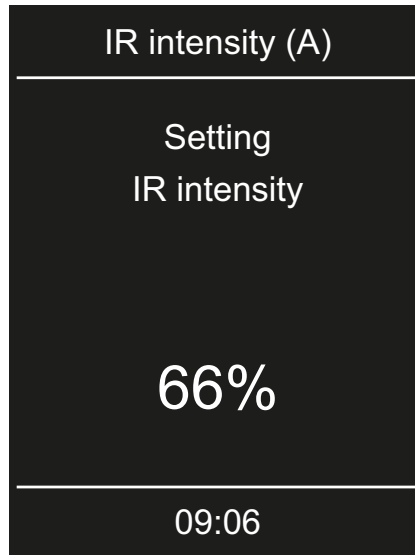

- ⓘ The value can be set in increments of 2% between 20% and 100%.
 - ⓘ IR-3 connection:
For emitters, you must select either 0% or 100% as the intensity.
The selected intensity for foils may be selected in increments of 2% between 20% and 100%.
- 4 Confirm the set value.
 - The value is saved and the display returns to the screen for operating mode selection.
 - The channel group emitters are immediately set to the new intensity. This means the emitters for this channel group are not set to the target temperature.
 - 5 Repeat steps 1 to 4 for the next channel.

4.5.4 Automatic start time

This function allows you to set the automatic start time up to 24 hours in advance.

- ▶ Setting the automatic start time, [p 31](#)
- ▶ Deleting the start time, [p 32](#)

► Setting the automatic start time

- 1  : Select and confirm.

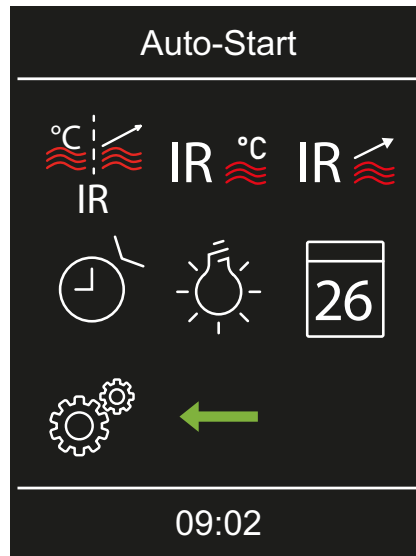

- 2 Set the hours and minutes and confirm.

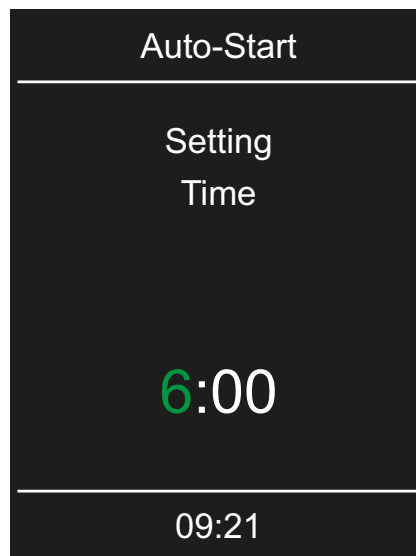

- ① A line appears under the active place value. Confirmed numbers are displayed in green.
- ① The start time flashes in the status bar next to the time.

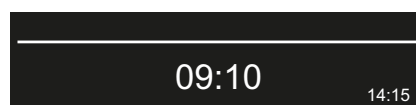

► Deleting the start time

- 1 Press .
Alternately, you can set the time to --:--.
► Setting the automatic start time, [p 31](#)

4.5.5 Dimming the cabin lighting

The lighting is dimmed only if the cabin is switched on. If the cabin is switched off, you can switch on the light for cleaning purposes at the relay box by choosing setting II on the switch.

See:

- 4.1 Switching the system on/off, [p 19](#)
- 5.2 Defining the light source manually, [p 71](#)

► Setting the brightness of the cabin lighting

- 1  : Select and confirm.

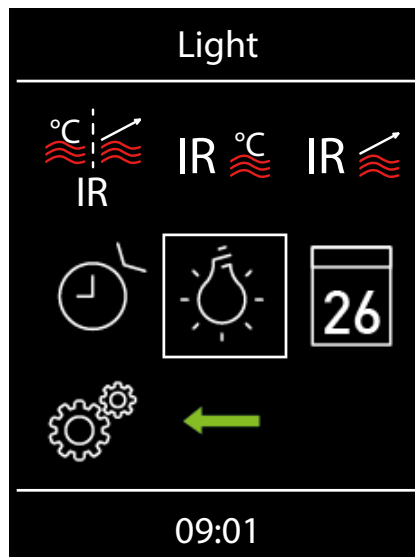

2 Set the brightness and confirm.

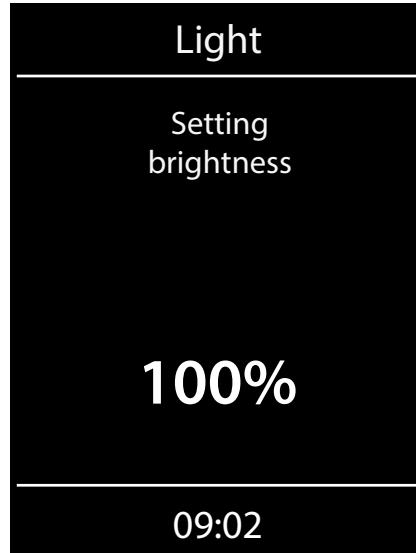

① The value can be set in 1% increments between 0% and 10% and in 5% increments between 10% and 100%.

4.5.6 One-time heating period

This function allows you to define a one-time heating period for a single day.

You can also set recurring heating periods if the system is used commercially.

- ▶ Setting a one-time heating period, [p 34](#)
- ▶ Deleting timer settings, [p 36](#)

► Setting a one-time heating period

- 1  : Select and confirm.

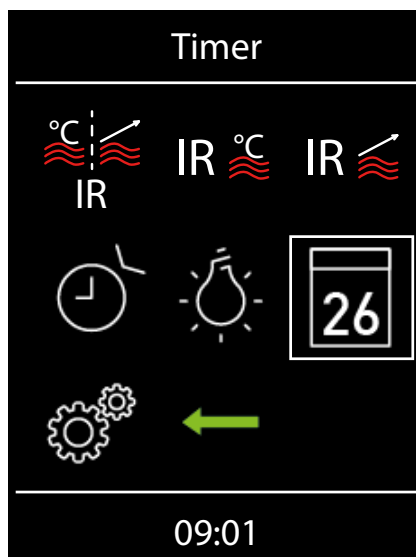

- 2  : Select and confirm.

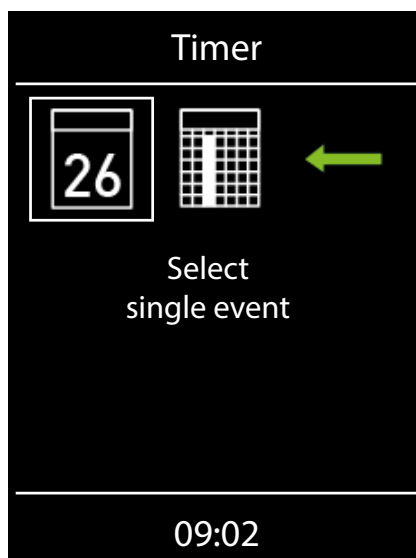

- 3 Set the year, month and day and confirm your settings.



- 4 Set the hours and minutes and confirm.

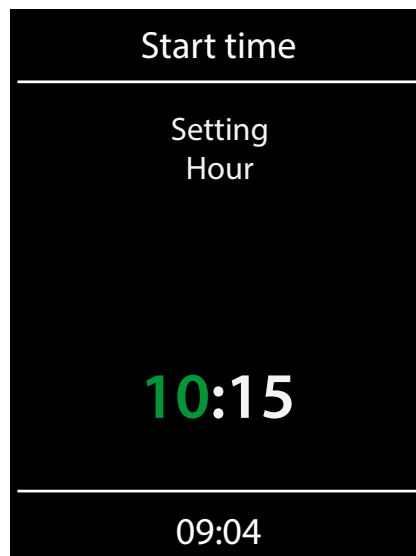

- ① The maximum heating period can be pre-set. See 5.3 Heating time limitation, [p 74](#).
- ① You can set a temperature for the set period.
 - ▶ Setting the IR temperature, [p 28](#)
- ① The settings from the main menu are applied for the intensity. See 4.5.3 IR intensity, [p 29](#)

In addition to the time, the date and the time of the next heating period flashes in the status bar.

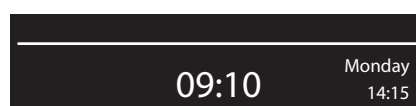

► Deleting timer settings

- 1 Press .
Alternately, you can set the time to --:--.
► Setting a one-time heating period, [p. 34](#)

4.5.7 Recurring heating periods

Recurring heating periods can be set only if the system is used commercially.

It is possible to set up to four separate heating periods each day of the week, whereby the maximum duration must not be exceeded. For example, you can set only one heating period for all days of the week and 2–3 additional heating periods on specific days of the week. These could be weekend days on which the sauna is often used.

You can set a different temperature for each heating period.

Please observe any applicable standards for intermissions between heating periods.

- Setting the time for the first heating period of the series, [p. 36](#)
- Setting the second heating period in the series, [p. 40](#)
- Deleting the heating period in a series, [p. 40](#)

► Setting the time for the first heating period of the series

- 1  : Select and confirm.

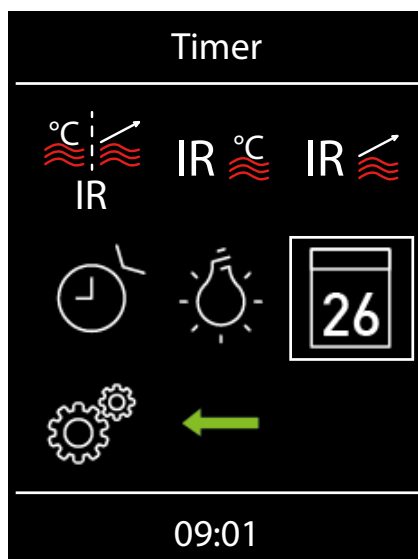

- 2  : Select and confirm.

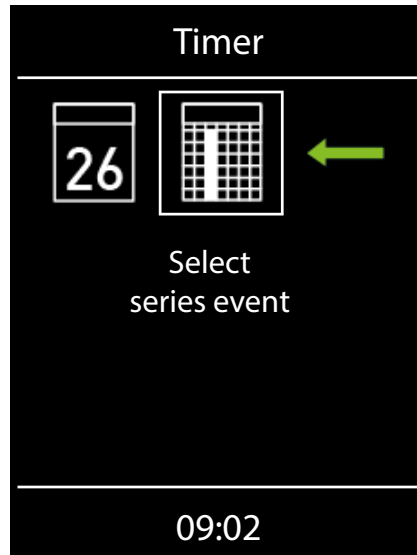

- 3 Select the day of the week and confirm.

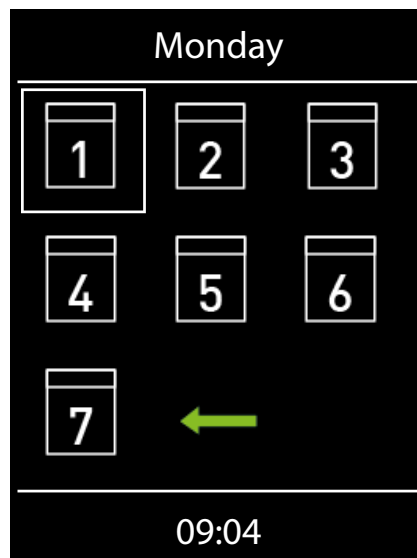

Operation

- 4 Select the number for the first heating period of the series and confirm.

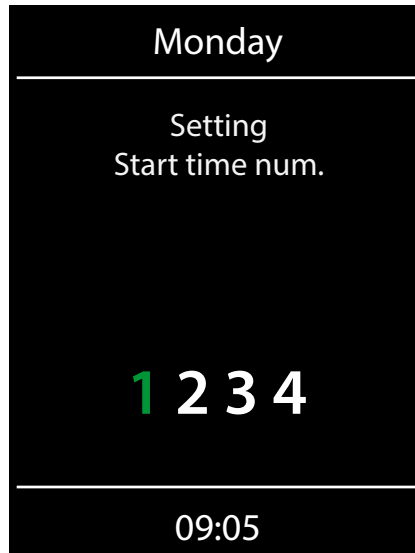

- ① Enter the start time and runtime for each heating period.

- 5 Set the hours and minutes for the start time and confirm.

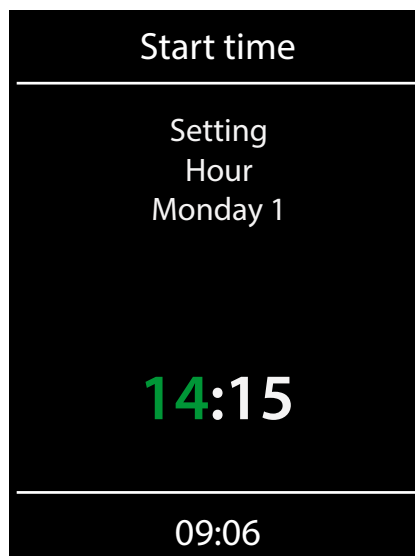

- 6 Set the hours and minutes for the duration of the heating period and confirm.

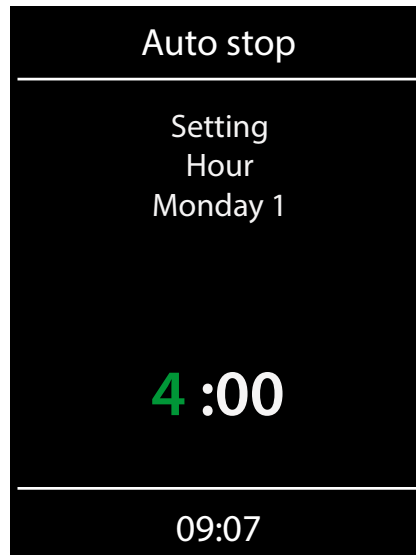

- ① If used commercially, the setting depends on the pre-set heating time limit. See 5.3 Heating time limitation, [p 74](#).
- ① The maximum heating period can be pre-set. See 5.3 Heating time limitation, [p 74](#).
- ① You can set a temperature for the set period.
 - ▶ Setting the IR temperature, [p 28](#)

► Setting the second heating period in the series

- 1 Repeat the steps for the next heating period:

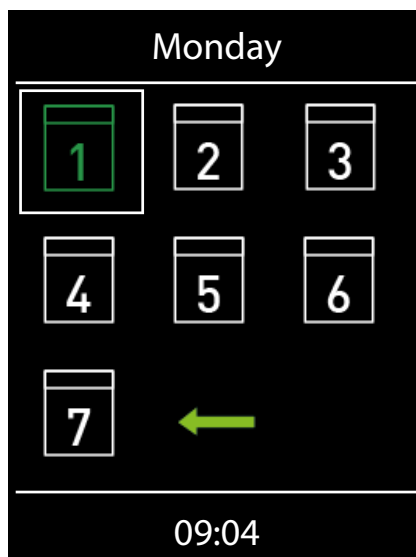



① Days of the week with a recurring heating period are displayed in green.

- a) Choose the recurring heating period.
 - b) Choose the day of the week.
 - c) Choose the next number. Green numbers already have a heating period defined.
 - d) Set the start time and runtime.
 - e) Confirm the operating mode.
 - f) Set the temperature.
- ① In addition to the time, the date and the time of the next heating period flashes in the status bar.



► Deleting the heating period in a series

- 1  : Select and confirm.
- 2  : Select and confirm.
- 3 Select the day of the week and confirm.
- 4 Select the number of the heating period and confirm.

- 5 Set the start time to --:-- and confirm the setting twice.
 - ① This deletes the specific heating period for the current series. All other defined heating periods remain set.
- 6 Repeat the step as needed for additional start times in the series.
 - ① When all heating periods on a given day of the week are deleted, the day appears in white again on the display.

4.5.8 Switching ECO mode on/off

ECO mode is activated during intermissions in operation to lower the temperature and prevent the cabin from cooling down completely. The heating must be switched on to activate ECO mode.

ECO mode can be activated as follows:

- From the main menu. ► Activating ECO mode in the main menu, [42](#)
- Using a push button that is available as an option.

ECO mode can be deactivated as follows:

- It is switched off automatically once the period of time set in the service menu expires. A runtime must be defined in the service settings for this. See 5.1.7 Setting the ECO runtime, [70](#)
- From the main menu. ► Cancelling ECO mode from the main menu, [42](#)
This option allows you to cancel ECO mode early even if a runtime has been pre-set.
- Using a push button that is available as an option.

► Activating ECO mode in the main menu

- 1  : Select and confirm.

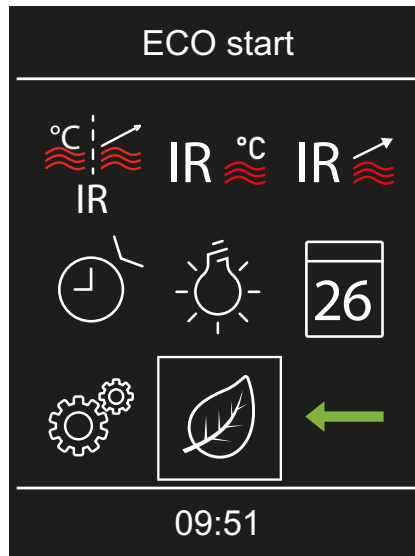

- ECO mode is activated. The ECO icon is displayed in the status bar.



► Cancelling ECO mode from the main menu

- 1  : Select and confirm.

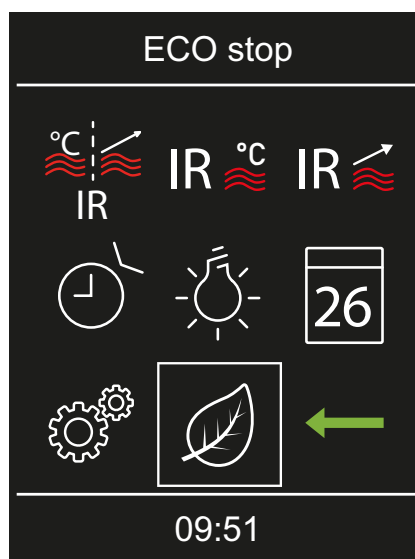

- ECO mode is deactivated. The heating is started up again as defined in the settings.





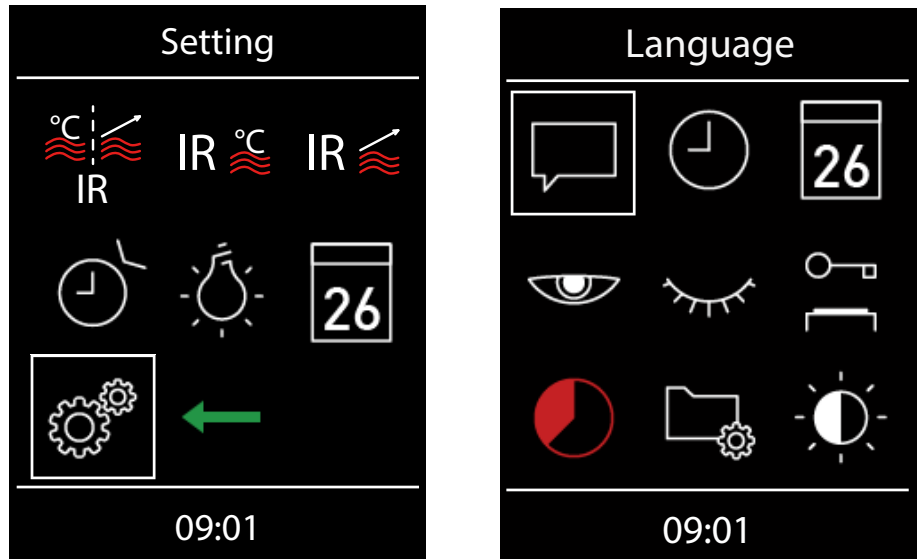





4.6 Advanced settings

Advanced settings can be found in the main menu.



Advanced setting icons



The icons displayed depend on the modules installed.

- | | |
|---|---|
|  Language selection,
► Defining the user interface language, 21 |  Time,
► Setting the time, 22 |
|  Date,
► Setting the date, 22 |  Screen saver,
► Setting the time for screen saver activation, 44 |
|  Standby,
► Setting the time for standby mode activation, 45 |  Operational lock/child lock, ► Entering the PIN for the operational lock/child lock and activating it, 47 |
|  Auto stop (heating period),
► Setting the heating period, 49 |  Operating data,
Chapter 4.6.5 Operating data, 51 |
|  Display brightness,
► Setting the contrast, 55 |  Holiday cottage mode,
► Entering the PIN for holiday cottage mode and activating it, 57 |

4.6.1 Screen saver

You can set a time after which the screen saver appears on the display. The screen saver is activated only when the system is switched off.

► Setting the time for screen saver activation

- 1  : Select and confirm.
- 2  : Select and confirm.

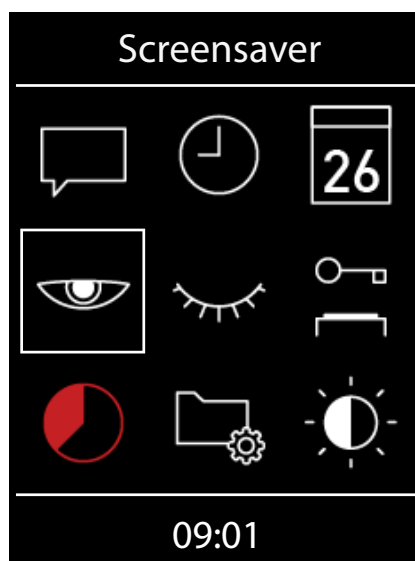

- 3 Set the hours and minutes and confirm.

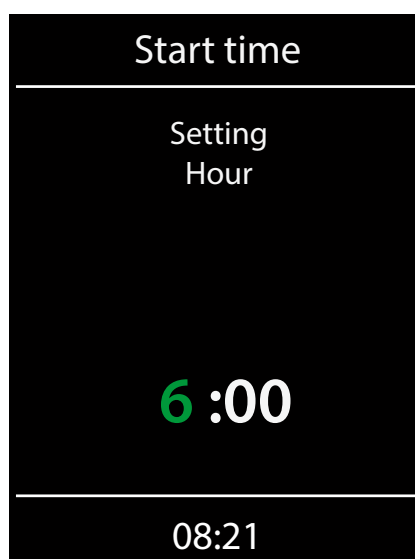



- The time is saved. The home screen with date and time is displayed as the screen saver.

4.6.2 Standby mode

This setting allows you to define the amount of time after which the control panel switches to sleep mode. Standby mode is activated only when the system is switched off.

In sleep mode, the display is completely black. Turn the jog dial to wake the control panel from sleep mode.

► Setting the time for standby mode activation

- 1  : Select and confirm.
- 2  : Select and confirm.

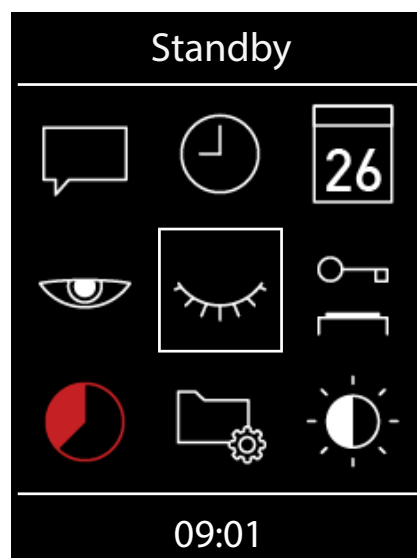

- 3 Set the hours and minutes and confirm.

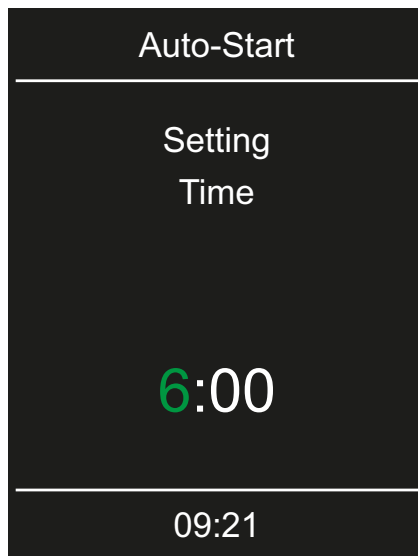

- The time is saved. The home screen with date and time is displayed in standby mode.

4.6.3 Operational lock/child lock

You can lock the system to prevent unauthorised access. To do so, you must enter a PIN to lock the system so it cannot be operated. You may choose the PIN. It must contain 4 digits. It is no longer possible to operate the system if you lose the PIN.

- ▶ Entering the PIN for the operational lock/child lock and activating it, [47](#)
- ▶ Deactivating the operational lock/child lock, [48](#)
- ▶ Resetting the PIN for the operational lock/child lock, [48](#)

NOTICE

No access to the control unit

The control unit cannot be used if the PIN is not known.

- ▶ Save the PIN in a safe place.
- ▶ Contact your retailer or EOS Service if you lose your PIN.

► **Entering the PIN for the operational lock/child lock and activating it**

1  : Select and confirm.

2  : Select and confirm.

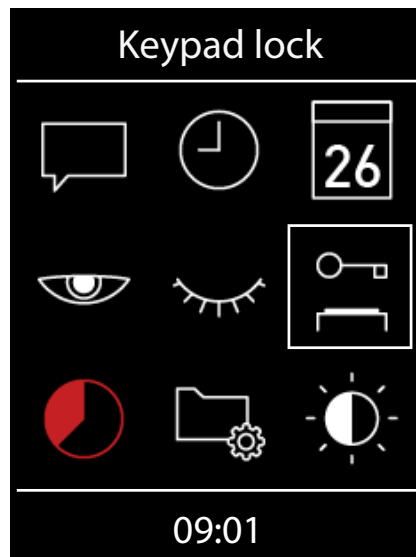

3 Enter the PIN and confirm.

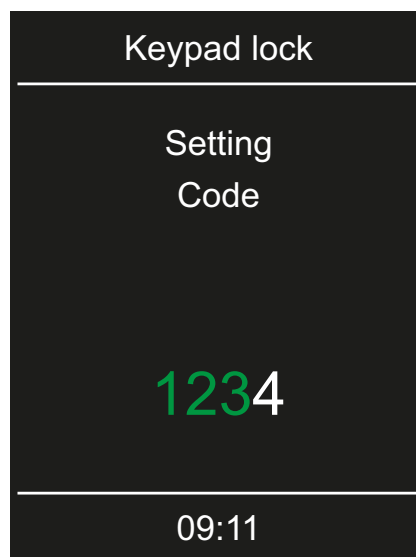



Enter the numbers and confirm each number. Confirmed numbers are displayed in green.

- ① The display switches to the standby screen and is locked.
- ① In this mode, it is only possible to switch off the heat if it is running and switch on the lighting. You must enter the PIN to use any of the other functions.

Operation

► Deactivating the operational lock/child lock

- 1  : Select and confirm.
- 2  : Select and confirm.
- 3 Enter the PIN and confirm.
 - The display switches to the standby screen. All functions are available again.

► Resetting the PIN for the operational lock/child lock

- 1 Turn the jog dial briefly.

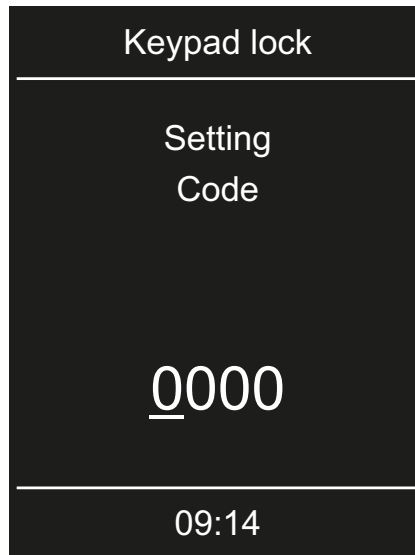

- 2 Confirm the first zero (0).

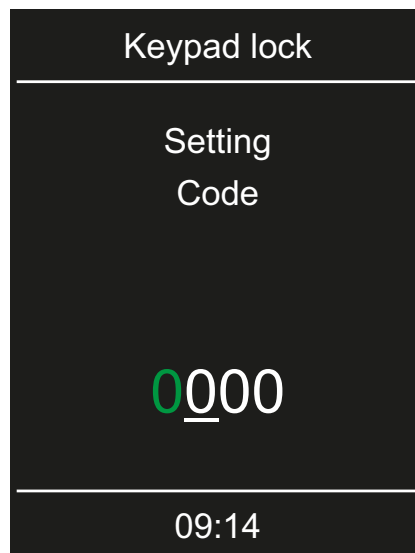

 The cursor appears under the second zero.

- 3 Press and hold down the jog dial for approximately 40 seconds until all four zeros appear white.
 - ① During this time, the cursor jumps to the third zero.
- 4 Confirm all four white zeros.
 - ① The zeros are displayed in green.
 - ☑ The display switches to the standby screen. The lock is removed and all functions are available again.



4.6.4 Heating period – auto stop

You can set a heating period for the IR emitters.

If the system is used in a private setting, the heating period is limited to 6 hours. If the system is used commercially, there is no limit for the heating period. Please observe the statutory intermission times.

5.3 Heating time limitation,  74

► Setting the heating period

- 1  : Select and confirm.
- 2  : Select and confirm.

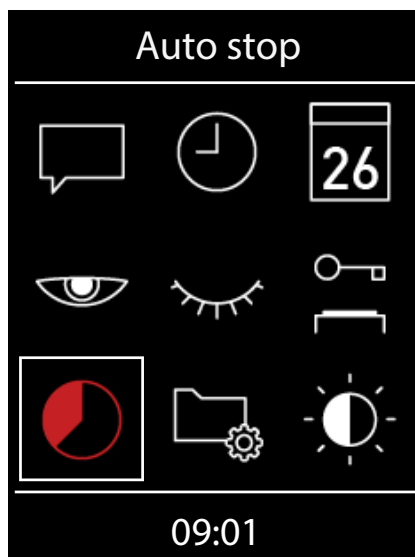

- 3 Enter the runtime in hours and minutes and confirm.

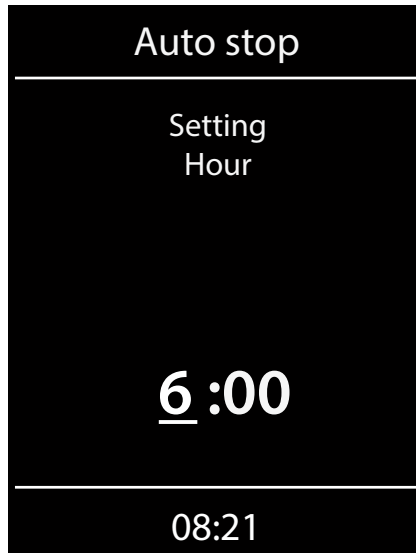

- ① A line appears under the active place value.
- ① If the system is used in a private setting, the heating period is limited to 6 hours. Therefore, it is only possible to decrease the heating period. If the system is used commercially, you must observe the statutory intermission times.
- ① The end of the heating period is displayed in the top bar.

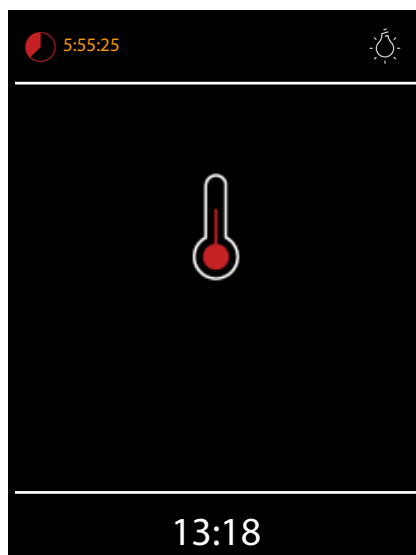

4.6.5 Operating data

You can retrieve data on the control panel's current firmware version, the modules and the service interval.

- ▶ Retrieving the firmware version and unit serial number, [p 51](#)
- ▶ Retrieving the next service date, [p 52](#)
- ▶ Retrieving contact data, [p 54](#)

▶ Retrieving the firmware version and unit serial number

1  : Select and confirm.

2  : Select and confirm.



3  : Select and confirm.





Operation

- 4 Use the jog dial to choose the display for the control panel or for the relay box.



► Retrieving the next service date

- 1  : Select and confirm.
- 2  : Select and confirm.





- 3  : Select and confirm.





The amount of time remaining until the next service date is displayed. The operation time is set to 500 hours by the factory.

Operation

► Retrieving contact data

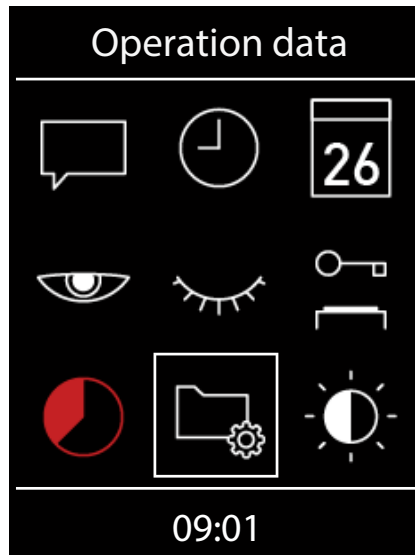
- 1  : Select and confirm.
- 2  : Select and confirm.



- 3  : Select and confirm.

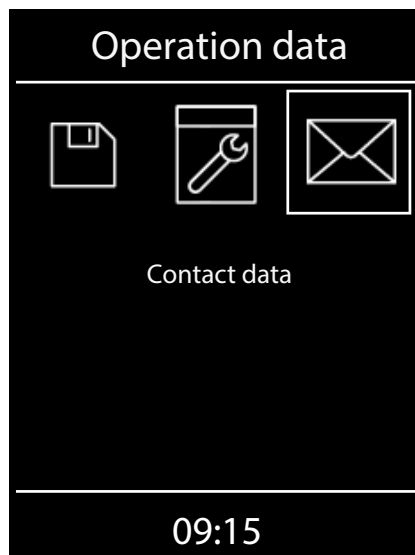



4.6.6 Display brightness

You can adjust the display's brightness to accommodate environmental conditions.

► Setting the contrast

1  : Select and confirm.

2  : Select and confirm.

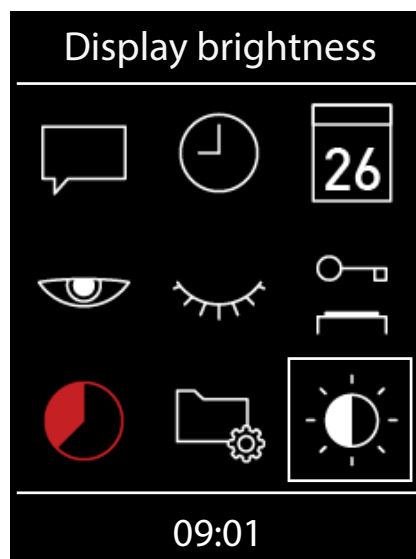

- 3 Select the desired brightness and confirm.

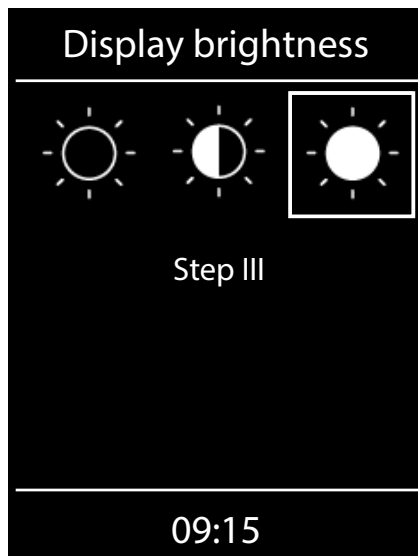

ⓘ The brightness is adjusted immediately.

4.6.7 Holiday cottage mode

You can lock the system to prevent unauthorised access. To do so, you must enter a PIN for holiday cottage mode to lock the system.

The following settings are available in holiday cottage mode:

- Switch the lighting on/off.
- Switch the IR emitters (heating) on/off.
- Select the IR operating mode.
- Set the IR temperature.
- Set the IR intensity.

You may choose the PIN. It must contain 4 digits. It is no longer possible to operate the system if you lose the PIN.

- ▶ Entering the PIN for holiday cottage mode and activating it, [p 57](#)
- ▶ Unlocking holiday cottage mode, [p 58](#)
- ▶ Resetting the PIN for holiday cottage mode, [p 58](#)

NOTICE

No access to the control unit

The control unit cannot be used if the PIN is not known.

- ▶ Save the PIN in a safe place.
- ▶ Contact your retailer or EOS Service if you lose your PIN.

If the holiday cottage mode is active, the language selection is displayed first after the system is switched on again by pressing the main switch. The pre-selection is EN.

► **Entering the PIN for holiday cottage mode and activating it**

1  : Select and confirm.

2  : Select and confirm.

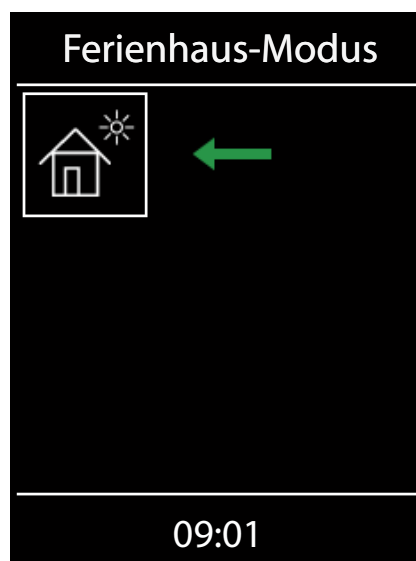

3 Enter the PIN and confirm.

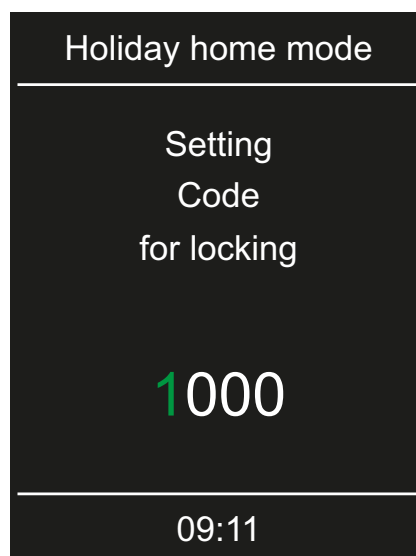



Enter the numbers and confirm each number. Confirmed numbers are displayed in green.



① The display switches to the standby screen and is locked.

Operation

► Unlocking holiday cottage mode

- 1  : Select and confirm.
- 2  : Select and confirm.
- 3 Enter the PIN and confirm.
 - The display switches to the standby screen. All functions are available again.

► Resetting the PIN for holiday cottage mode

- 1  : Select and confirm.
- 2  : Select and press and hold the jog dial for approx. 1 minute.

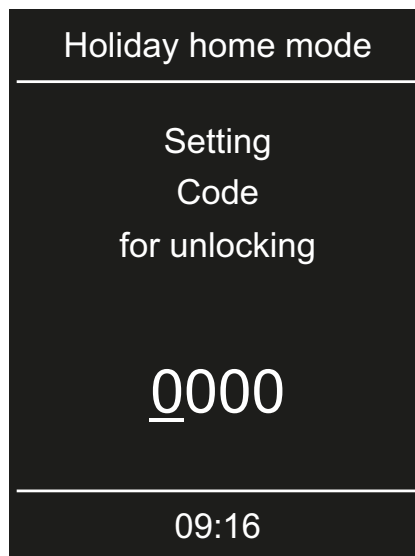

- 3 Confirm all four white zeros.
 - The zeros are displayed in green.
 - The display switches to the standby screen. The lock is removed and all functions are available again.

4.7 Troubleshooting

Error message and icons on the control panel indicate operating statuses and fault conditions.

Fault	Reason	Solution
Control panel display is blank	No power supply.	Switch on the relay box.
		Check the relay box's mains connection.
		Check fuses.
		Check the power supply
IR intensity cannot be set.	Channels are not set.	Define channel groups.
IR emitters do not heat.	Unit not detected.	Set unit address for the module.
	Channel groups not defined.	Define channel groups.
	Jumpers not set.	Set JP1 and JP2 for connections IR-1 and IR-2.
Thermo-fuse tripped.	Temperature too high.	Check cause of excess temperature. Replace fuse.
Unknown error.		Restart unit. Contact technical support.
No bus communication.	Too many add-on modules connected.	Connect IR module with separate power supply.
	Bus connection plug not plugged in.	Plug in plug.
	Bus cable damaged.	Replace bus cable.
	Unit not detected.	Set unit address for the module.

5

Service settings

This chapter is intended for service technicians.

A description of the user interface and the common icons are found in the chapter entitled Operation, [p 17](#).

⚠ CAUTION

Health risks

Incorrect settings can raise the cabin temperature to a level that is prohibited and extend the heating period to an impermissible amount of time.

This can lead to serious health risks or even death in persons with health impairments.

- ▶ Only trained personnel may change settings at the service level.
 - ▶ Service level code (5349) should be given only to trained personnel.
-





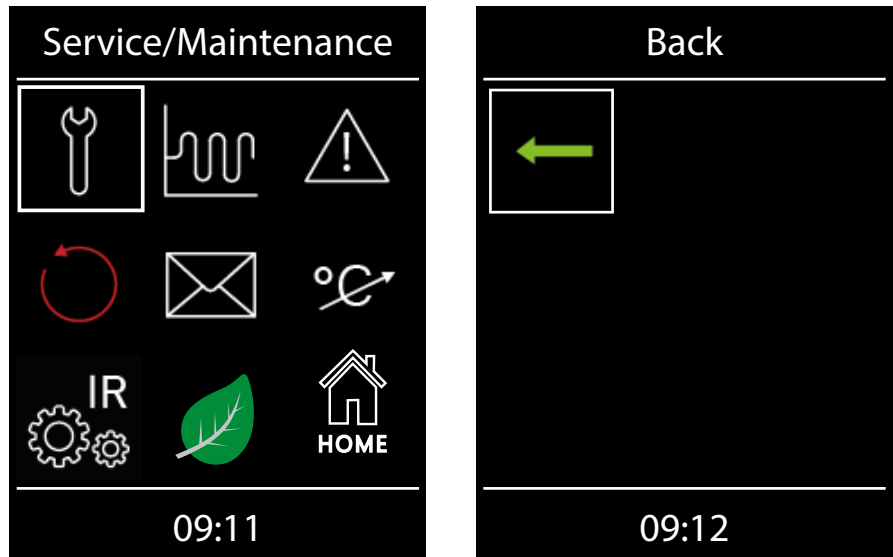





5.1 Service level

Access to the service level is protected by a code.
The settings at this level must only be changed by trained personnel.



☞ Service settings

Icons

- | | | | |
|---|--|---|--|
|  | Service/maintenance
▶ Defining the service interval, p 63 |  | Hysteresis
▶ Setting the hysteresis, p 64 |
|  | Use
▶ Defining the type of use, p 23 |  | Reset function
▶ Resetting the settings, p 65 |
|  | Display manufacturer contact data |  | Temperature control
▶ Setting the cabin temperature, p 66 |
|  | IR setup
▶ Configuring the IR channel groups, p 68 |  | ECO
▶ Setting the ECO function runtime, p 70 |
|  | HOME function
See separate documentation. |  | Back |

Service settings

5.1.1 Opening service settings

Service settings must only be changed by trained personnel.

► Opening the service settings menu

- 1  : Select and press and hold the jog dial until the code entry is displayed.

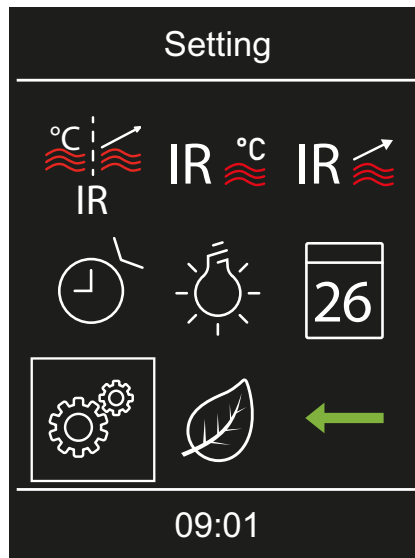

- 2 CAUTION! Only trained personnel may change settings at the service level.

Enter code **5349** and confirm.

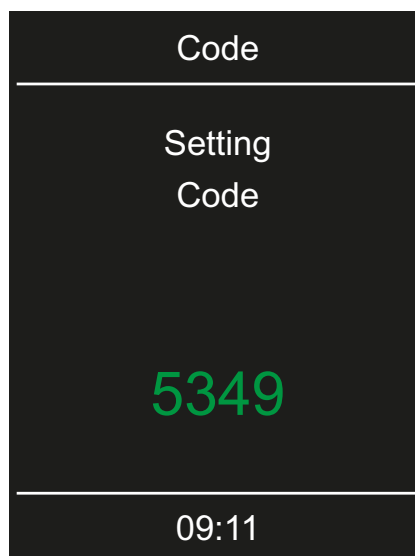

- ⓘ Increase or decrease the individual numbers and confirm. Confirmed numbers appear green.

- 3 Select the desired icon and confirm.

5.1.2 Service/maintenance

You can define the intervals for service/maintenance so that they are in line with operating conditions. The interval is set to 500 hours by the factory.

► Defining the service interval

- 1 Open the service settings.
① See 5.1.1 Opening service settings, [p 62](#)
- 2  : Select and confirm.
- 3 Increase or decrease the displayed interval.

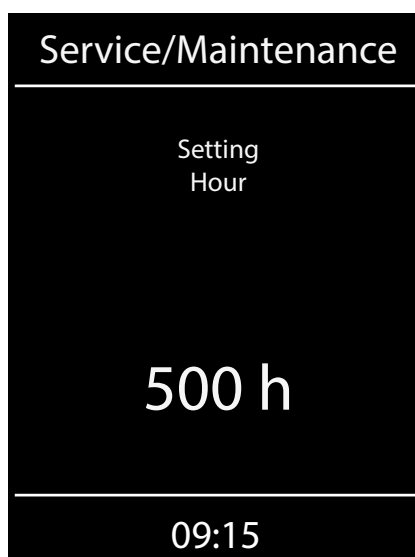

① The value can be increased or decreased by increments of 250.

- 4 Confirm the set value.
① When it is time for service again, a reminder with the saved contact data is displayed when the unit starts.
① For information about the amount of time remaining before service is required again, see ► Retrieving the next service date, [p 52](#).

5.1.3 Switching hysteresis for the IR temperature

In the service settings, you can also set a temperature range within which the IR emitters are switched on and off.

The hysteresis has no effect on dimmable IR emitters connected to connections IR-1 and IR-2.

Example — 46°C target temperature and hysteresis 4 K: The heater is switched off at 48°C and switched on at 44°C.

Service settings

► Setting the hysteresis

- 1 Open the service settings.
 ⓘ See 5.1.1 Opening service settings, [p 62](#)
- 2  : Select and confirm.

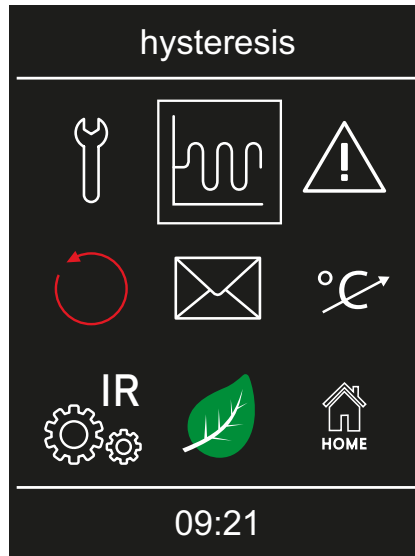

- 3 Set the value and confirm.

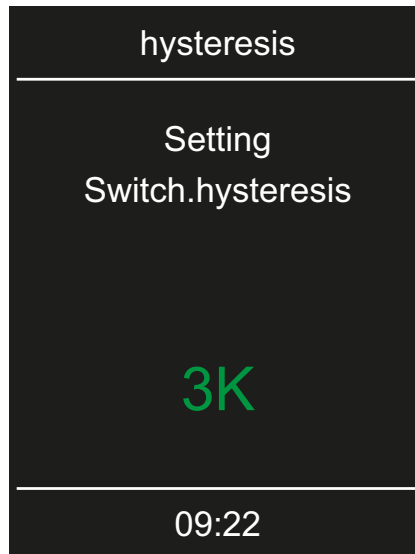

- ⓘ The setting range is between -10 K and +10 K. The value is set to 5 K by the factory.
- ☑ The value is saved and the display returns to the selection screen for advanced settings.

5.1.4 Reset function

You can perform a factory reset to restore the operating data or all of the settings.

► Resetting the settings

- 1 Open the service settings.
① See 5.1.1 Opening service settings, p 62
- 2  : Select and confirm.



- 3 Select the setting and confirm.

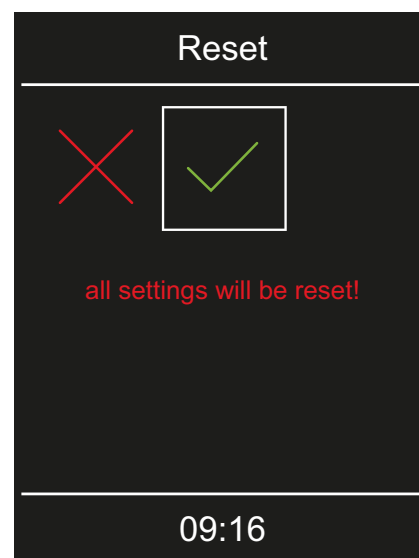
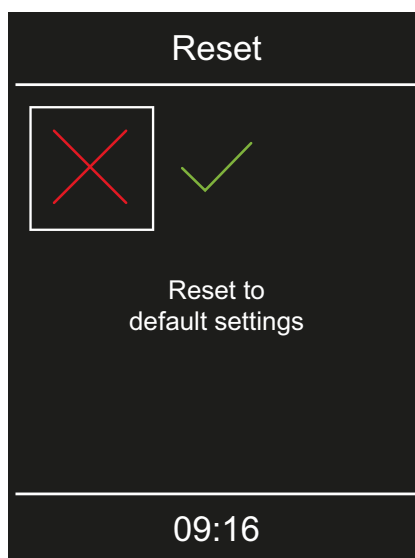

- ① Any customised settings that have been set will be lost.
- ☑ If you reset the settings, the control panel restarts and the cabin settings must be reset.

Service settings

5.1.5 Temperature control

This function allows you to adjust the displayed actual temperature in relation to the actual ambient temperature. This offset can be set to a higher or lower value between -10 K to +10 K.

Example — 2 K: The temperature is displayed approx. 2 K lower than it would be if a different measuring device were used.

This function should be set by experienced personnel only and must be sufficiently tested, since it is easy for cabin temperatures to become too high.

► Setting the cabin temperature

- 1 Open the service settings.
① See 5.1.1 Opening service settings, [p 62](#)
- 2  : Select and confirm.





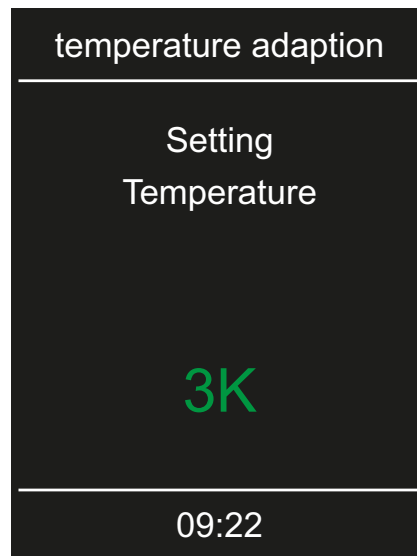













3 Set the desired offset and confirm.



5.1.6 Configuring the channel groups

The connected IR emitters must be assigned to channel groups. All IR emitters belonging to a channel group are controlled together. The following icons are used to assign the IR emitters.

	Front middle		Front right
	Front left		Back middle
	Back left		Back right
	Leg		Ceiling
	Floor		Side right
	Side left		IR group 1
	IR group 2		IR group 3
	IR group 4		IR group 5

Service settings

► Configuring the IR channel groups

- 1 Open the service settings menu.
► Opening the service settings menu, [p 62](#)
- 2  : Select and confirm.



- 3 Select the channel and confirm.

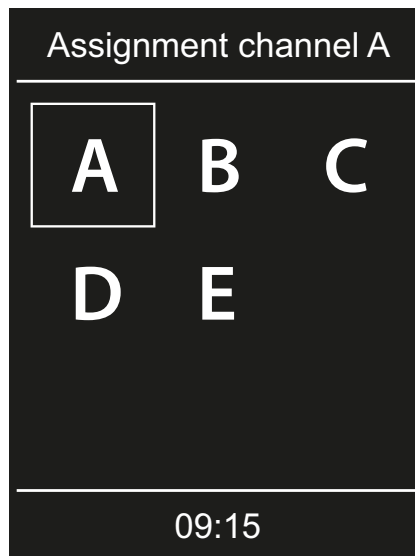

4 Select the channel assignment and confirm.

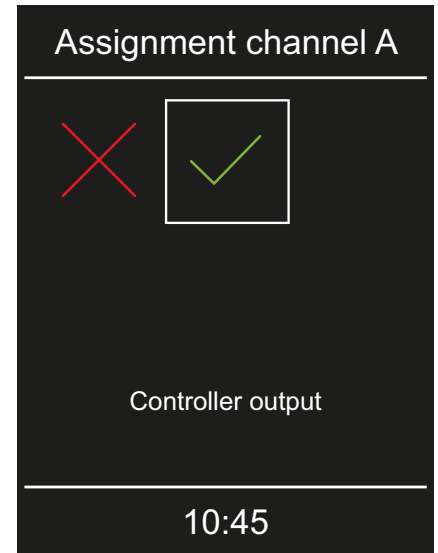
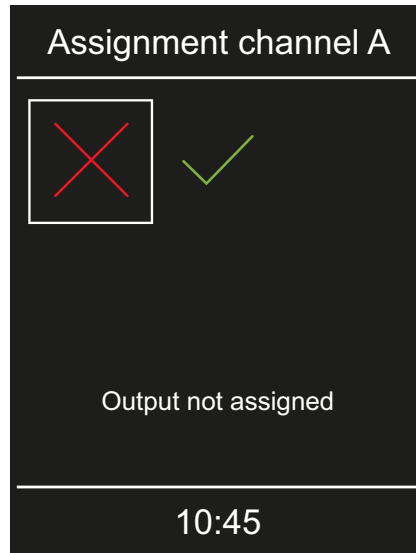

5 Select the IR emitter icon and confirm.

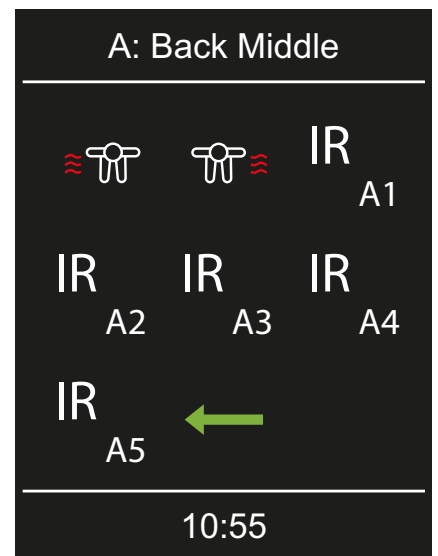
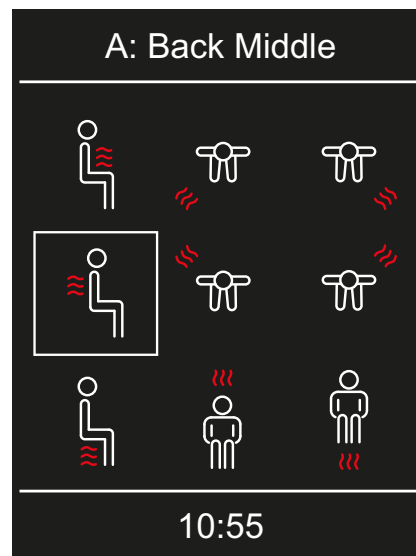

① You may assign each icon only once.

6 Follow the same steps to configure the next channel group.

- ① Once the channel groups are configured, the IR temperature and IR intensity can be set.
 - ▶ Setting the IR temperature, [p 28](#)
 - ▶ Setting the IR emitter intensity, [p 29](#)

Service settings

5.1.7 Setting the ECO runtime

This function allows you to define a window of time during which the cabin temperature is lowered.

In an IR-only cabin, the ambient temperature is lowered as follows:

- IR temperature operating mode: The temperature is lowered using the following formula: $T_{ECO} = T_{Target} - ((T_{Target} - 30)/2)$.

Example:

$$T_{ECO} = (65 - (65 - 30)/2)$$

$$T_{ECO} = 65 - 17.5$$

$$T_{ECO} = 47.5^{\circ}\text{C}.$$

- IR intensity operating mode: The intensity is reduced by half.
- IR emitters connected to IR-3 are shut off completely.

The window of time can be set to a value between 0 and 240 minutes in 30 minute-increments.

The setting is useful if there are intermissions in operation to prevent the cabin from cooling down completely.

The ECO function is switched on via the control panel or via a push button that is available as an option. It is automatically switched off after the defined duration or ended by pressing the push button.

See 4.5.8 Switching ECO mode on/off, [41](#)

► Setting the ECO function runtime

- 1 Open the service settings.
 ⓘ See 5.1.1 Opening service settings, [62](#)
- 2  : Select and confirm.



3 Set the value and confirm.





- ① A value between 0 and 240 minutes can be selected in 30 minute-increments. The ECO function starts if ECO mode is activated in the main menu or by pressing the push button that is available as an option.
See 4.5.8 Switching ECO mode on/off, 41
- ① If the setting is 0 minutes, you must manually switch the ECO function on or off by pressing the push button.

5.2 Defining the light source manually

The control panel is set to inductive loads by the factory so that resistive loads can also be controlled by the control panel. If required, the light output can also be manually set to capacitive loads.

If light bulbs are used, the load for lighting must remain as an inductive load.

The current setting is shown on the display.

Display symbol	Setting	Code
	Inductive/resistive load (lighting with phase control), if light bulbs are used. Factory setting	8001
	Capacitive load (lighting for phase control) Electrical ballasts for phase-cut dimmer	8002

NOTICE**Material damage**

Improper setup can damage the unit. In this case, the warranty becomes void.

- ▶ Work must only be performed by a trained technician from an authorised company specialised in the trade.

For this setting, the lighting must be disconnected.

▶ **Setting the load for lighting to resistive load**

- 1 Disconnect the relay box from the power supply.
- 2 Open the relay box's housing.
 - ① Refer to the installation instructions.
- 3 **DANGER!** Ensure that the relay box is disconnected from the power supply. Disconnect the light source from the main circuit board.
- 4 Reconnect the power supply and switch on the relay box again.
- 5  : Select and press and hold the jog dial until the code entry is displayed.

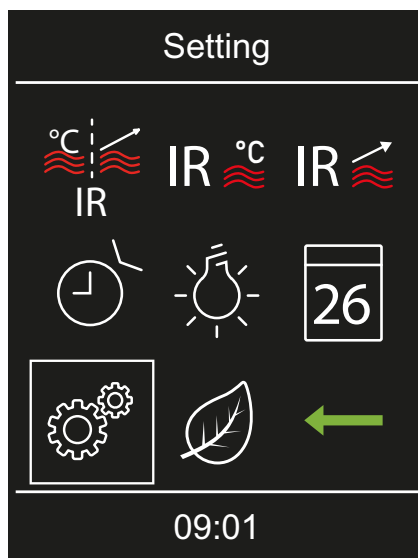

- 6 Enter the code and confirm.

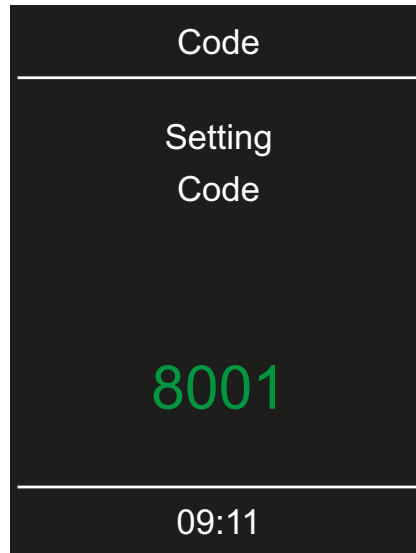

- ① Code **8001**: Inductive/resistive load.
- ① Code **8002**: Capacitive load.

- 7 Disconnect the relay box from the mains supply and reconnect the light source.
- 8 Close the housing again.
- 9 Reconnect the power supply and switch on the relay box again.
- 10 Dim the cabin lighting.

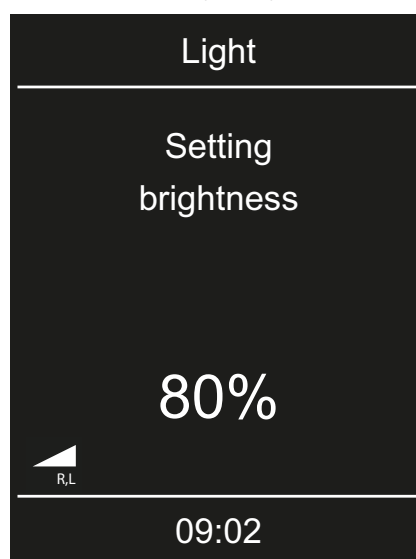

- 11 Check the setting on the display.

5.3 Heating time limitation

For private use, the heating time is limited to 6 h.

For commercial use, the heating time can be set to 6 h, 12 h or infinite.

Heating period	Code
6 hours	8206
12 hours	8212
Unlimited 24 hours/7 days a week	8224

The number of hours applies to a continuous heating time. The heating automatically switches off once the heating time has ended.

► Setting the heating time limitation

- 1  : Select and press and hold the jog dial until the code entry is displayed.

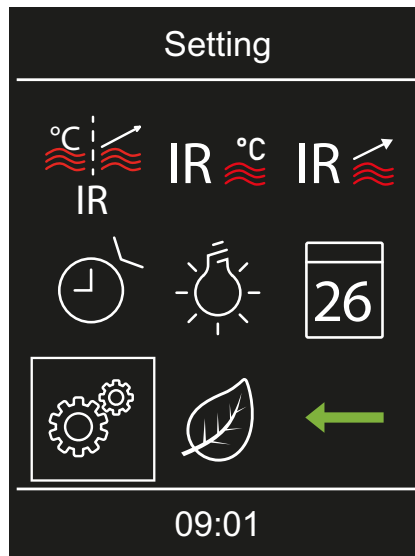

2 Enter the code and confirm.

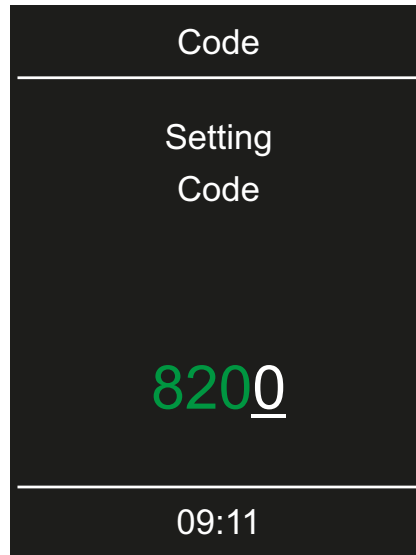

- ① Code **8206**: 6 hours.
- Code **8212**: 12 hours.
- Code **8224**: 24 hours/7 days a week.

5.4 Updating firmware

To update the software used by the Emotec IR control panel, you need a microSD or microSDHC card with a minimum of 128 MB and maximum of 32 GB. The SD card must be formatted with the FAT32 file system.

You can obtain the update from EOS as follows:

- Card with firmware.
- ZIP file with the zipped update files as a download from the EOS home page.

NOTICE

Equipment damage due to a faulty update

The device can become unusable if the update is interrupted.

- ▶ Ensure that the power supply is not interrupted during the update process.
- ▶ The update must be performed by trained personnel only.

Ensure that you have a backup of the old software version on your PC or an external drive. You will need this old version in the event that the update is not successful.

Service settings

You must remove the front panel before updating the software. Use a removal tool or a flathead screwdriver to remove the front panel.

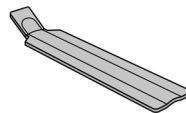

NOTICE

Damage to the unit due to improper dismantling

The display can become scratched. The circuit board can break.

- ▶ Do not tilt the front panel when dismantling.
- ▶ Apply a consistent amount of pressure to the removal tool or screwdriver when using it.
- ▶ Do not scratch the front panel with the tools.

-
- ▶ Preparing the memory card on a PC or laptop, [76](#)
 - ▶ Preparing the update, [76](#)
 - ▶ Dismantling the front panel, [77](#)
 - ▶ Installing the update, [77](#)
 - ▶ Repeating the update if unsuccessful, [78](#)

▶ Preparing the memory card on a PC or laptop

- 1 Insert the unformatted card in the card reader.
- 2 In Windows Explorer, select the card reader drive.
- 3 Open the context menu (right mouse click) and choose Format.
 - ⓘ The SD card must be formatted with the FAT32 file system.

▶ Preparing the update

- 1 Download the most recent firmware from the EOS website.
 - ⓘ eos-sauna.com/service-support/software
- 2 Unzipping the ZIP file:
 - a) Unzip the ZIP file you just downloaded and copy it to the formatted memory card.
 - b) Unzip the ZIP file on the supplied card.

► Dismantling the front panel

- 1 Switch the off switch on the relay box to 0.
- 2 Insert the removal tool in the slot at the base of the control panel between the front panel and the housing.

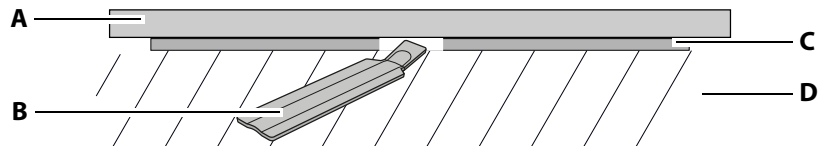

- | | |
|------------------------|-----------------------|
| A Front panel | C Bottom piece |
| B Removal tools | D Wall |

- 3 **NOTICE** Do not tilt the front panel to avoid damage to the display. Press the removal tool against the wall until the front panel comes loose from the bottom piece.
- 4 Remove the front panel with a consistent amount of force from the housing.
- 5 Rotate the front panel to the side until the circuit board is easy to access.

► Installing the update

- 1 **NOTICE** Ensure that the power supply is not interrupted during the update process.
Insert the memory card in the card slot on the control panel's circuit board.

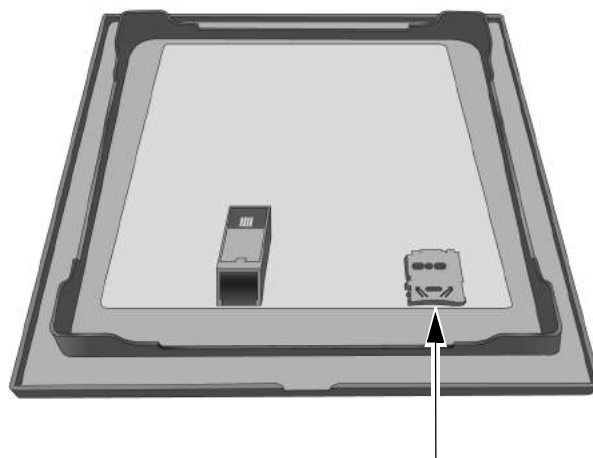

- ① Insert it until the card is clearly engaged.

Service settings

- 2 Switch the off switch on the relay box to I.
 - ① The progress of the update is displayed on the panel. The control unit restarts automatically once the update is complete.
 - ① The update was not successful if there is no icon after the relay box switches back on or if the software crashes during operation.
See ► Repeating the update if unsuccessful, 78
- 3 Remove the memory card after the update.
- 4 Place the front panel directly in front of the housing.
 - ① Ensure that it is aligned properly. The S-Bus connection must face downward.

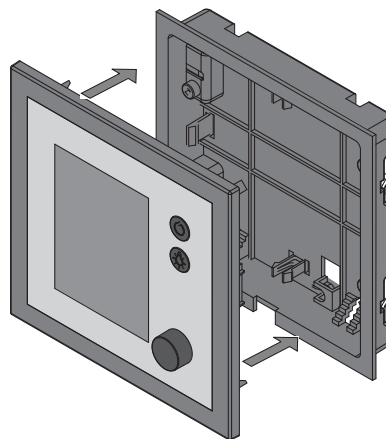

- ① Position the connecting cable in the bottom piece so that it is not pinched.
- 5 Press the front panel carefully with a consistent amount of pressure into the housing until it audibly snaps into place.
- **Repeating the update if unsuccessful**
- 1 Load the old software version onto the card.
 - 2 Perform the steps as described in ► Installing the update, 77.
 - 3 Repeat the update once the old software version has been restored.

6

General terms and conditions of service

(T&C, Dated 008-2018)

I. Scope

Unless otherwise agreed in writing for specific instances, these terms and conditions of service shall apply to service operations, including reviewing and remedying complaints. All our existing or future legal relationships shall be governed solely by the following terms and conditions of service. We do not recognise any of the customer's conflicting terms and conditions unless we have given our express written consent to their applicability.

We hereby expressly object to any of the customer's terms and conditions included in the customer's General Terms and Conditions of Business or order confirmation. Unconditional acceptance of order acknowledgments or deliveries shall not be construed as any form of acknowledgment of such terms and conditions. Ancillary agreements or amendments must be confirmed in writing.

II. Costs

The customer shall bear the following costs in connection with services rendered:

- Mounting/dismantling and electrical (de-)installation
- Transportation, postage and packaging
- Function testing and troubleshooting, including inspection and repair costs

There shall be no third-party billing.

III. Performance and cooperation obligations

The customer shall provide assistance free of charge to the manufacturer in rendering services.

In the case of a warranty claim, the manufacturer shall provide replacement parts necessary for servicing free of charge.

General terms and conditions of service

IV. Service visit by the manufacturer

Services rendered on site by an employee of the manufacturer must be agreed in advance.

If the main reason for the service visit is not the fault of the manufacturer, any costs incurred shall be charged to the customer after the service visit and must be paid by the customer in full within the agreed payment term.

V. Liability

The manufacturer shall assume liability in accordance with the currently applicable statutory regulations. All our products are packaged in such a way that the individually packed goods (pallets) can be shipped.

We wish to point out that our packaging is not suitable for individual shipments via parcel post. The manufacturer shall accept no liability for damages incurred as a result of improper packaging in an individual shipment.

VI. Manufacturer's warranty

The manufacturer's warranty shall apply only if installation, operation and maintenance have been carried out in full accordance with the manufacturer's specifications in the installation and operating instructions.

- The warranty period shall commence from the date on which proof of purchase is provided and shall be limited, in all cases, to 24 months.
- Warranty services shall be performed only if proof of purchase of the equipment can be presented.
- Any and all warranty claims shall become void if modifications are made to the equipment without the manufacturer's express consent.
- Any warranty claim shall likewise become void in the case of defects that arise due to repairs or interventions made by unauthorised persons or due to improper use.
- In the case of warranty claims, the serial and article numbers must be provided, together with the unit designation and a meaningful description of the fault.
- This warranty shall cover defective equipment parts, with the exception of normal wear parts. Wear parts shall include, for example, light

sources, glass elements, tubular heating elements and sauna heater stones.

- Only original replacement parts may be used within the warranty period.
- Service visits made by third parties shall require a written order issued by our service department.
- The equipment in question shall be sent to our service department by the customer at the customer's own expense.
- Electrical assembly and installation work, including service visits and parts replacements, shall be carried out at the customer's expense; costs shall not be borne by the manufacturer.

Complaints in respect of our products shall be reported to the responsible distributor and shall be handled exclusively by said distributor.

The manufacturer's General Terms and Conditions of Business, in the version available at www.eos-sauna.com/agb, shall apply in addition to the foregoing terms and conditions of service.

Disposal

7

Disposal



Electrical devices that are no longer needed must be recycled at a recycling station as per EU guideline 2012/19/EU or as per the Electrical and Electronic Equipment Act (ElektroG). Observe local provisions, laws, regulations, standards and directives when disposing of the unit.



Do not dispose of the unit with household waste.



Packaging

Emotec IR packaging can be completely separated for disposal and recycled. The following materials are used in the packaging:

- Used paper, cardboard
- Plastic
- Foam material

Electronic waste

Electronic waste must be disposed of at the designated local collection point for electronic waste.

Service address

EOS Saunatechnik GmbH

Schneiderstriesch 1

35759 Driedorf, Germany

Tel. +49 2775 82-0

Fax +49 2775 82-431

Web www.eos-sauna.com

Store this address with the Operating Instructions in a safe place.
Please always provide us with nameplate data, such as model, item number and serial number so we can provide fast and efficient support.

Date of sale

Stamp/retailer signature: