

EOS U-Command Steam

Steam room control unit

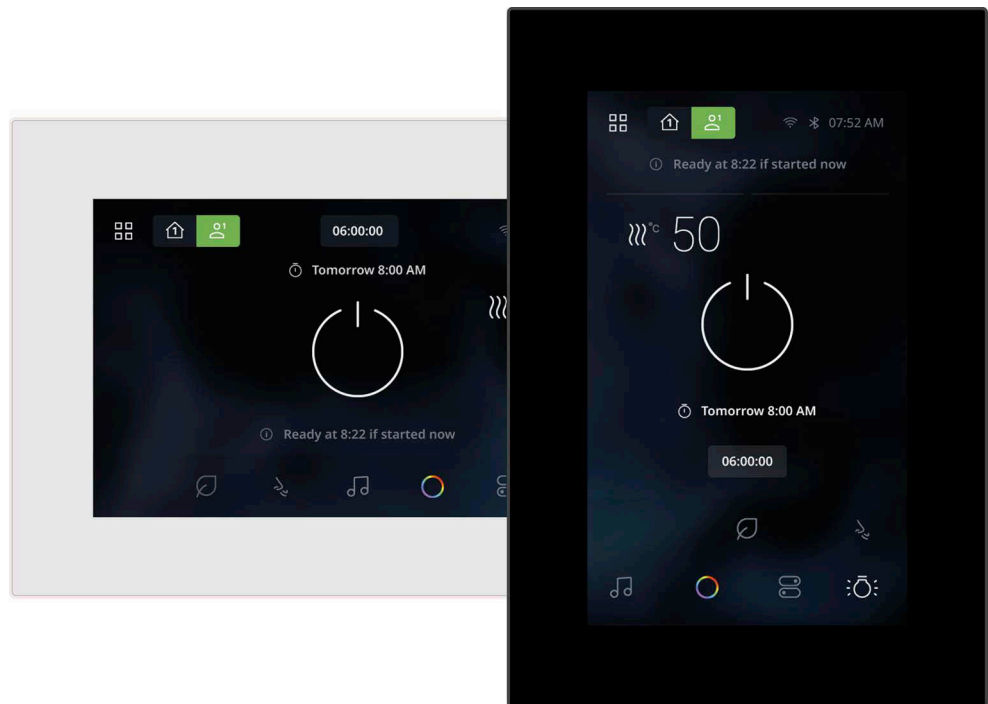

Installation Instructions

Made in Germany



Druck-Nr.: 2902 5547
Stand: 23/2026

Documentation

Manufacturer

EOS Saunatechnik GmbH	
Schneiderstriesch 1	
35759 Driedorf, Germany	
Tel.	+49 2775 82-514
Fax	+49 2775 82-431
Email	service@eos-sauna.com
Web	www.eos-sauna.com

Original installation instructions EN







Copyright for these installation instructions remains with EOS Saunatechnik GmbH.

Technical modifications are subject to change without notice. We accept no liability for errors or misprints.

Copyright as per DIN ISO 16016: The copying and distribution of this document, as well as the use and communication of its contents without express authorisation, are not permitted. Compensation will be claimed in the event of infringements.

All rights reserved with regard to patent claims or submission of design or utility patent.

Characters, symbols and illustrations

-  Additional information about an operating step
-  Cross-reference to a page
-  Read instructions
-  Result of a step
-  Table title
-  Title of figure
- \leq \geq Less than or equal to, greater than or equal to

Revision history

Date	Version	Description
1 June 2026	01.00	First version

Contents

Documentation	EN-2
1 General safety instructions	EN-5
1.1 Mounting and electrical installation	EN-5
1.2 Operator instruction	EN-6
1.3 Safety levels.....	EN-8
1.4 Standards and regulations	EN-8
2 Identification	EN-9
2.1 Nameplate	EN-9
2.2 Scope of delivery.....	EN-10
2.3 Technical data	EN-11
2.4 Accessories (optional)	EN-13
2.5 Intended use.....	EN-14
3 Installation	EN-15
3.1 Power supply and data lines	EN-15
3.2 Installation work inside the cabin	EN-16
3.2.1 Installing the temperature sensor	EN-17
3.2.2 Installing cabin lighting.....	EN-18
3.2.3 Fan.....	EN-19
3.3 Relay box.....	EN-20
3.3.1 Requirements.....	EN-20
3.3.2 Installing the relay box	EN-22
3.4 Control panel	EN-25
3.4.1 Installation example	EN-26
3.4.2 Line routing.....	EN-27
3.4.3 Mounting in the wall	EN-28
3.4.4 Mounting on the wall.....	EN-30
3.4.5 Completing control panel mounting	EN-31
3.5 Control panel removal	EN-34
4 Electrical installation	EN-35
4.1 Circuit board assignment.....	EN-36
4.2 Connections	EN-37
4.2.1 Control panel.....	EN-37
4.2.2 Additional relay box.....	EN-38
4.2.3 Add-on modules	EN-38
4.2.4 Temperature sensor.....	EN-39
4.2.5 STB terminal.....	EN-39
4.2.6 Door contact switch (optional).....	EN-40
4.2.7 Coloured light module and sound module (optional)	EN-40
4.2.8 Steam generator	EN-41

4.2.9	Dosing pump.....	EN-41
4.2.10	Fan.....	EN-41
4.2.11	Light.....	EN-42
4.2.12	Potential-free contacts.....	EN-43
4.3	Configuration (phase 1) of the hardware	EN-45
4.4	Completing electrical installation	EN-47
5	Commissioning	EN-48
5.1	Configuration (phase 2) of the software.....	EN-49
5.2	Light output	EN-49
5.3	Door contact switch (optional)	EN-50
5.4	Pairing with EOS Cloud	EN-51
5.5	Troubleshooting	EN-53
6	Operation	EN-54
6.1	User interface.....	EN-54
6.1.1	Elements.....	EN-54
6.1.2	Main screen	EN-55
6.1.3	Home screen for multi-cabin installation.....	EN-56
6.1.4	Multi-function bar.....	EN-57
6.2	Switch on cabin.....	EN-58
6.3	Switch off cabin	EN-59
6.4	Temperature	EN-60
6.5	Cabin lighting	EN-62
6.6	Switching on potential-free contacts	EN-63
6.7	Profiles.....	EN-64
6.8	User menu.....	EN-65
6.8.1	Heating time	EN-65
6.8.2	Pre-set timer	EN-66
6.8.3	Profiles	EN-68
6.8.4	Potential-free contacts icon	EN-69
6.8.5	Operating data	EN-69
6.8.6	Language	EN-70
6.8.7	Keypad lock	EN-70
6.8.8	Bluetooth	EN-72
6.8.9	WLAN and cloud	EN-72
6.8.10	Time and date	EN-72
6.8.11	Display	EN-73
6.9	Coloured light (optional).....	EN-74
6.10	Music player (optional).....	EN-74
6.11	Essence dosing (optional).....	EN-75
6.12	Updating firmware	EN-75
7	General terms and conditions of service	EN-76
8	Disposal	EN-79

1

General safety instructions**1.1 Mounting and electrical installation**

These installation instructions are intended for qualified personnel familiar with the laws and regulations applicable to electrical installations at the installation site. Observe the following general safety instructions during mounting, configuration and commissioning of the product.

Risk to life and limb and risk of fire

Risk to life and limb from electric shock and fire in the event of improper or faulty electrical connection. This risk remains also after completion of the installation work.

- ▶ The electrical installation of the relay box and other electrical systems or equipment with a fixed power supply connection must only be performed by a trained electrician from an authorised electrical company.
- ▶ Ensure compliance with the applicable regional standards and regulations for electrical installation.
- ▶ The system must be completely disconnected from the power supply before commencing installation and repair work.
- ▶ The housing cover must only be removed by a trained specialist.

Fire hazard from overheating

Insufficient ventilation can lead to device overheating and fire. Flammable parts must not exceed a temperature of 140°C when the unit is operated as intended or in the event of a malfunction.

- ▶ Do not install control panels, relay boxes and modules in enclosed cabinets or wood panelling.
- ▶ Observe the steam generator manufacturer's safety and installation instructions.
- ▶ Observe the cabin manufacturer's safety and installation instructions.

Damage to the unit

Corrosive or heavy saline atmospheres damage the contacts in the control panel, in the relay box and in the sensors.

- ▶ The control panel and sensors should not be installed in a corrosive or heavy saline atmosphere.

General safety instructions

1.2 Operator instruction

The operator of the steam room must be instructed in the general safety instructions during commissioning. The operator must be given a copy of the operating instructions.

The operator must make the end user aware of safety instructions that are relevant to the end user.

Risk of electric shock A risk to life and limb from electric shock and fire arises in the event of improper repair work. This risk remains also after work is completed.

- ▶ The housing covers must only be removed by a specialist.
- ▶ Repairs and installations must only be performed by a trained specialist.
- ▶ The system must be disconnected and removed entirely from the power supply before commencing repair work.
- ▶ Use only original spare parts from the manufacturer.

Risk of burns and scalding Touching hot parts may lead to skin burns and scalding.

- ▶ The operator must be familiar with the unit's hot parts and be able to identify them.
- ▶ The operator must be familiar with the settings for the heating period and understand how it is controlled.

Health risks Spending time in a steam room can lead to serious health risks or even death for persons with health impairments.

- ▶ Persons with health impairments who spend time in a steam room must consult a doctor before entering a steam room.

Damage to health Excessive time spent in the heated steam room can lead to overheating of the body (hyperthermia), which may cause serious health problems and even death. Hyperthermia occurs when the core temperature of the body exceeds the norm by a few degrees. Symptoms of hyperthermia include fever, dizziness, lethargy, sleepiness, and fainting. Side effects of hyperthermia include perception disorders, inability to recognize the need to leave the room, inability to identify imminent danger, harm to the foetus in the case of pregnant women, inability to physically leave the room and unconsciousness.

Alcohol, drugs, and medications increase the risk of hyperthermia.

- ▶ Do not exceed the maximum recommended time in the steam room.
- ▶ Leave the steam room if your body responds abnormally to the heat or if you do not feel well.
- ▶ Avoid alcohol, drugs, and medications when you are using the sauna.

Equipment damage due to overuse The uninterrupted operation time of the steam room can lead to property damage.

- ▶ If the steam room is used commercially, the heating period must be set so that the steam room switches off automatically after a specific period of time.
- ▶ If the heating does not switch off automatically after a defined heating period, steam room use must be supervised at all times.
- ▶ Inspect the steam room before each use.

Operation by children or persons with reduced mental capacity ▶ Children and persons with reduced physical, mental or sensory abilities must be supervised to ensure that they do not play with the unit.

- ▶ Children under 8 years of age should not operate the steam room.
- ▶ The settings for the heating period may only be changed by children 8 years of age or older if they are supervised by an adult.
- ▶ The steam room must only be used by persons with reduced mental capacity, or limited physical or sensory abilities under supervision or if they have been previously instructed in its use and understand the risks.
- ▶ Children and persons who have not received proper instruction must not clean or service the system.

General safety instructions

1.3 Safety levels

Safety instructions and important operating instructions are classified according to ANSI Z535.6. Please familiarise yourself with the following terms and symbols:

WARNING

Warning

Indicates a hazardous situation which, if not avoided, could result in death or serious injury.

CAUTION

Caution

Indicates a hazardous situation which, if not avoided, could result in minor or moderate injury.

NOTICE

Notice

Indicates a hazardous situation which, if not avoided, will result in damage to the unit.

1.4 Standards and regulations

For an overview of the standards that were observed during design and construction of the sauna heater, please refer to the individual product's technical data sheet that can be downloaded from www.eos-sauna.com. Local regulations also apply to the installation and operation of heating, sauna, and steam room systems.

2

Identification

EOS U-Command Steam is a steam room control unit used to control a steam room.

2.1 Nameplate

Nameplates are affixed to the relay box and control panel.

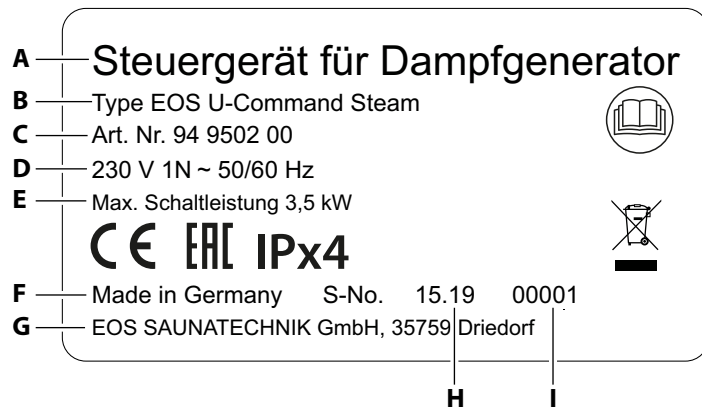

- | | |
|--|-----------------------------|
| A Name | F Country of origin |
| B Model | G Manufacturer |
| C Item number | H Manufacturing date |
| D Operating voltage | I Serial number |
| E Maximum switching output (kW) | |

Identification

2.2 Scope of delivery

Check the delivery to ensure that all components were delivered and that they are in proper working order. Contact your distributor if components are missing or damaged. The steam room control unit must not be operated if components are missing or damaged.

The following parts are included in the scope of delivery:

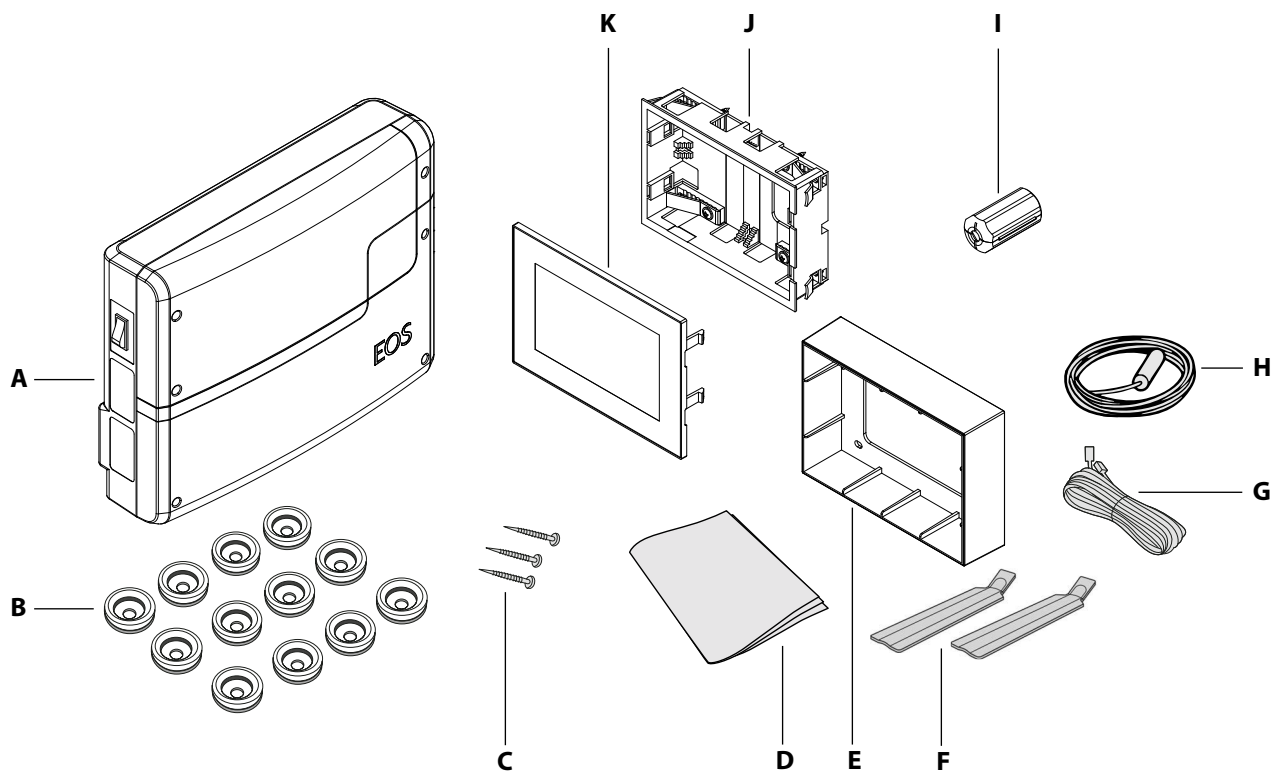

- | | |
|---|---|
| A Relay box | G 5 m Ethernet cable |
| B 12 bushings | H Temperature sensor incl. 5 m connecting hose |
| C 3 wood screws 4 x 25 mm | I Split ferrite |
| D Installation instructions | J Housing for mounting in the wall |
| E Housing for mounting on the wall | K Control panel |
| F Removal tools for control panel | |

2.3 Technical data

Power supply	230V 1N ~ 50/60 Hz
Switching output	Control signal only
Fuse	1 x 16 A
Ambient temperature	Control panel: -10°C to +60°C Relay box: -10°C to +45°C
Supply for terminal area/steam generator connection	0.5–2.5 mm ² rigid or flexible with wire-end ferrule, two conductors with identical cross-section per terminal can be connected.
Terminal area WM, 3, 4, light, fan	0.34–2.5 mm ² rigid or flexible with wire-end ferrule. Observe minimum cross-sections for fuse protection for the supply line.
Potential-free contact	Load rating of contact for resistive loads: - Maximum power supply: 10 A - Maximum voltage: 30 V DC/250 V AC
Storage temperature	-20°C to +60°C
Relay box housing	plastic
Dimensions (H x W x D)	Relay box: 270 x 352 x 97 mm Control panel: 147 x 104 x 35 mm, mounting depth approx. 35 mm
Weight	Relay box: approx. 1.9 kg Control panel: approx. 0.3 kg
Relay box outputs/inputs	2 x RJ45 jack for control panel and additional power units (sauna bus 2) 2 x RJ12 jack (sauna bus 1) 3 x RJ10 jack for sensor connection
Control panel outputs/inputs	1 x RJ45 jack for relay box 1 x connection for memory card (input/host, jack type C) Connection for power adapter 24 V DC
Display	Colour capacitive 5" touchscreen display, 800 x 480 px
Heating period limitation	Up to 6 hrs / 12 hrs / 18 hrs / 24 hrs
Temperature control	30–50°C
Sensor system	Temperature sensor for cabin temperature, with 5 m connecting cable.
Connection for fan*	Min. 5 W, max.150 W (only fan without starting capacitor), 230 V Use only fans that are suitable for phase control, otherwise the fan or the control unit can be damaged.
Connection for light 230 V AC*	Min. 5 W (20 mA), resistive load, max. 100 W, 230 V Light source with EOS transformer, max. 75 W Light source with other transformers, max. 60 VA Dimmable LED bulbs, max. 60 W
Connection for light 24 V DC*	For dimmable LED light sources using transformers such as Meanwell PWM.
Connection for dosing pump	Max. 100 kW, 230 V

Identification

Bluetooth

Bluetooth	Bluetooth LE: Bluetooth 5.0
Frequency range	2.4 ~ 2.48 GHz
Modulation methods	GFSK, PI/4-DQPSK, 8 DPSK
Maximum data rate	2 Mbps
Interface	Sauna bus
Maximum range	10 m (33 ft)
Sensitivity	30.8% / -92.5 dBm / 2 Mbps PER
RF TX power	-12 to +9 dBm

WLAN

Standard	802.11b/g/n
Bitrate	802.11n / 150 Mbps
Frequency range	2412 ~ 2484 MHz
Maximum range	20 m**

* Fan and light connections are protected by a joint 2AF fuse.

** Range depends on the installation configuration. Typical range: 20–30 m in buildings, up to 100 m in open areas.

2.4 Accessories (optional)

Accessories	Item no.
20 m connecting cable for temperature sensor	94.6281
50 m connecting cable for temperature sensor	94.6282
Connecting cable for control panel 10 m (RJ45)	94.9437
Connecting cable for control panel 25 m (RJ45)	94.9438
Connecting cable for control panel 50 m (RJ45)	94.9439
Connecting cable for control panel 100 m (RJ45)	94.9440
SBM-ECO (button)	94.6980
SBM remote start	94.5782
SBM-GLT-MOD HOME Modbus module	94.7077
SBM-GLT-KNX HOME KNX module	94.7078
EOS transformer, 75 W	94.6321
LED power adapter 60 W 24 V DC	94.9457
LED power adapter 200 W 24 V DC	94.9458
Door contact switch	94.9441
Coloured light module 40 W	94.9333
Coloured light module Extended	94.9334
Sound module	94.9335

2.5 Intended use

In conjunction with a suitable steam generator, the EOS U-Command Steam steam room control unit is intended to be used only to heat steam rooms. The steam room control unit is suitable for residential and commercial steam rooms. The relay box and control panel are intended only for mounting on the wall.



The steam room control unit is not suitable for outdoor use. It must be operated only inside buildings and may not be exposed to environmental conditions such as extreme humidity and moisture or the possible formation of condensation or corrosive substances in the ambient air, as well as other weather conditions. Similarly, excessive cold and extreme exposure to sunlight must be prevented. Protect the unit accordingly if there is an increased risk of mechanical damage.



Any use beyond this is considered improper use. Proper use also includes compliance with operating, maintenance and servicing requirements.

Foreseeable misuse

The following are considered instances of foreseeable misuse:

- The control and sensor cable plugs are plugged in incorrectly.
- The unit is operated without knowledge of or compliance with the safety instructions.
- Operating, service and maintenance requirements are not observed.
- The unit is operated after technical or other modifications are made to the relay box.
- The unit is operated by children under 8 years of age.
- The unit is operated by children 8 years of age or older, or persons with reduced mental capacity who have not been thoroughly instructed in its use.

The manufacturer is not liable for unauthorised modifications made to the equipment and damages resulting from these modifications. The person modifying the equipment alone shall bear the associated risk.

 General safety instructions,  EN-5

3

Installation

This chapter describes how to install the relay box, the control panel and the most important components.

Heat-resistant cables must be used to connect the steam generator, lighting, fan(s) or other components if they are installed inside the steam room or in the cabin wall.

NOTICE

Damage due to incorrect mounting location

The steam room control unit is not suitable for outdoor use.

- ▶ The steam room control unit must be operated only inside buildings and may not be exposed to environmental conditions such as extreme humidity and moisture or the possible formation of condensation or corrosive substances in the ambient air, as well as other weather conditions.
- ▶ Prevent excessive cold and extreme exposure to sunlight.
- ▶ Protect the unit accordingly if there is an increased risk of mechanical damage.

3.1 Power supply and data lines

All lines must be routed in such a way that they are well-protected, e.g. in a cable duct.

NOTICE

Electronics malfunctions

Routing data and power supply lines together can lead to electronics malfunctions because, e.g. because the sensor will not be detected.

- ▶ Do not route sensor and sauna bus lines together with power supply lines.
- ▶ Route separate cable ducts.

3.2 Installation work inside the cabin

At minimum, the cabin lighting and a temperature sensor must be installed inside the cabin. Additional connections are possible, depending on the amenities, e.g. coloured lights and audio systems as optional add-on modules.

All electrical installations and all connecting lines laid inside the steam room must be suitable for use in the steam room (IP65).

Temperature sensor requirements

NOTICE

Faulty switching by steam generator

Steam generation is controlled by the temperature sensor. If the temperature sensor is too close to the steam outlet, the steam generator may shut off prematurely. If the temperature sensor is too far from the steam nozzle, this can cause the temperature in the area where the steam exits to become too high.

- ▶ Do not mount the temperature sensor near the steam nozzle.
- ▶ Mount the temperature sensor in the cabin as diagonally opposite the steam outlet as possible.

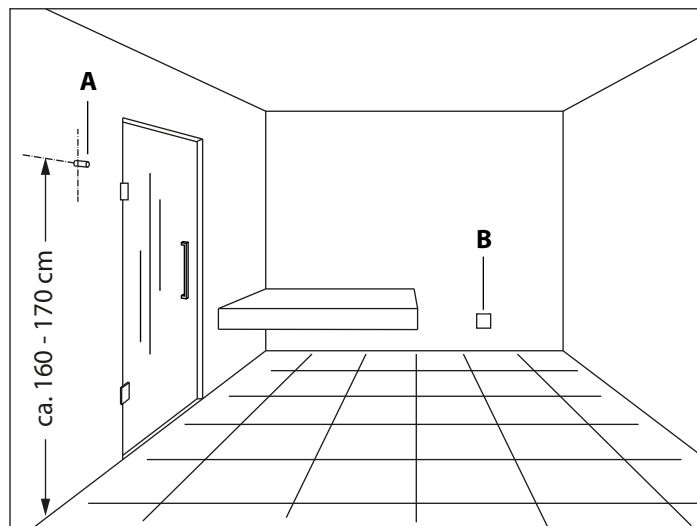

A Temperature sensor

B Steam outlet

☒ Installation configurations – temperature sensor

3.2.1 Installing the temperature sensor

Observe the installation configuration requirements for the temperature sensor.

Hardware + tools:

- Temperature sensor and connecting cables
- Drill for drilling a hole in the cabin wall
- Silicon for sealing and insulating
- Taut wire, as needed

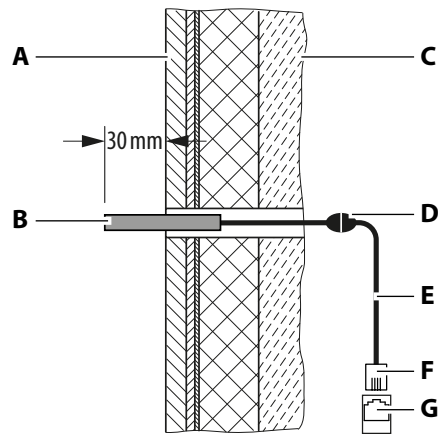

- | | |
|--------------------------------|--------------------------------------|
| A Cabin - inside wall | E Connecting line |
| B Temperature sensor | F RJ10 plug |
| C Cabin – external wall | G Sensor jack (control panel) |
| D Adapter | |

 Installation of temperature sensor

► Installing the temperature sensor in the cabin

- 1 Drill a hole (20 mm) in the cabin wall for the cable.
- 2 **NOTICE** Do not pull at the plug when routing the connecting cable(s). Doing so could damage the line. Attach the taut wire only to the cable. Route the connecting cable through the hole.
- 3 Fix the temperature sensor with silicone internally and externally.
 - ① The sensor must protrude from the cabin by approx. 30 mm.
- 4 Plug the connecting cable into the adapter and pull it through the provided conduit.
- 5 Plug the connecting cable into the control panel.

3.2.2 Installing cabin lighting

The cabin lighting can be installed anywhere, however never near hot steam that rises from the steam generator.

The relay box has one light output for 230 V AC and one light output for 24 V DC.

The light output for 230 V AC is set to inductive load by default, but light bulbs, halogen HV bulbs and other resistive loads may also be connected to it.

Cabin lighting is not included in the scope of delivery. Observe the separate installation instructions for lighting.

The light output for 230 V AC and for 24 V DC can be set in the service menu.

Requirements for light sources (230 V AC output):

- Light sources can be dimmable or non-dimmable. Light sources must be selected in the service menu.
- Minimal output 5 W
- Resistive loads, max. 100 W
- Light sources with conventional transformers, max. 60 VA
With EOS transformer, max. 75 W
- Dimmable LED bulbs, max. 60 W

Requirements for light sources (24 V DC output):

- A suitable power adapter, e.g. EOS PWM60 (item no. 94.9457)
- Dimmable 24 V DC LED bulbs,
"constant voltage" type.
- Maximum power output depends on the power adapter used.

NOTICE

Damage to the unit due to incorrect installation

Incorrect installation of the cabin lighting can damage the light sources and the control panel. In this case, the warranty becomes void.

- ▶ Do not install cabin lighting in areas with rising hot air.
 - ▶ Cabin lighting must conform to protection class IP65 and be resistant to ambient temperatures.
 - ▶ For non-dimmable light sources, make sure to select the correct setting in the service menu.
-

3.2.3 Fan

The steam room control unit has 2 controllable outputs for fans. The outputs can be used, for example, to operate a supply air fan and an exhaust fan.

The fans are not included in the scope of delivery. Observe the separate installation instructions for the fans.

Fan requirements

- Minimal output 5 W
- Maximum output 150 W
- Voltage 230 V 1N AC
- Suitable for use in steam rooms.
- It must be possible to control the rotational speed using phase control.

3.3 Relay box

The relay box must only be mounted outside of the cabin. Observe the following guidelines.

3.3.1 Requirements

⚠ WARNING

Fire hazard from overheating

Insufficient ventilation can lead to device overheating and fire. Flammable parts must not exceed a temperature of 140°C when the unit is operated as intended or in the event of a malfunction.

- ▶ Do not install relay boxes in enclosed cabinets or wood paneling.

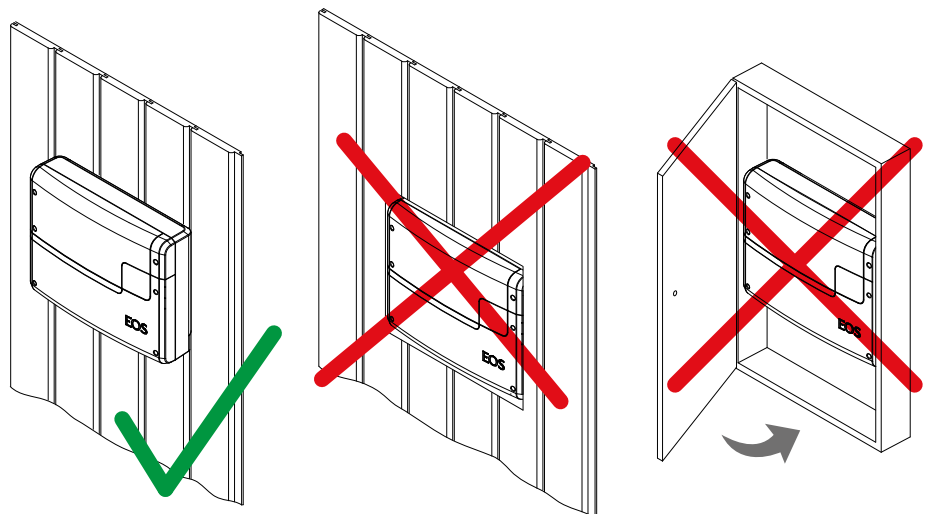

☒ Proper and improper relay box installation

Recommended installation locations are:

- Outer wall of the cabin, however not outside of the building.
- Plant room

If empty conduits for electrical installations are already installed, this dictates the position of the relay box.

All lines should be routed before installing the relay box. Connections on the relay box can be established later. Data lines must be routed and connected in such a way that they are not openly accessible.

Line routing

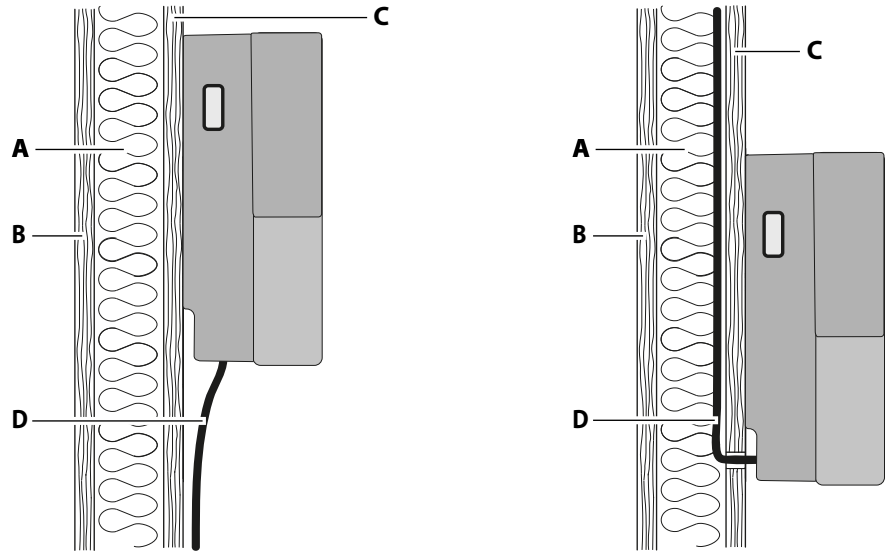

A Insulation
B Inner wall of the cabin

C Outer wall of the cabin
D Lines

 Diagram – line routing

Lines can be routed to the relay box as follows:

- The lines can be routed along the outer wall of the cabin and fed into the housing from below. If the lines are not routed through a cable duct or conduit, a strain relief must be installed.
- The lines can be routed between the insulation and the outer wall of the cabin. The lines are then passed into the housing from the rear.

Cabin insulation must be installed in such a way that the temperature in the area in which lines are routed cannot exceed 75°C.

3.3.2 Installing the relay box

Necessary steps:

- ▶ Preparing for installation, [EN-22](#)
- ▶ Removing the housing covers, [EN-22](#)
- ▶ Installing the relay box, [EN-23](#)

Tools + hardware

- Drill
- Wood screws 4 x 25 mm
- When mounting on a fixed wall: correct anchors

▶ Preparing for installation

- 1 Determine a suitable location for the installation.
- 2 Route the lines.

▶ Removing the housing covers

- 1 Loosen the 6 screws from both housing covers.

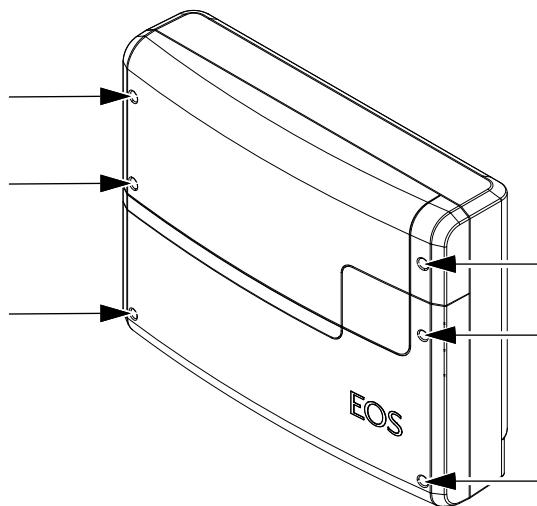

- 2 Remove both housing covers.

► Installing the relay box

- 1 Drill one (1) hole above and two (2) holes below.
- 2 Insert the anchors as needed and screw in the top screw.

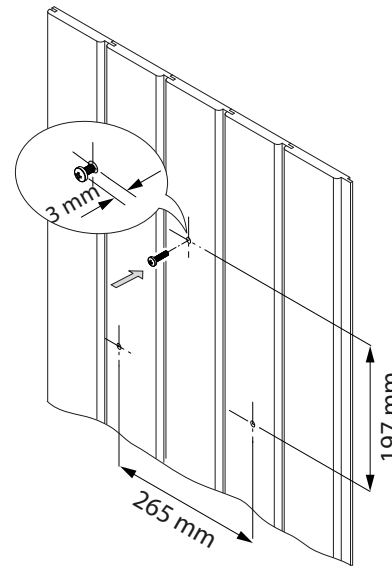

- ① Allow the screw to protrude approx. 3 mm so you can hook in the relay box.

- 3 Open the relay box conduits for the lines.

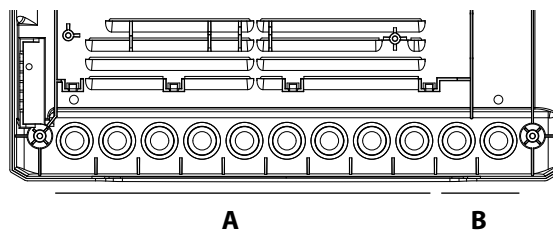

- A** Lines with power supply voltage, e.g. power supply line, heat
B Lines with low voltage, e.g. sensor line, S-Bus (sauna bus)

- ① The entries can be opened from below or from behind.

- 4 Insert the supplied bushings into the opened entries.
- 5 Route the lines through the entries.

Installation

- 6** Hook the relay box into the upper screw using the upper mounting hole (A).

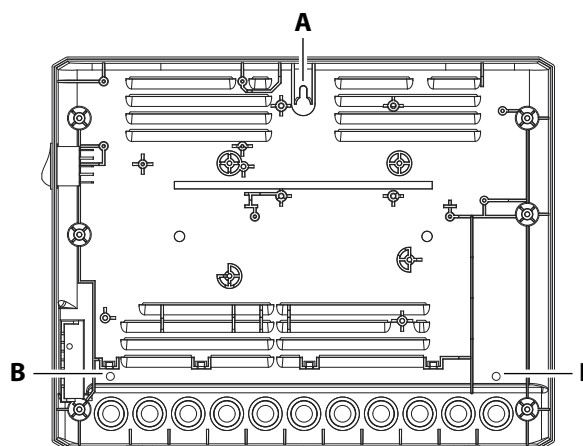

A Top mounting hole

B Lower mounting holes

- 7** Securely tighten the relay box using the two lower mounting holes.
- ① Once you have completed all installation work, you can connect the consumers and plug in the lines.
 - ① 4.2 Connections, [EN-37](#)
 - 4.3 Configuration (phase 1) of the hardware, [EN-45](#)

3.4 Control panel

The control panel can be mounted in a wall or on a wall. The scope of delivery includes a housing for mounting on the wall and a housing for mounting in the wall. The control panel can be mounted horizontally or vertically. The user interface automatically adjusts to the orientation of the control panel.

If empty conduits for electrical installations are already installed, this dictates the position of the control panel.

- Installation depth in the wall min. 35 mm
- Max. line length: 100 m.

The control panel must be installed outside of steam rooms only. The mounting location must meet the following climate condition requirements:

- Ambient temperature during operation -10°C to +60°C
- Storage temperature: -20°C to 60°C

NOTICE

Damage due to steam and humidity

Steam can escape when the cabin door is opened, which can fog over the control panel. This can lead to condensation forming in the control panel, which can cause the system to malfunction.

- ▶ Mount the control panel outside the area where steam can spread.
 - ▶ Mount the control panel on the hinge side of the door.
-

Installation

3.4.1 Installation example

The control panel can be mounted on either side of the cabin door.

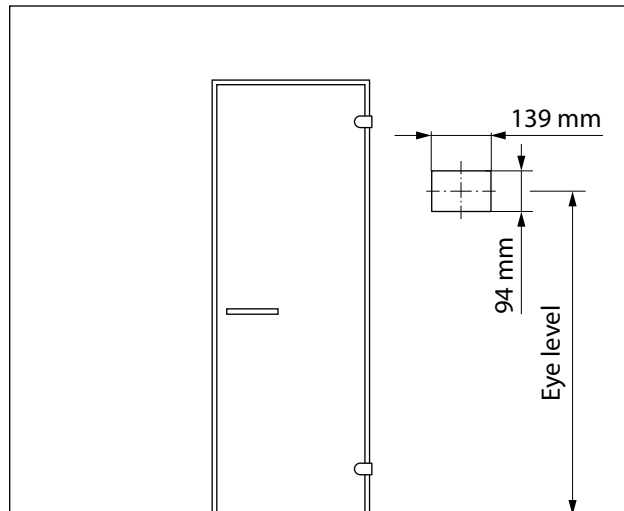

☒ Installation dimensions for the control panel (horizontal)

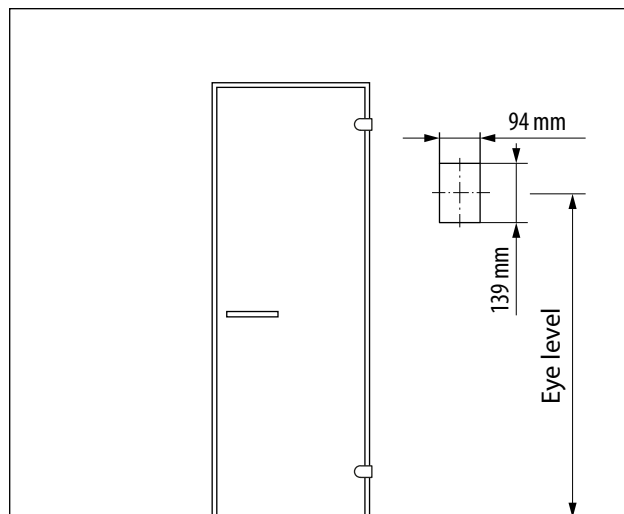

☒ Installation dimensions for the control panel (vertical)

3.4.2 Line routing

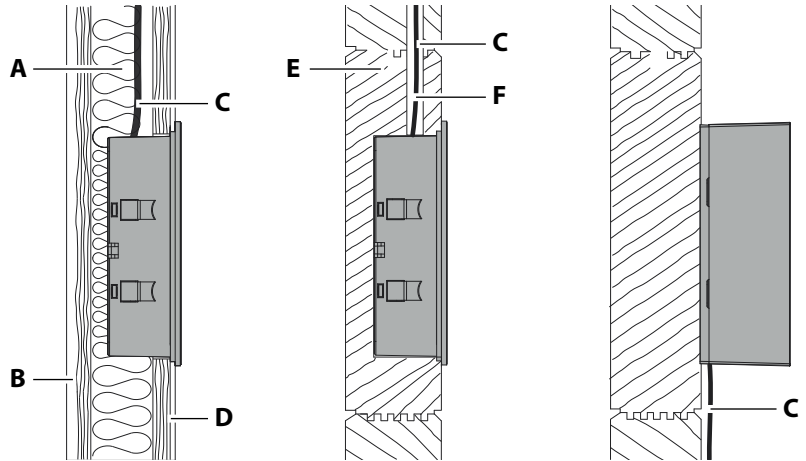

- | | |
|----------------------------------|----------------------------------|
| A Insulation | D Outer wall of the cabin |
| B Inner wall of the cabin | E Wood wall |
| C Line | F Cable duct |

 Diagram – line routing

The line can be routed to the control panel as follows:

- The line can be routed between the insulation and the outer wall of the cabin and fed into the housing from above.
- The line can be routed in a wood wall and fed into the housing from above. To do this, cable ducts must be installed in the wood wall.
- The line can be routed along the outer wall of the cabin and fed into the housing from below. The line should be protected by a cable duct.

Cabin insulation must be installed in such a way that the temperature in the area in which lines are routed cannot exceed 75°C.

3.4.3 Mounting in the wall

To mount the control panel in a wall, a wall cut-out must be created. The control line is then routed to the control panel. A housing for mounting the control panel in the wall is included in the scope of delivery.

Necessary steps:

- ▶ Create wall cut-out and lay the control line, [EN-28](#)
- ▶ Mount the housing for mounting in the wall, [EN-29](#)

Tools + hardware

- Saw for wall cut-out
- Phillips screwdriver
- Taut wire, as needed

▶ Create wall cut-out and lay the control line

- 1 Determine a suitable location for the installation.
- 2 Prepare a wall cut-out:

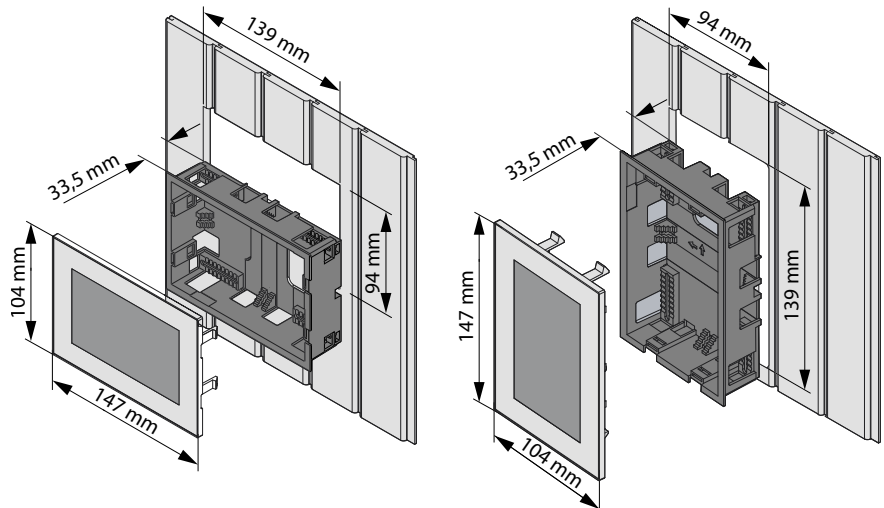

- 3 **NOTICE** Do not pull at the plug when routing the control line. Doing so could damage the lines. Attach the taut wire only to the cable. Route the control line from the relay box to the control panel.

► Mount the housing for mounting in the wall

- 1 **NOTICE** The control panel's housing and display are not mounted upon delivery. Do not drop the control panel. The display's glass plate cannot be replaced. Remove the protective film from the panel after mounting is completed.

Slightly loosen the screws of the 4 clips in the housing.

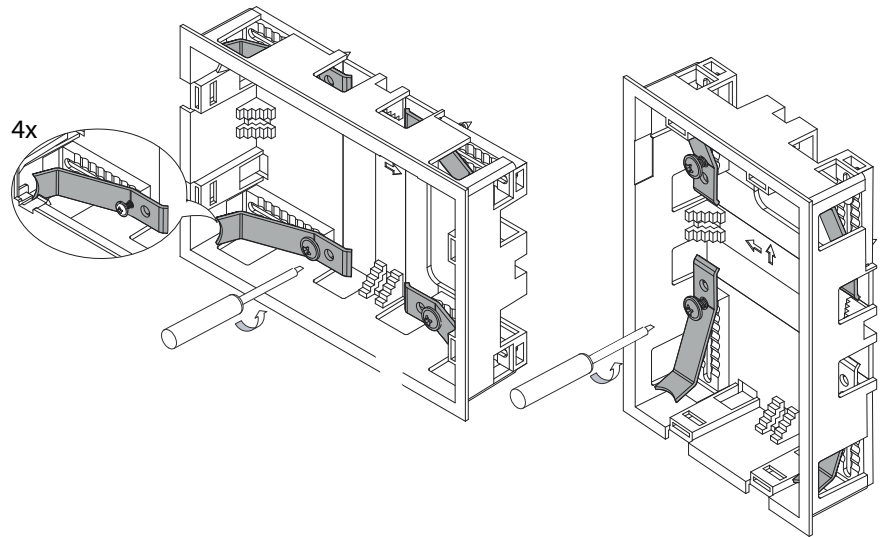

- 2 As an alternative to clips, the housing can also be fixed by using screws. Screw the screws into the holes on the 4 sides to fix the housing.

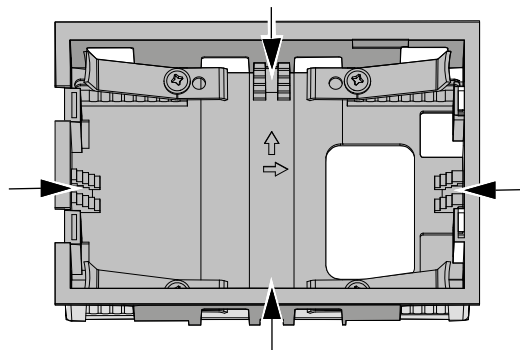

- 3 After routing, pull the control line through the opening in the housing.
 - ① Do not pull the control line too taut so that you can easily remove the control panel at a later time.
- 4 Set the housing in the prepared wall cut-out.
 - ① Observe the label on the housing (oben/up).
- 5 Turn the 4 clips outward and tighten the screws.
 - ① The housing must sit firmly in the wall cut-out.

3.4.4 Mounting on the wall

The control panel can be mounted on a wall with screws. A housing for mounting the control panel on the wall is included in the scope of delivery.

Tools + hardware

- Phillips screwdriver
- Drill
- Wood screws 4 x 25 mm
- When mounting on a fixed wall: correct anchors

► Mount the housing for mounting on the wall

- 1 **NOTICE** The control panel's housing and display are not mounted upon delivery. Do not drop the control panel. The display's glass plate cannot be replaced. Remove the protective film from the panel after mounting is completed.

Drill four holes.

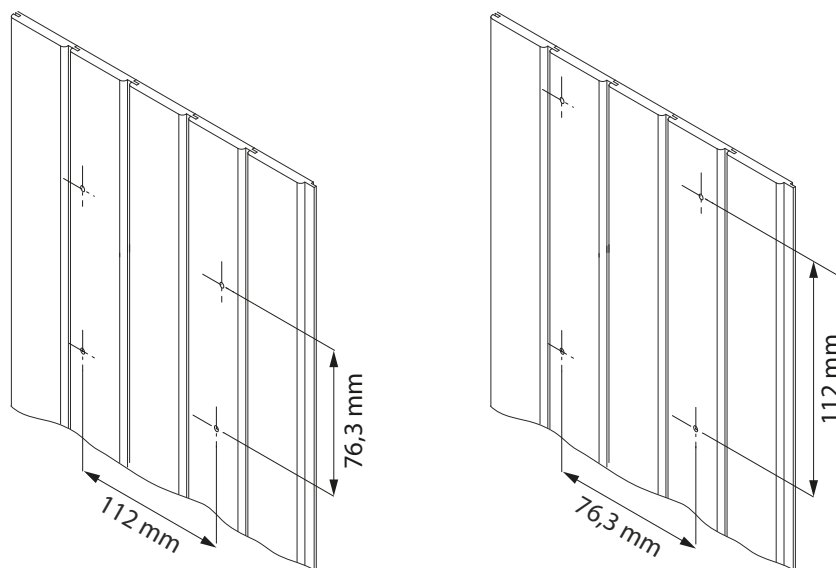

- 2 Use anchors if necessary.
- 3 Unscrew the 4 clamps in the housing for mounting in the wall and remove the 4 clamps.
- 4 Insert the housing for mounting in the wall into the housing for mounting on the wall.
- 5 After routing, pull the control line through the opening in the housing.

6 Screw the housing to the wall.

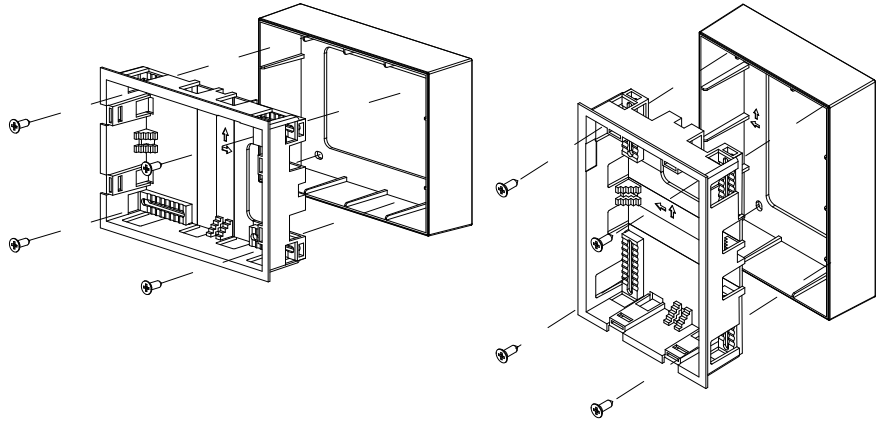

① Observe the label on the housing (oben/up).

3.4.5 Completing control panel mounting

After the housing has been mounted, the control line is connected, the split ferrite is attached, and the control panel is inserted. These steps are identical for both mounting in and on the wall.

► Connecting the control line

1 Connect the control line with the RJ45 plug to the RJ45 socket.

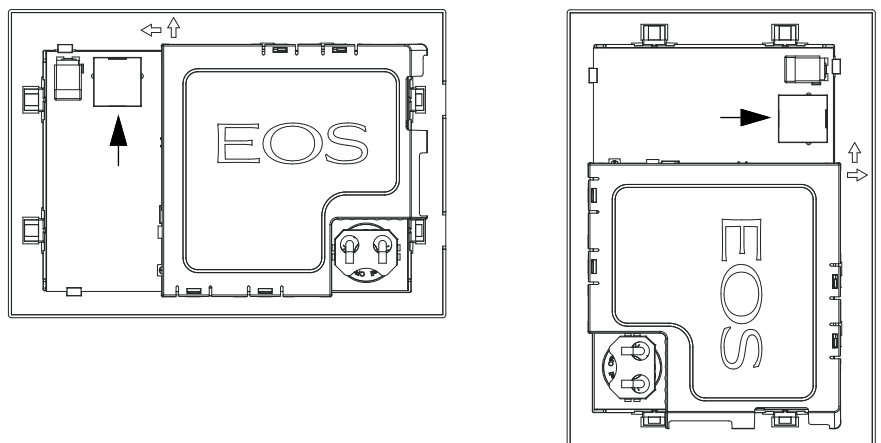

Installation

► Attaching the split ferrite

- 1 Attach the split ferrite to the control line in front of the control panel.

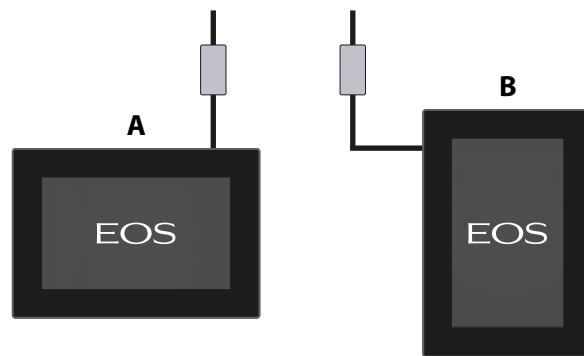
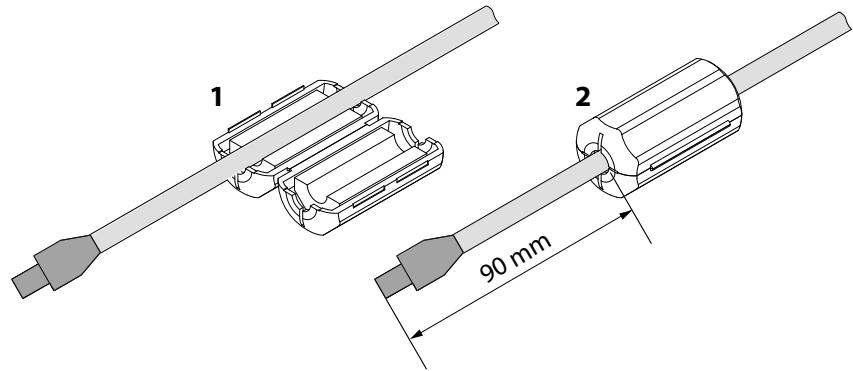

ⓘ For solid wood log planks, a cut-out must be made for the split ferrite.

► Inserting the control panel

- 1 Place the control panel directly in front of the housing.
 - ① Observe the label on the frame of the control panel (oben/up).
 - ① The cable connection must point downwards.
- 2 Press the control panel carefully into the housing with a consistent amount of pressure until it audibly snaps into place.

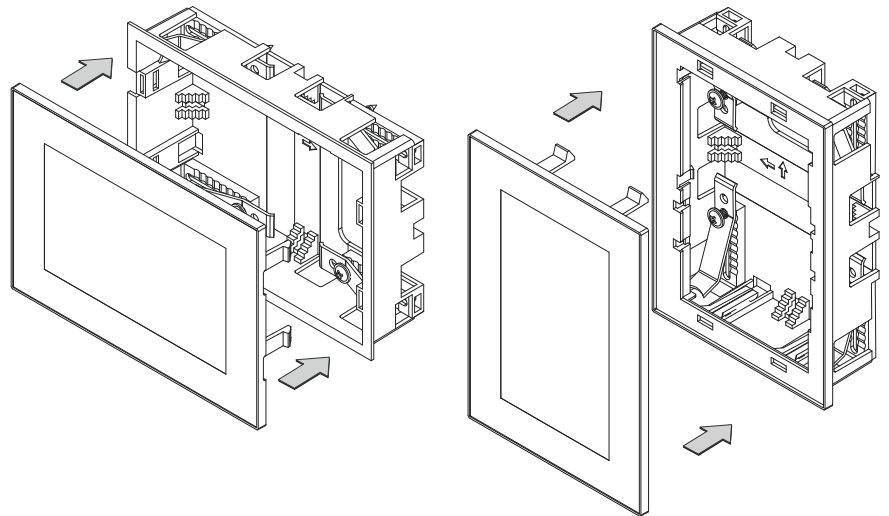

- 3 Remove the foil from the control panel.

3.5 Control panel removal

The control panel can be removed if needed.

► Removing the control panel

- 1 Insert both removal tools in the slots on the side of the control panel.

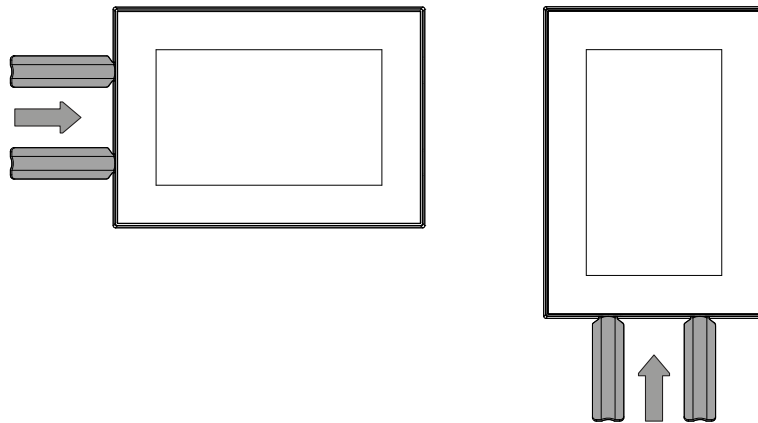

- 2 Lift and remove the control panel carefully.

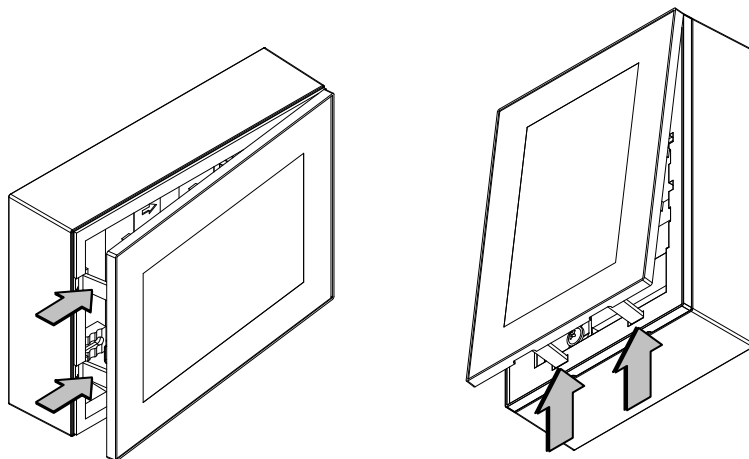

4

Electrical installation

This chapter describes how to connect the relay box's circuit board lines. For information on setup of the control panel, see chapter Commissioning, [EN-48](#).

Recommended installation sequence

Before commencing installation, ensure that the relay box, the control panel, and the sensor are mounted. Furthermore, all cabin work must be complete: Steam generator, light, etc.

Complete installation in the following sequence:

- Insert the data lines in the relay box.
- Connect the load lines (steam generator, light, fan, etc.) to the relay box.
- Check the cabin address, configuration, and heating period limitation, and set them with the jog dial, see 4.3 Configuration (phase 1) of the hardware, [EN-45](#).
- Establish connection to the power supply.
- Switch on the relay box and control panel.
- Configure additional settings at the control panel, e.g. target temperature.

Note that the jog dial settings must be checked and configured before connecting to the power supply. Always disconnect the device from the power supply before making any subsequent modifications.

Electrical installation

4.1 Circuit board assignment

The steam generator, cabin lighting, fan and module are connected to the relay box. All connected modules are controlled by the control panel.

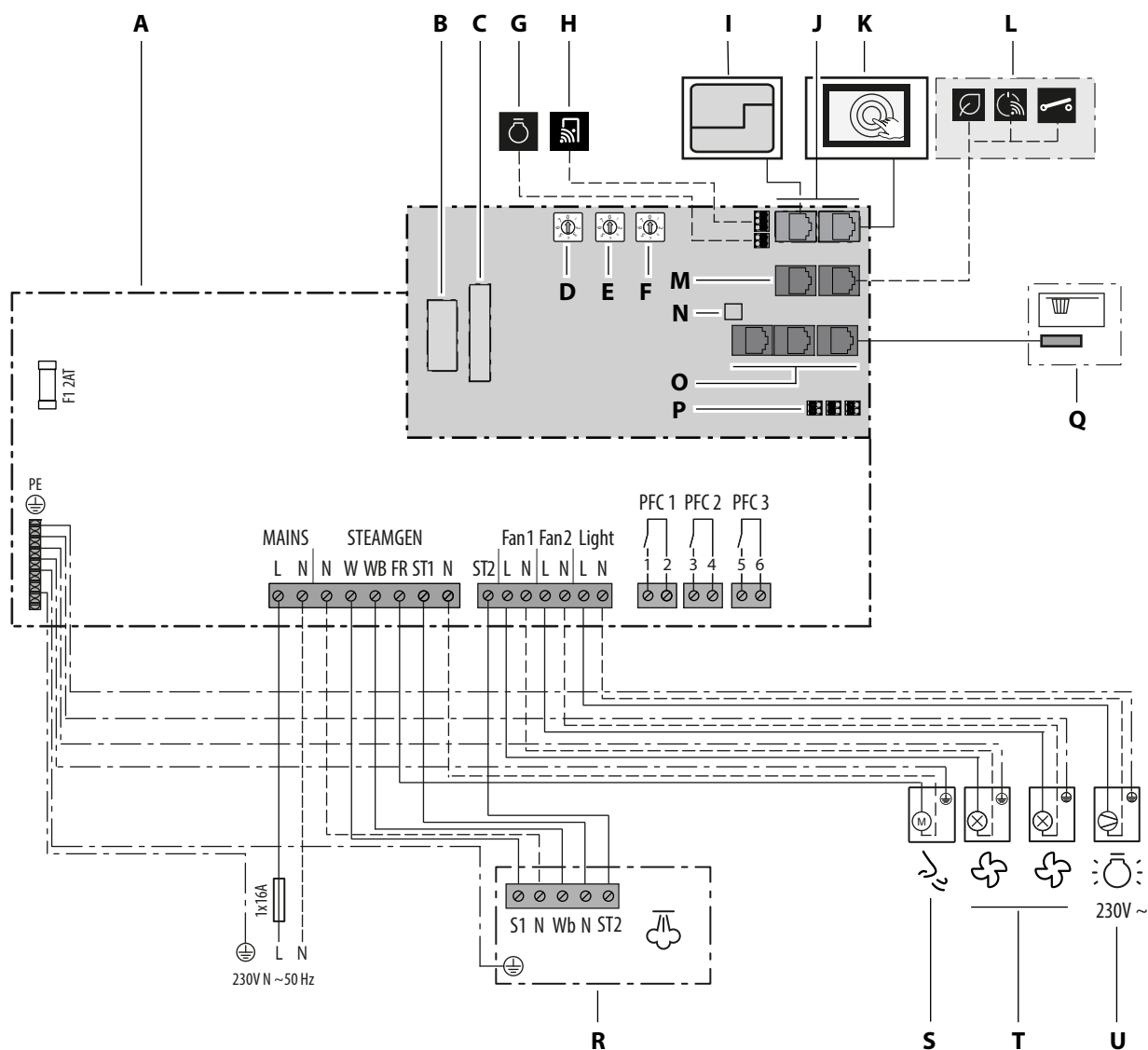

- | | | |
|---|--|--|
| A Circuit board for relay box (diagram) | I Modules | P Safety temperature limiter connection |
| B Slot for sound module | J RJ45 jack (sauna bus 2) | Q Temperature sensor |
| C Slot for coloured light module | K U-Command Steam control panel | R Steam generator |
| D Jog dial Config | L Add-on modules | S Dosing pump |
| E Jog dial ADR | M RJ12 jack (sauna bus 1) | T Fan |
| F Jog dial TIME | N Dip switch jumper | U Light output 230 V AC |
| G Light output 24 V DC | O RJ10 jack (sensor) | |
| H Door sensor connection | | |
|  Schematic view of connections | | |

4.2 Connections

The relay box is connected with a live current of 230V 1N ~ 50/60 Hz and fused separately with 1 x 16 A.

- A 16 A cut-out with at least K characteristic must be used for fuse protection.
- As a rule, only a fixed connection may be connected to the power supply. There must be a device that disconnects the unit from the power supply on all poles with a contact opening width of at least 3 mm.
- Heat-resistant cables must be used for the steam generator, light, and fan connections.

4.2.1 Control panel

The control panel is connected to a free RJ45 socket (sauna bus 2) using the Ethernet cable included in the scope of delivery.

- Maximum line length: 100 m
- Lines up to 100 m are available as an optional accessory. See 2.4 Accessories (optional), [EN-13](#)

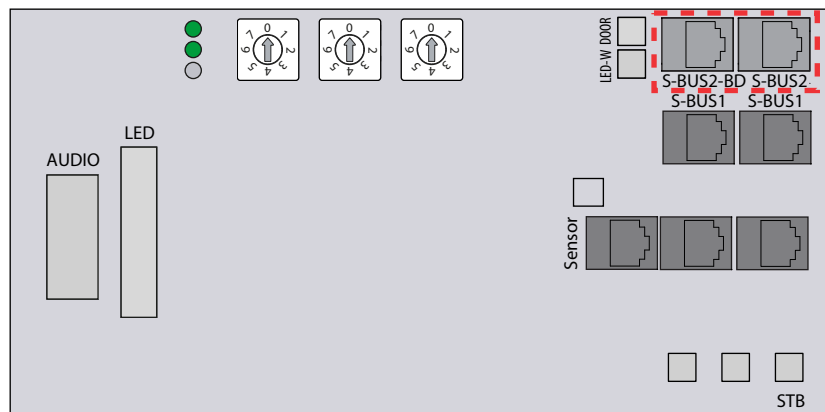

Control panel connection

Electrical installation

4.2.2 Additional relay box

An additional relay box for controlling a second cabin is connected to an available RJ45 jack (sauna bus 2) using the Ethernet cable included in the scope of delivery.

The cabin address must be set to control two cabins. See 4.3 Configuration (phase 1) of the hardware, [EN-45](#).

- Maximum line length: 100 m
- Lines up to 100 m are available as an optional accessory. See 2.4 Accessories (optional), [EN-13](#)

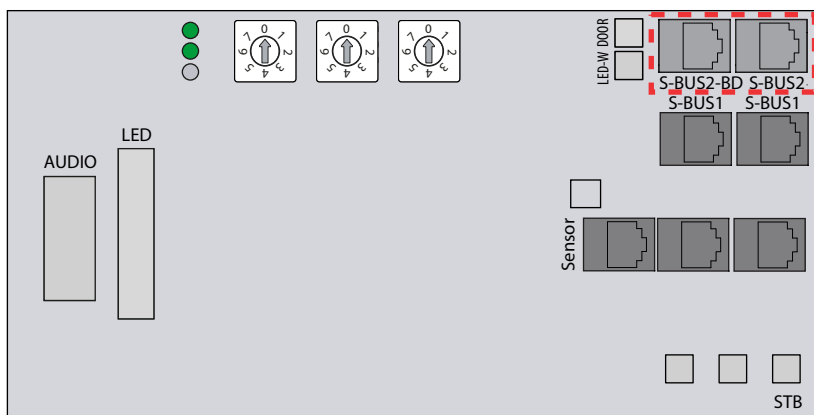

Connection for additional relay box

4.2.3 Add-on modules

Optional expansion modules (e.g., remote start, SBM-IR, or SBM-GLT-KNX) are connected to an available RJ12 jack (sauna bus 1) using the RJ12 cable included with the respective module.

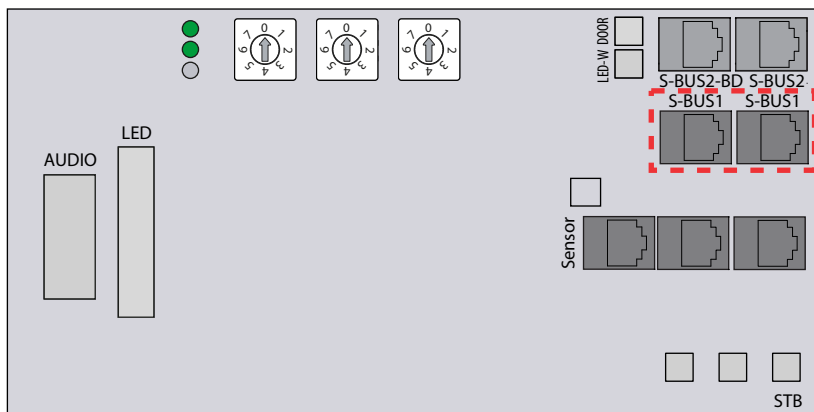

Connection for add-on modules

4.2.4 Temperature sensor

The air temperature in the steam room is adjusted using the control panel. The set values are checked by a temperature sensor and controlled by the relay box.

Circuit board connections

The temperature sensor is connected to one of the three RJ10 sensor jacks using an RJ10 plug. Only one temperature sensor can be connected to the steam room control unit. The steam room control unit automatically detects the connected temperature sensor.

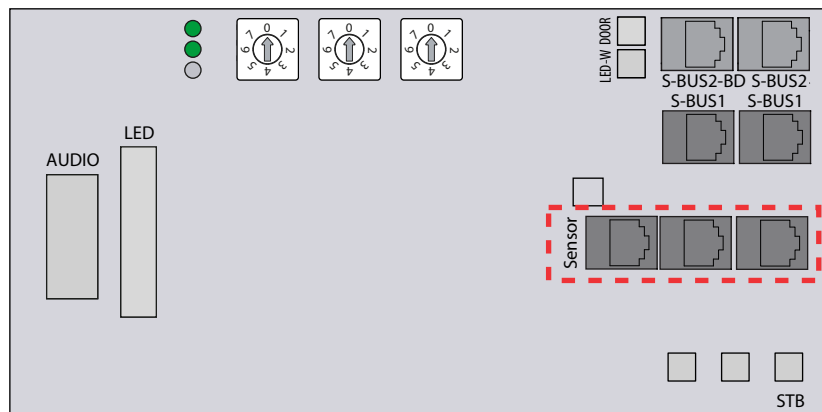

Connecting the temperature sensor

4.2.5 STB terminal

The STB terminals can be used to connect other components (e.g., emergency stop button). To do this, the factory-installed jumper on the relevant STB terminal must be removed.

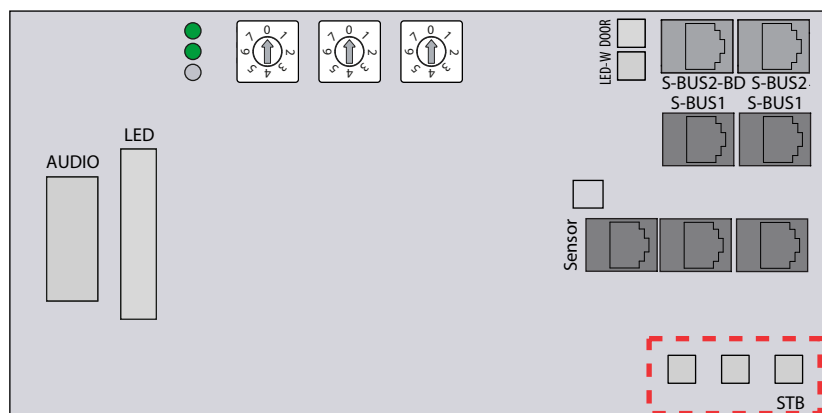



STB terminal

Electrical installation

4.2.6 Door contact switch (optional)

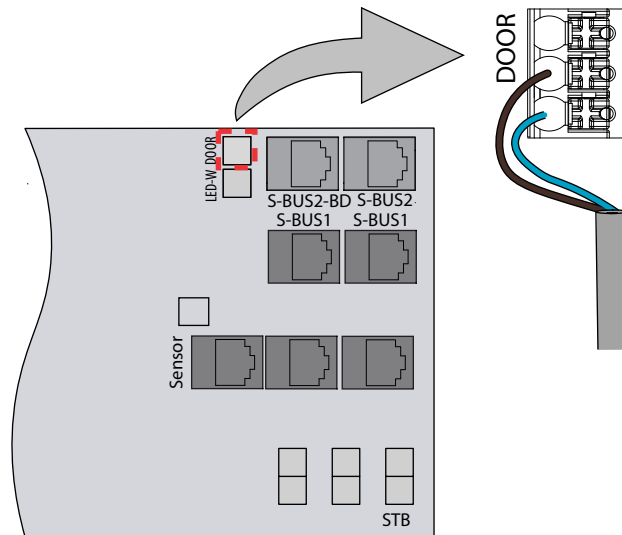
An optional door contact switch can be connected for monitoring the cabin door.



 Door contact switch connection

4.2.7 Coloured light module and sound module (optional)

The following modules can be connected to the circuit board (optional).

- Coloured light module 40 W
- Coloured light module Extended
- Sound module

Observe the separate installation instructions when installing and connecting modules.

4.2.8 Steam generator

The steam generator also requires its own power supply. Only one control signal is transmitted via the relay box.

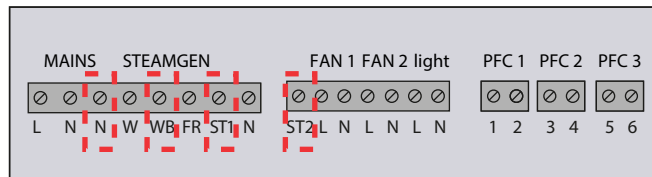

☒ Connection for steam generator

4.2.9 Dosing pump

A dosing pump can be connected for dispensing essence.

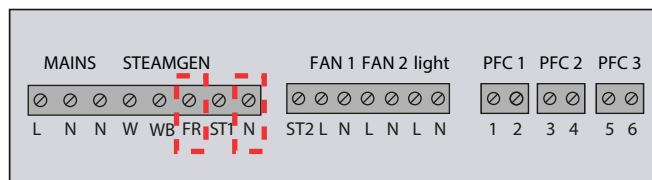

☒ Connection for dosing pump

4.2.10 Fan

The *Fan 1* and *Fan 2* terminals may each be occupied by one cable.

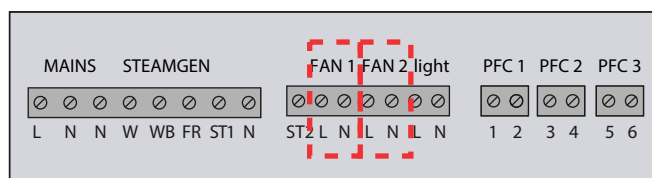

☒ Connection for fan

Fans with a power rating of 5 W to 150 W can be connected to *Fan 1* and/or *Fan 2* terminals, e.g. supply and exhaust fans. The fans may not have starting capacitors.

Fan and light connections are protected by a joint 2AF fuse.

Electrical installation

4.2.11 Light

The relay box has one light output for 230 V AC and one light output for 24 V DC. The light output for 230 V AC and for 24 V DC can be set in the service menu.

230 V AC

Light sources that operate on 230 V alternating current can be connected to the 230 V AC light output. The *light* terminals may each be occupied by one cable.

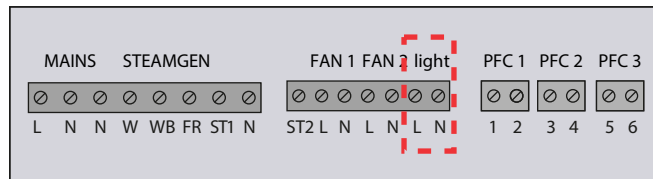

☒ Connection for light 230 V AC

The terminals for *light* may be used only for cabin lighting. Fan and light connections are protected by a joint 2AF fuse.

24 V DC

Dimmable low-voltage lights with dimmable transformers (e.g., Meanwell PWM) can be connected to the 24 V DC light output. The transformer must be supplied separately with power.

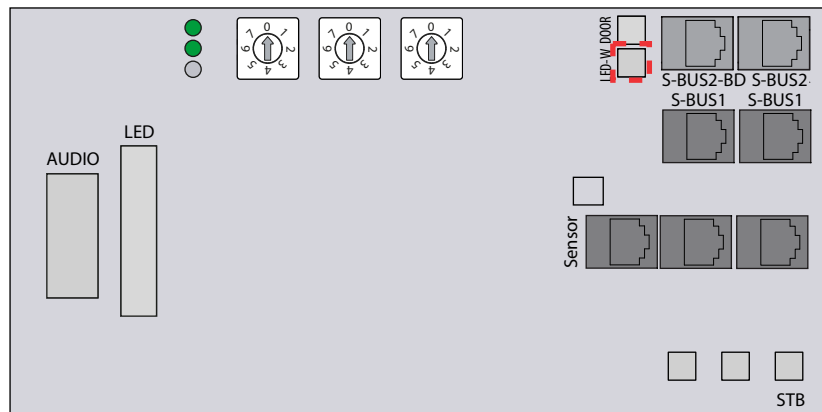

☒ Connection for light 24 V DC

4.2.12 Potential-free contacts

External devices can be connected via the potential-free contacts on the relay box circuit board and linked to steam generator functions. Observe the installation instructions and documentation for the device when retrofitting additional devices.

NOTICE

Property damage due to short circuiting

The supply line can short circuit if you use the power supply connections L1, L2 or L3 to supply the electric circuits connected to the potential-free contacts.

- ▶ Use the steam room control unit's power connections exclusively for the steam generator.
- ▶ Do not connect additional devices to the power supply connections of the steam room control unit.
- ▶ Observe the maximum load of the potential-free contacts.

Maximum load

Resistive load/alternating current	Max. 250 V AC/10 A
Inductive load/alternating current	500 VA
Direct current	Up to 30 V DC max. 10 A (300 W)
	Up to 110 V DC max. 0.3 A (33 W)
	Up to 220 V DC max. 0.12 A (26.4 W)

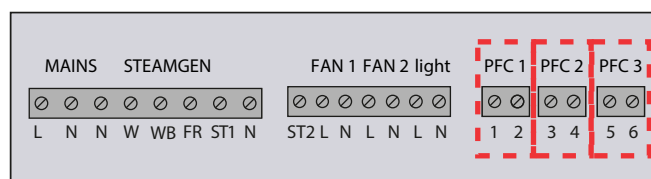











 Connection for potential-free contacts

Electrical installation

Settings for potential-free contacts can be made in the service menu. Make settings for the potential-free contact to stipulate when the connected device should be switched on.

The following options are available to make settings:

-  Potential-free contacts are deactivated.
-  Manual switching on the display or via remote control
-  Switch ON if light is on.
-  Switch ON if light is off.
-  Switch ON until target temperature has been reached.
-  Switch ON, once target temperature has been reached.
-  Switch ON, once actual temperature drops below 50°C.
-  Switch ON if cabin is on.
-  Switch ON if cabin is off.
-  Switch ON if there is a malfunction.

4.3 Configuration (phase 1) of the hardware

For accurate control of the cabin, the jog dials for the safety system, the cabin address, and the heating period limitation must be set. The housing cover must be removed for the following steps. See ► Removing the housing covers, EN-22

Setting the safety system

Set the **Config** jog dial:

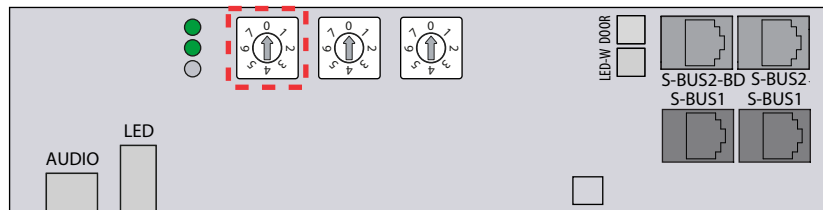

Position	Setting
0	Private operation
1, 2, 3	Currently not functional
4	Commercial operation

Setting the cabin address

Set the **ADR** jog dial:

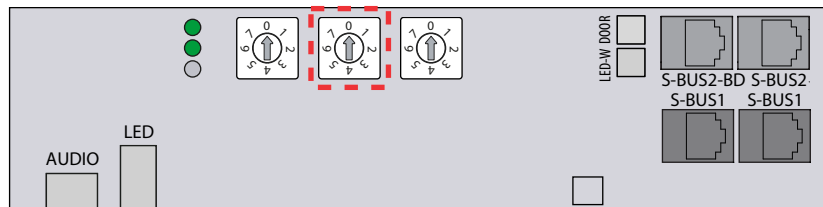

Position	Setting
1	Cabin address 1 (factory setting)
2	Cabin address 2

- If two relay boxes are connected for controlling two cabins (multi-cabin installation), the second cabin must be set to cabin address 2.

Electrical installation

Setting the heating time limitation

Set the **TIME** jog dial:

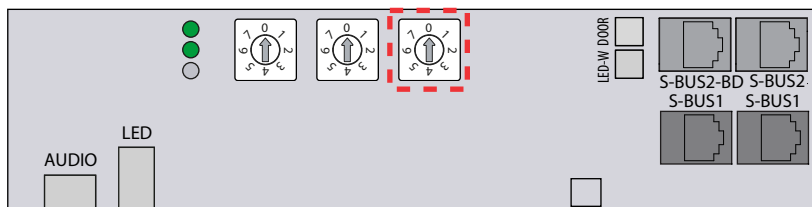

Position	Setting
0	6 hours (factory setting)
1	12 hours
2	18 hours
3	24 hours

- When operated privately, the heating period is limited to 6 hours, regardless of the set heating period limitation.
- When operated commercially and when the cabin is constantly supervised, the heating period limitation can be set to up to 24 hours.

4.4 Completing electrical installation

Lines must be connected before closing the housing cover.

When the unit is properly connected and switched on, two green LEDs will flash on the CPU board soon after start. These LEDs signal normal communication.

This means that a correct installation is visible even if the relay box and the control panel are far apart.

► Closing the housing cover

- 1 Switch on the relay box and check if the green LEDs are flashing.
 - a) Green LEDs flashing: remount the housing covers.
 - b) Green LEDs not flashing: troubleshoot and rectify the problem.

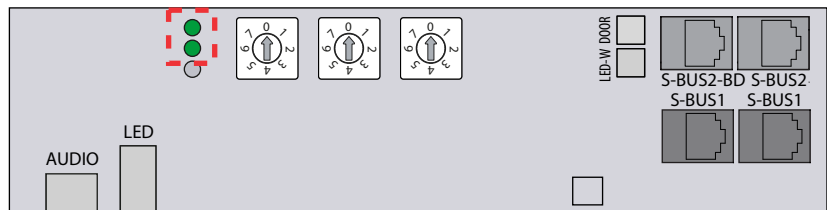

- 2 First put the lower then the upper housing cover in place.
- 3 Screw in the 6 screws.

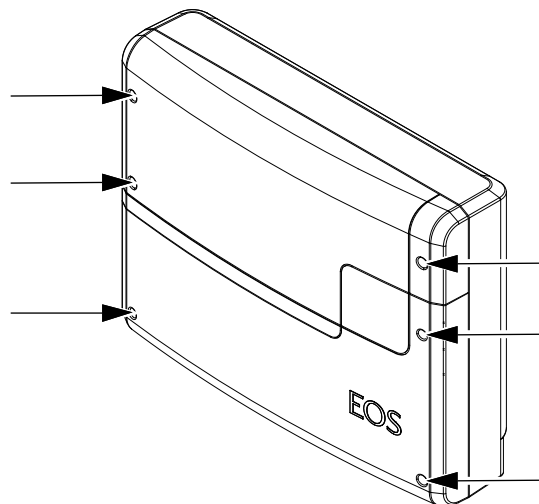

Commissioning

In order to commission the steam room, the cabin must be switched on at the control panel. If the display is blank, the relay box might be switched off.

The control panel automatically switches to standby mode once connection to the relay box has been established and it is connected to the power supply.

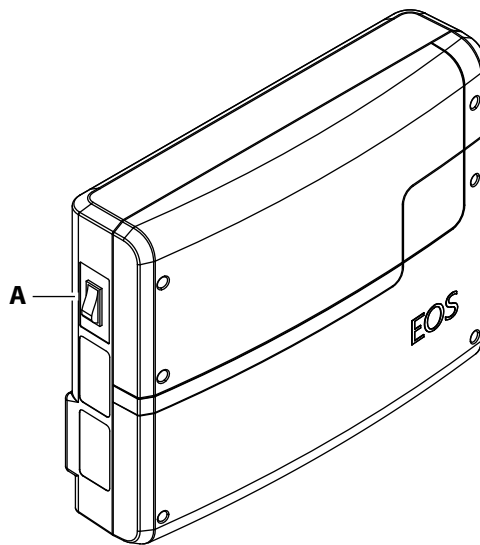

A Unit switch on relay box

A unit switch is located on the left side of the relay box.



Position I:
Relay box is switched on (factory setting).
The relay box is ready for operation in standby mode.

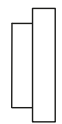

Position 0:
Relay box is completely switched off.
Parts of the circuit board are still under current.



Position II:
Cabin lighting is switched on, relay box is switched off.
Position for maintenance and cleaning.

5.1 Configuration (phase 2) of the software

The steam room control unit must be configured prior to initial commissioning or after a reset. The program guides you through the required steps.

► Configuring the steam room control unit



- 1 Select the desired language.
- 2 Set the time.
- 3 Set the date.
- 4 Make additional settings as needed.
- 5 Close configuration with the  button.

5.2 Light output

The light output can be set in the service menu as follows.

- **230 V output, dimming function inactive (factory setting):**
For non-dimmable light sources.
- **230 V output, dimming function active:**
For dimmable light sources. Use only suitable LED light sources and LED transformers with phase control.
- **24 V output, dimming function active:**
For dimmable LED light sources in combination with LED power supply units such as the Mean Well PWM Series.

► Setting the light output

- 1 Press and hold the  button for 3 seconds.
- 2 Enter code **5349** and confirm.
- 3 Press the  button.
- 4 Specify the light output.



Commissioning

5.3 Door contact switch (optional)

You can turn cabin door monitoring, which uses the door contact switch, on or off.

- If the cabin door remains open for 3 minutes, the **Door open** warning message will appear.
- If the cabin door remains open, the heating will shut off after 5 minutes.

► Setting the door contact switch

- 1 Press and hold the  button for 3 seconds.
- 2 Enter code **5349** and confirm.
- 3 Press the  button.
- 4 Turn the door contact switch on or off.

5.4 Pairing with EOS Cloud

The steam room control unit can be connected with the EOS Spa Control app and EOS Cloud. Use the EOS Spa Control app to manage a wide range of steam room functions.

Requirements:

- The EOS Spa Control app is installed on your mobile device.
- Your EOS user account is created.
- WLAN and Bluetooth are enabled on your mobile device.

► Performing pairing

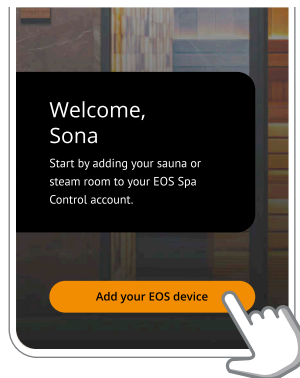

1 Add a cabin.

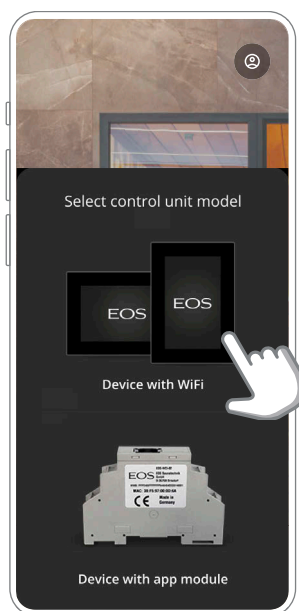

2 Select a device with WLAN.



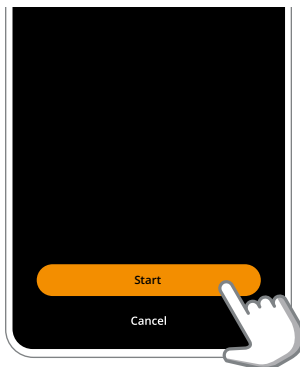

Commissioning

- 3 Tap the  button on the control panel.
- 4 Tap the  button on the control panel.
- 5 Tap the  pairing button on the control panel.
① A 60-second countdown is displayed.
- 6 Pairing starts.

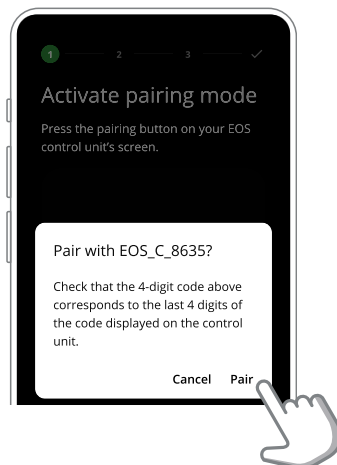

- 7 Confirm the detected EOS unit.



- 8 Select the WLAN network and enter the password.
- 9 Assign a cabin name.
① The WLAN connection can be verified on the control panel.
See 6.8.9 WLAN and cloud,  EN-72.

5.5 Troubleshooting

Error messages on the control panel indicate operating statuses and fault conditions.

Error – error message	Reason	Solution
Display is blank	No power supply.	Switch on the relay box.
		Check the relay box's power supply connection.
		Check fuses.
	No connection to the relay box.	Check the connection to the control panel.
Temperature sensor fault	Connecting cable to control panel >100 m.	Use only EOS cables (<100 m).
	No connection to the temperature sensor.	Check the cable and connections.
	Sensor is defective.	Replace the sensor.
	Error with the safety circuit	No connection.
No bus communication.	Too many add-on modules connected.	Connect modules with separate power adaptor.
	Bus connection plug not plugged in.	Plug in plug.
	Bus cable damaged.	Replace bus cable.
	Unit not detected.	Set unit address for the module.
Other errors	Software error.	Restart unit. Contact technical support.

6

Operation

6.1 User interface

The user interface can be displayed horizontally or vertically depending on the orientation of the control panel. The user interface may differ from the illustrations shown depending on the features.

6.1.1 Elements

Setting controller

Values can be set by tapping and swiping.

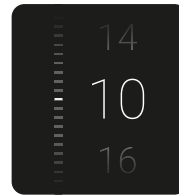
Setting controller

Values can be set by swiping.

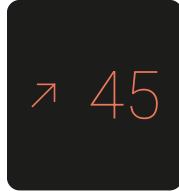
Actual value

Temperature

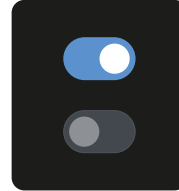
Toggle

On (top)
Off (bottom)

Selection

Selected (top)
Deselected

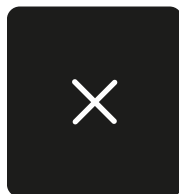
Back

Close window

6.1.2 Main screen



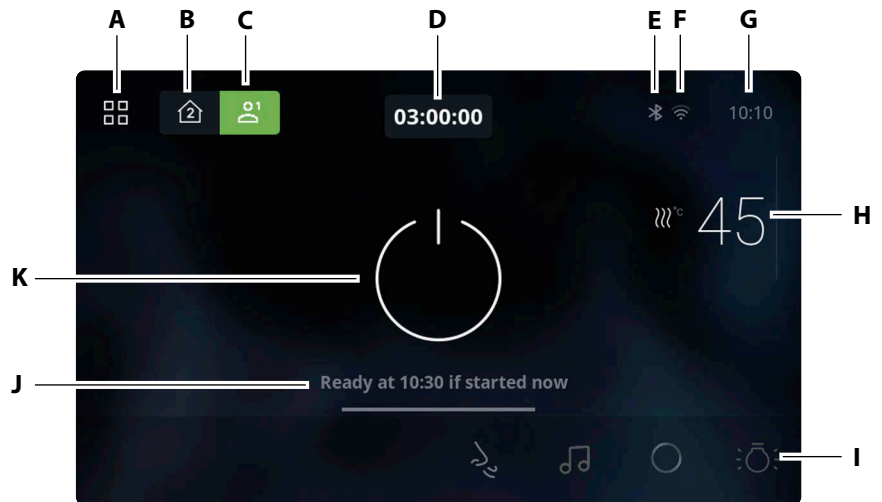

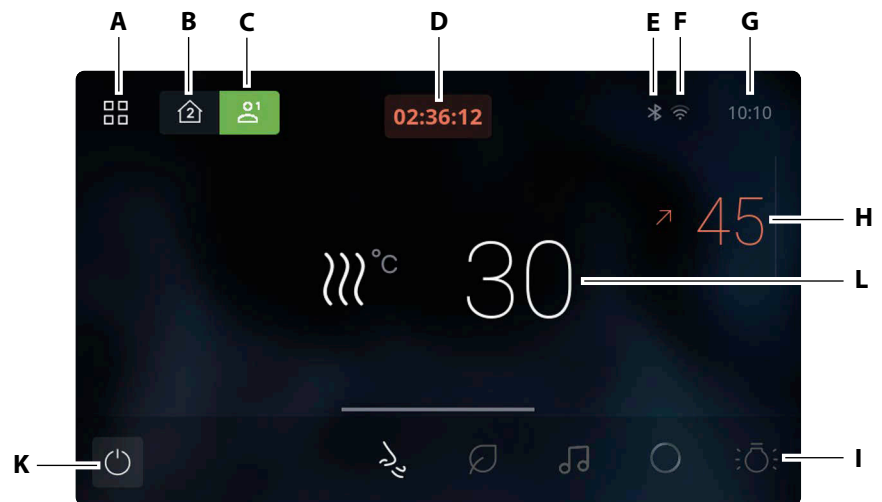

Use the main screen to make settings for any cabin that has been configured.

Standby mode



Operating mode



- | | |
|--|---|
| A  User menu | G Time |
| B  Home screen | H Target temperature |
| C  Profile | I Multi-function bar |
| D (Remaining) heating period | J Status information |
| E  Bluetooth | K  On/off |
| F  Wi-Fi | L Actual temperature |

6.1.3 Home screen for multi-cabin installation

If two cabins are installed, use the multi-cabin installation home screen to select and monitor the configured cabins. Once you have selected a cabin, the main screen of the selected cabin appears.

Cabins switched off

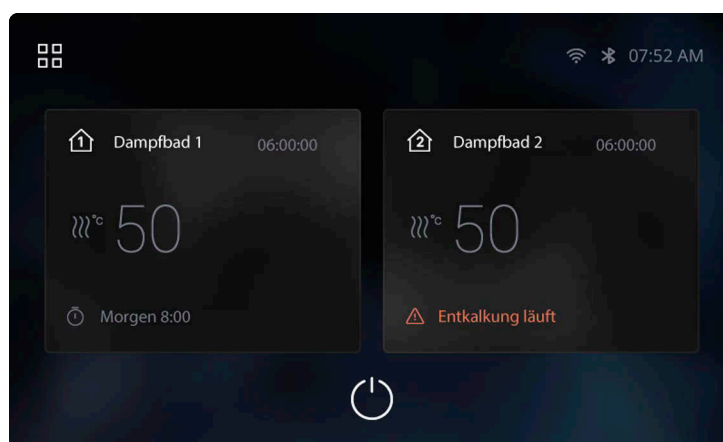

Cabins switched on

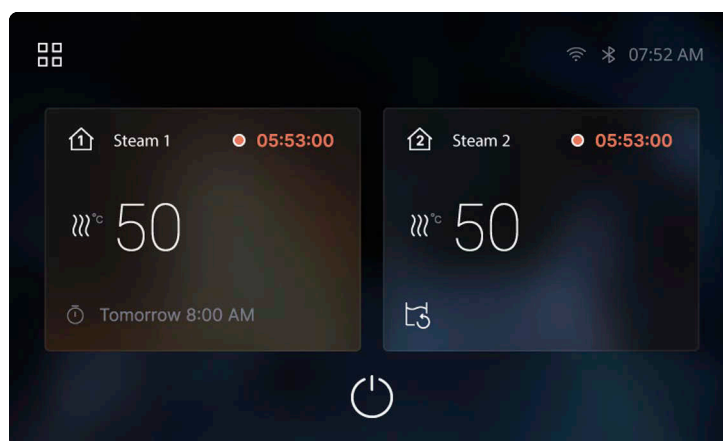

Both views are available only in multi-cabin installations.

6.1.4 Multi-function bar

The multi-function bar is continuously displayed in Standby mode. In Operating mode, you can display the multi-function bar by swiping up from the bottom of the screen.

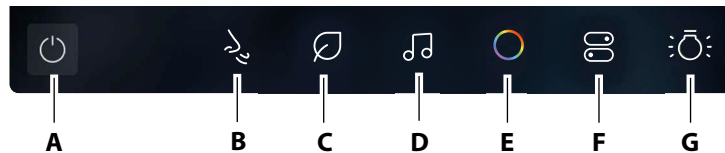

- | | |
|--|--|
| A  On/off | E  Coloured light (optional) |
| B  Essence dosing (optional) | F  Potential-free contacts |
| C  ECO mode | G  Cabin lighting |
| D  Music player (optional) | |

6.2 Switch on cabin

► Switch on cabins individually

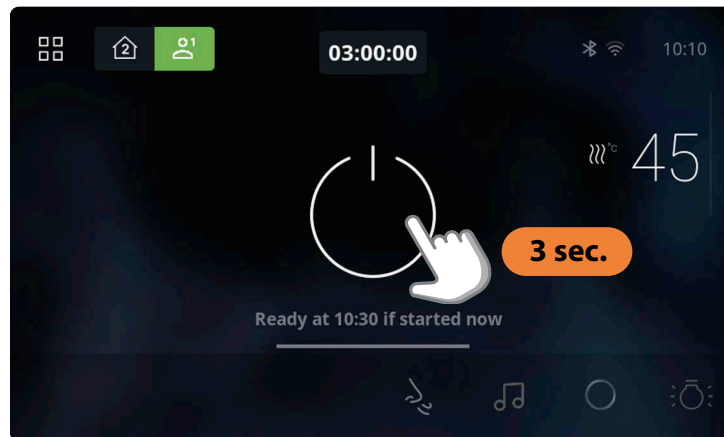

► Switch on cabins simultaneously (in multi-cabin installations)

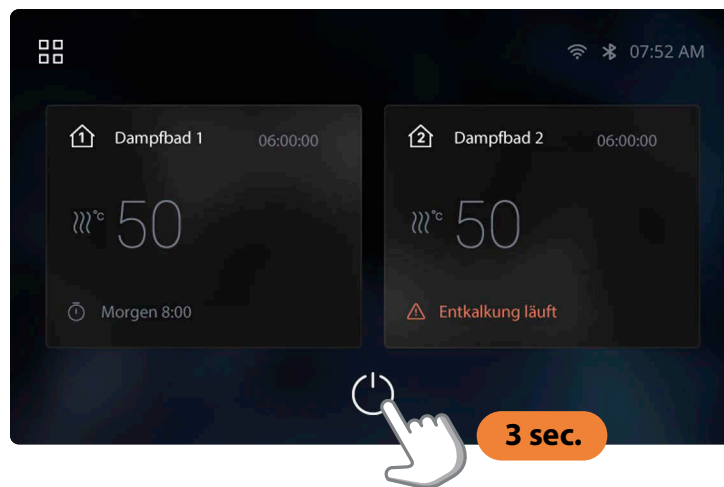

6.3 Switch off cabin

- After operation, the fan is activated for 30 minutes. This dries the cabin. Then the cabin switches to Standby mode.
- If necessary, tap the  button again to end the drying process prematurely.

► **Switch off cabins individually**

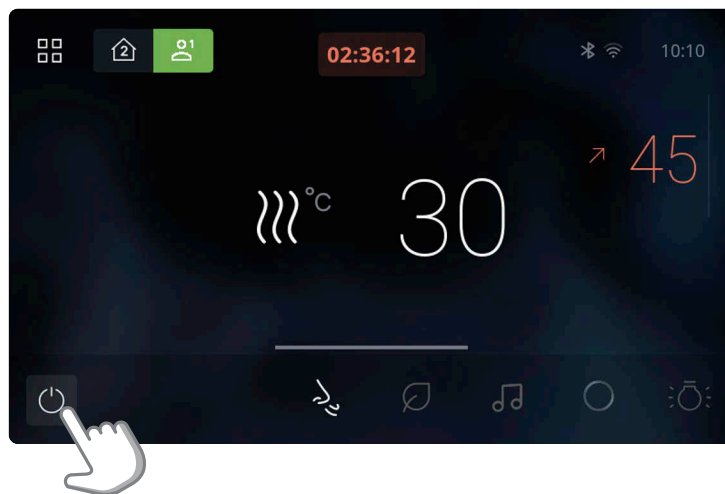

► **Switch off cabins simultaneously (in multi-cabin installations)**

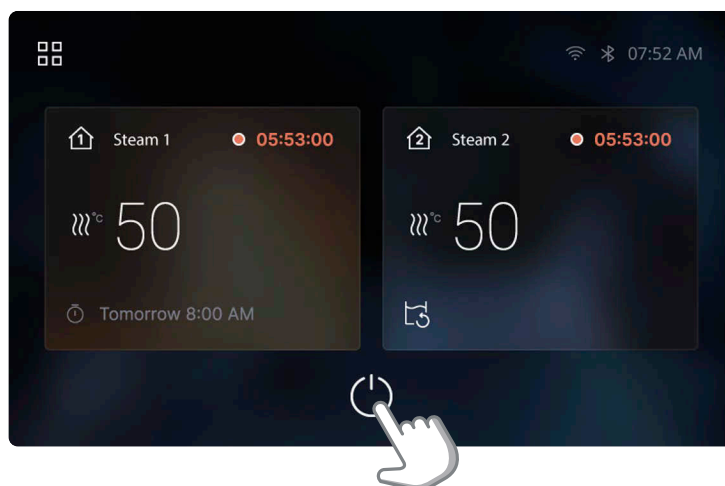

6.4 Temperature

You can set the temperature in Standby mode and in Operating mode.

► Setting the temperature in Standby mode

1

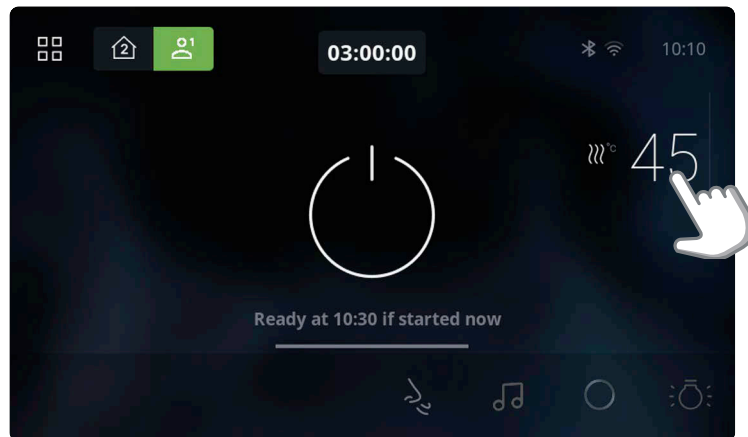

2

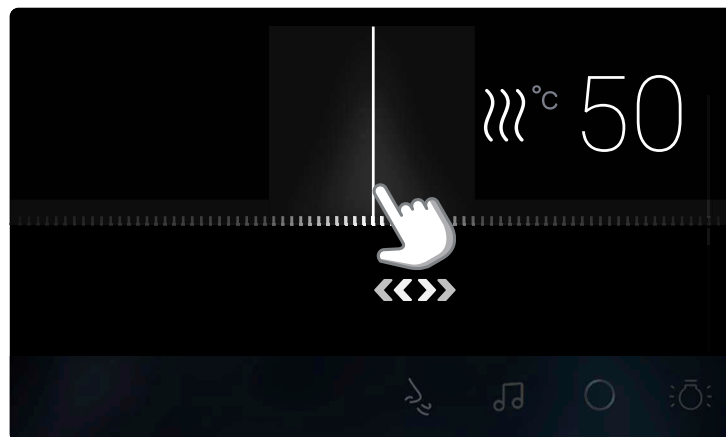

▶ **Setting the temperature in Operating mode**

1

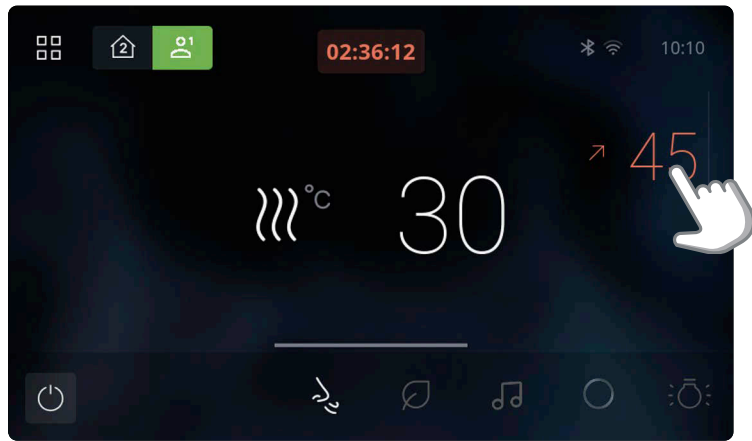

2

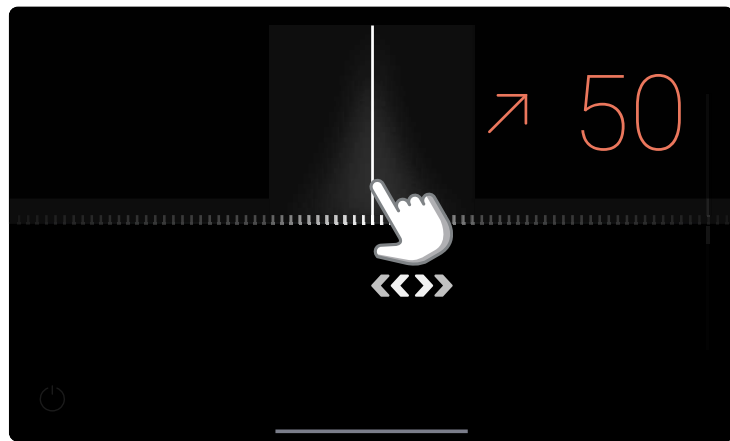

6.5 Cabin lighting

Use the control panel to switch cabin lighting on and off, and dim it.

► Switch cabin lighting on/off

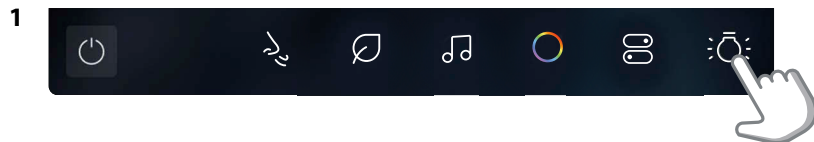

► Dimming the cabin lighting

Cabin lighting can only be dimmed if the light output in the service menu is set to dimmable light sources and dimmable light sources are connected.

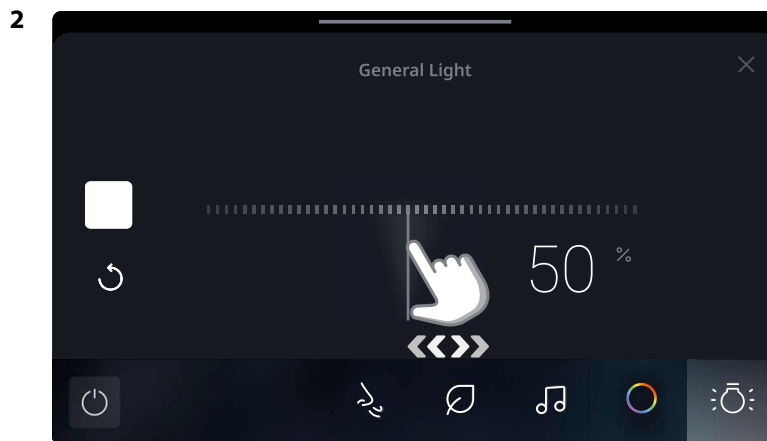
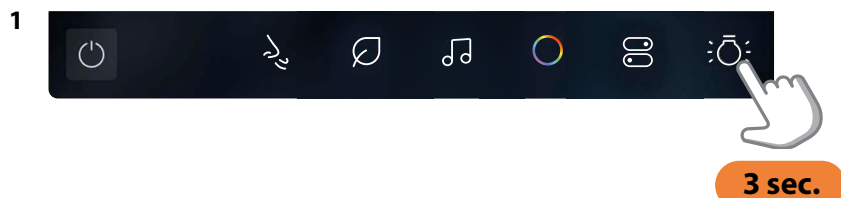

6.6 Switching on potential-free contacts

Potential-free contacts allow you to use the steam room control unit to switch external devices on or off. .

- You can assign a unique icon to each potential-free contact. See 6.8.4 Potential-free contacts icon,  EN-69.
- Use the EOS Spa Control app to assign a custom name to the potential-free contacts.

► Switching on potential-free contacts manually

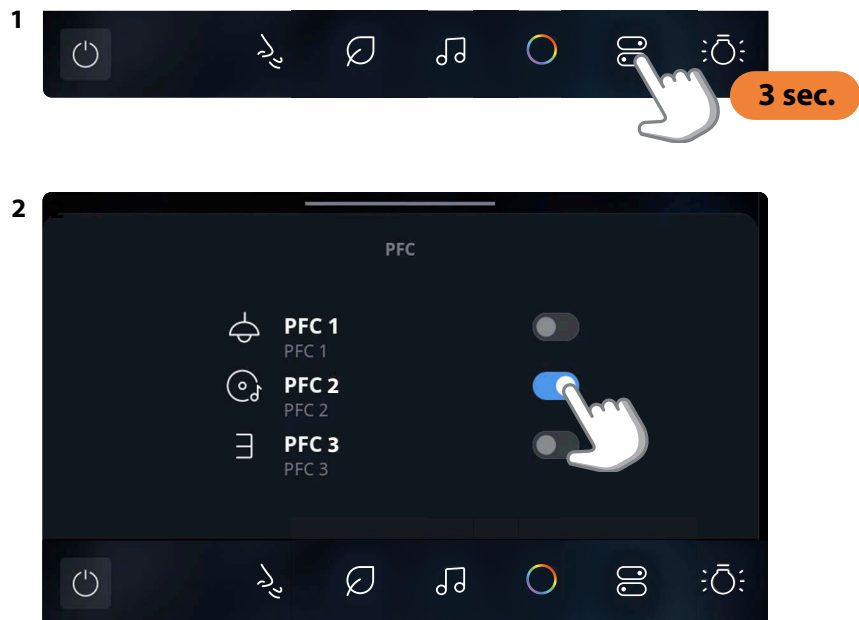

6.7 Profiles

Four profiles are available. . The adjustable values depend on the cabin features.

See ► Setting profiles, EN-68.

► Selecting a profile

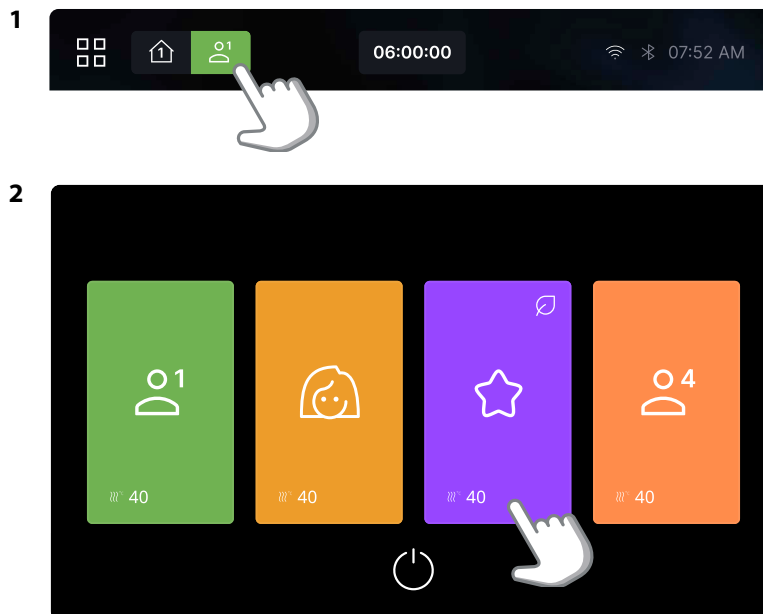

6.8 User menu

Access the user menu with the  button.

6.8.1 Heating time

You can use the heating period setting to specify how long the cabin should be supplied with steam.

Private operation



- Max. 6 hours.

Commercial operation

- Max. 12 hours if the cabin is not being monitored.
- Max. 18 hours if the cabin is being monitored.
- Unlimited heating period if the cabin is being monitored. Please observe the local statutory intermission times.

After operation, the fan is activated for 30 minutes. This dries the cabin.

► Setting the heating period











- 1 Tap the  button.
- 2 Tap the  button.
- 3 Set the desired heating period in hours and minutes by adjusting the setting controller.
 - ① The heating period can be set in operation mode.
 - ① Alternatively, select the heating period directly on the main screen.
- 4 Confirm your selection with the  button.
 - ① After switching on the cabin, the remaining heating period is displayed at the top centre. It indicates how long the cabin will remain switched on.

6.8.2 Pre-set timer



The pre-set timer allows you to set programs with an automatic start and end time. You can set one-time programs and weekly programs. Weekly programs are only available with commercial use systems. You can set up to two programs for each day of the week.

When setting the pre-set timer, please observe any applicable standards for the maximum heating period.



► Adding a program to the pre-set timer

- 1 Tap the  button.
- 2 Tap the  button.
- 3 Tap the  button.
- 4 Choose whether the program should run once or weekly.
 - a)  One-time program
 - b)  Weekly program
- 5 If you chose weekly, select the desired day of the week for the program.
- 6 If you chose weekly, choose whether to set one or two programs.
 - a)  Set one program.
 - b)  Set two programs.
- 7 Set the desired start time with the setting controller.
- 8 Confirm your selection with the  button.
- 9 Set the desired end time with the setting controller.
- 10 Confirm your selection with the  button.
- 11 Select the sauna type.
- 12 Set the desired temperature with the slider.
- 13 Confirm your selection with the  button.

► Switching the program on/off

- 1 Tap the  button.
- 2 Tap the  button.
- 3 Use the toggle to switch the program on the desired day of the week on or off.





► Deleting all programs

- 1 Tap the  button.
- 2 Tap the  button.
- 3 Tap the  button.
- 4 Confirm or cancel the prompt.
 - a) ✓ Delete all programs.
 - b) ✗ Cancel the prompt.





6.8.3 Profiles

Four profiles are available. . The adjustable values depend on the cabin features.

You can make the following settings for the profiles.

-  1 Change the colour and icon.
-  °C Set the temperature.
-  Set the brightness of the cabin lighting.
-  Set the coloured light.
- PFC Switch potential-free contacts on/off.





► Setting profiles

- 1 Tap the  button.
- 2 Tap the  button.
- 3 Configure the profile as desired and confirm your selections with the  button.
 - ① The settings will be automatically applied to the profile.
- 4 If needed, tap the  button to reset the profile settings.

6.8.4 Potential-free contacts icon

You can assign a unique icon to each potential-free contact. Use the EOS Spa Control app to name each potential-free contact as well.

► Assigning an icon to a potential-free contact





- 1 Tap the  button.
- 2 Tap the  button.
- 3 Select the potential-free contact with the  button.
- 4 Select an icon for the potential-free contact.
- 5 Confirm your selection with the  button.

6.8.5 Operating data

You can access the following operating data for your steam room control unit.

- Log file (heating curve)
- Service interval (factory set)
 - Private use: 500 hours
 - Commercial use: 2500 hours
- Firmware version (with update information)
- Retailer and Service contact information

► Accessing operating data



- 1 Tap the  button.
- 2 Tap the  button.
- 3 Select operating data with the  button.
- 4 Tap the  button to return to the selection.

Operation

6.8.6 Language

You can change the user interface language at any time.

► Changing the language

- 1 Tap the  button.
- 2 Tap the  button.
- 3 Select the desired language.
- 4 Confirm your selection with the  button.

6.8.7 Keypad lock

You can lock the system to prevent unauthorised access. The keypad lock can be set to different modes. The keypad lock is protected with a PIN code.

NOTICE



No access to the control unit

The control unit cannot be used if the PIN is not known.



- Save the PIN in a safe place.
- Contact your retailer or EOS Service if you lose your PIN.

Available setting	Standard	Holiday cottage	Holiday park	Total lock
Switch on steam room	✓	✓	✓	✗
Switch off steam room	✓	✓	✓	✓
Remote control	✓	✓	✓	✓
Switch lighting on/off	✓	✓	✓	✓
Dimming the light	✓	✗	✗	✗
Setting the temperature	✓	✓	✗	✗
Set heating period (0:30 hr to 6:00 hr)	✓	✓	✓	✗
Change unit settings	✓	✗	✗	✗

► Setting the keypad lock

- 1 Tap the  button.
- 2 Tap the  button.
- 3 Select the mode for the keypad lock in the sub-menu.
- 4 Assign a PIN code.
① The PIN code can be selected and must be 4–7 characters long.
- 5 Confirm your selection with the  button.

► Unlocking the unit



- 1 Tap the  button.
- 2 Tap the  button.
- 3 Select the sub-menu for unlocking.
- 4 Enter the PIN code.
- 5 Confirm your selection with the  button.

6.8.8 Bluetooth

You can manage the Bluetooth connection for the steam room control unit.

- Display the Bluetooth unit name.
- Establish a connection to a new unit.
- Display the connected unit.
- Delete the connected unit.

► Managing the Bluetooth connection



- 1 Tap the  button.
- 2 Tap the  button.

6.8.9 WLAN and cloud

You can display the status of the WLAN connection (WLAN network name SSID, connection status).

For information on WLAN connections, see 5.4 Pairing with EOS Cloud,  EN-51.

► Displaying the WLAN connection





- 1 Tap the  button.
- 2 Tap the  button.

6.8.10 Time and date

You can set the time and date on the steam room control unit.

- **Time:** hours/minutes
- **Date:** year/month/day

► Setting the time and date

- 1 Tap the  button.
- 2 Tap the  button.
- 3 Select the time or date with the  button.
- 4 Set the time or date.
- 5 Confirm your selection with the  button.

6.8.11 Display

Brightness

You can set the display brightness in %.

► Setting the brightness

- 1 Tap the sub-menu for brightness.
- 2 Set the display brightness with the setting controller.
- 3 Confirm your selection with the  button.

Sleep mode

You can set the amount of time after which the control panel switches from Screensaver mode to Sleep mode when it is not being used. Sleep mode may be used only if heating is off. In sleep mode, the display is completely black.

Tap on the display to end sleep mode.

► Setting sleep mode

- 1 Tap the sub-menu for Sleep mode.
- 2 Set the number of hours and minutes after which the control panel switches to Sleep mode.
- 3 Confirm your selection with the  button.

Screensaver

You can set the amount of time after which the control panel displays the screensaver when it is not in use. The screensaver shows the time and date. Tap on the display to end the screensaver.

► Setting the screensaver

- 1 Tap the sub-menu for the screensaver.
- 2 Set the number of hours and minutes after which the screensaver is displayed.
- 3 Confirm your selection with the  button.





6.9 Coloured light (optional)

Use the multi-function bar to switch on and adjust the optional coloured light.

► Switching on the coloured light

- 1 Tap the  button on the multi-function bar.









► Setting the coloured light

- 1 Press and hold the  button in the multi-function bar for 3 seconds.
- 2 Tap the  button to set a specific colour.
- 3 Set the light colour with the top setting controller.
- 4 Set the brightness with the bottom setting controller.
- 5 Tap the ,  or  button to set a colour gradient.
- 6 Set the interval time with the top setting controller.
- 7 Set the brightness with the bottom setting controller.

6.10 Music player (optional)

The optional music player enables you to play music in the cabin. To use the music player, a playback device must be connected via Bluetooth to the steam room control unit.

► Playing music



- 1 Press and hold the  button in the multi-function bar for 3 seconds.
- 2 Start the music with the  button.
- 3 Stop the music with the  button.
- 4 Select the previous or next track with the  and  buttons.
- 5 Set the volume with the setting controller.
- 6 Tap the  button to mute the music.
- 7 Tap the  button to play the music in a continuous loop.
- 8 Tap the  button to shuffle the tracks.

6.11 Essence dosing (optional)

Use the multi-function bar to switch on and adjust the optional essence dosing.

- **Dosing duration:** Operating time of dosing pump for each dose, 1 to 30 seconds
- **Dosing interval:** Interval for essence dosing, 1 to 30 minutes

► Setting the essence dosing

- 1 Press and hold the  button in the multi-function bar for 3 seconds.
- 2 Set the dosing duration (duration – 1 second).
- 3 Set the dosing interval (interval – 1 second).
- 4 If necessary, press and hold the  button to test the dosing pump.

► Switching the essence dosing on/off

- 1 Tap the  button on the multi-function bar.

6.12 Updating firmware

New firmware versions are downloaded via over-the-air (OTA) updates and installed on the steam bath control unit.

If an update fails or does not completely install, the steam room control unit will automatically restart. After restart, the following options can be selected on the control panel.

- **Boot:** The steam room control unit starts with the previous firmware version. The update must be repeated manually.
- **Update:** The update process is repeated.
- **Pairing:** The steam room control unit can be connected directly to the EOS Cloud (e.g., if there were previous Wi-Fi issues).

7

General terms and conditions of service

(T&C, Dated 08-2018)

I. Scope

Unless otherwise agreed in writing for specific instances, these terms and conditions of service shall apply to service operations, including reviewing and remedying complaints. All our existing or future legal relationships shall be governed solely by the following terms and conditions of service. We do not recognise any of the customer's conflicting terms and conditions unless we have given our express written consent to their applicability.

We hereby expressly object to any of the customer's terms and conditions included in the customer's General Terms and Conditions of Business or order confirmation. Unconditional acceptance of order acknowledgments or deliveries shall not be construed as any form of acknowledgment of such terms and conditions. Ancillary agreements or amendments must be confirmed in writing.

II. Costs

The customer shall bear the following costs in connection with services rendered:

- Mounting/dismantling and electrical (de-)installation
- Transportation, postage and packaging
- Function testing and troubleshooting, including inspection and repair costs

There shall be no third-party billing.

III. Performance and cooperation obligations

The customer shall provide assistance free of charge to the manufacturer in rendering services.

In the case of a warranty claim, the manufacturer shall provide spare parts necessary for servicing free of charge.

IV. Service visit by the manufacturer

Services rendered on site by an employee of the manufacturer must be agreed in advance.

If the main reason for the service visit is not the fault of the manufacturer, any costs incurred shall be charged to the customer after the service visit and must be paid by the customer in full within the agreed payment term.

V. Liability

The manufacturer shall assume liability in accordance with the currently applicable statutory regulations. All our products are packaged in such a way that the individually packed goods (pallets) can be shipped.

We wish to point out that our packaging is not suitable for individual shipments via parcel post. The manufacturer shall accept no liability for damages incurred as a result of improper packaging in an individual shipment.

VI. Manufacturer's warranty

The manufacturer's warranty shall apply only if installation, operation and maintenance have been carried out in full accordance with the manufacturer's specifications in the installation and operating instructions.

- The warranty period shall commence from the date on which proof of purchase is provided and shall be limited, in all cases, to 24 months.
- Warranty services shall be performed only if proof of purchase of the equipment can be presented.
- Any and all warranty claims shall become void if modifications are made to the equipment without the manufacturer's express consent.
- Any warranty claim shall likewise become void in the case of defects that arise due to repairs or interventions made by unauthorised persons or due to improper use.
- In the case of warranty claims, the serial and article numbers must be provided, together with the unit designation and a meaningful description of the error.
- This warranty shall cover defective equipment parts, with the exception of normal wear parts. Wear parts shall include, for example, light

General terms and conditions of service

sources, glass elements, tubular heating elements and sauna heater stones.

- Only original spare parts may be used within the warranty period.
- Service visits made by third parties shall require a written order issued by our service department.
- The equipment in question shall be sent to our service department by the customer at the customer's own expense.
- Electrical assembly and installation work, including service visits and parts replacements, shall be carried out at the customer's expense; costs shall not be borne by the manufacturer.

Complaints in respect of our products shall be reported to the responsible distributor and shall be handled exclusively by said distributor.

The manufacturer's General Terms and Conditions of Business, in the version available at www.eos-sauna.com/agb, shall apply in addition to the foregoing terms and conditions of service.

8

Disposal



Electrical devices that are no longer needed must be recycled at a recycling station as per EU guideline 2012/19/EU or as per the Electrical and Electronic Equipment Act (ElektroG). Observe local provisions, laws, regulations, standards and directives when disposing of the unit.



Do not dispose of the unit with household waste.



Packaging

The packaging of the control unit can be completely separated for disposal and recycled. The following materials are used in the packaging:

- Used paper, cardboard
- Plastic foil
- Foam material

Electronic waste

Electronic waste must be disposed of at the designated local collection point for electronic waste.

Service address

EOS Saunatechnik GmbH

Schneiderstriesch 1

35759 Driedorf, Germany

Tel. +49 2775 82-514

Fax +49 2775 82-431

Email service@eos-sauna.com

Web www.eos-sauna.com

Store this address with the installation instructions in a safe place.
Please always provide us with nameplate data, such as model, item number and serial number so we can provide fast and efficient support.

Date of sale

Stamp/retailer signature: